



Get Organised™

**PRODUCT  
CATALOGUE  
2024/25**

**DESIGNED IN SWEDEN**





## SMART MENU

Click or tap each icon to navigate the catalogue.



➔ **WELCOME**  
TO OUR WORLD

➔ **DESIGNED IN**  
**SWEDEN**

➔ **STREAMLINE**  
YOUR WORKFLOW

➔ **LIFETIME**  
GUARANTEE

➔ **GET ORGANISED™**  
FOR A BETTER **WORKFLOW**

All prices displayed in this catalogue are excluding VAT and subject to availability.  
Prices are valid until the 31st of December, 2025

Home



TT Series Tool Kits



TT Series - Tool Control System



FOAM Series Tool Kits



FOAM Series - Tool Control System



Other Tool Sets



Tool Storage



Socket Sets



Sockets & Accessories



Torque Tools



Spanners & Wrenches



Screwdrivers



Bits & Drivers



Hex & Tx Keys



Pliers



Insulated Tools



Cutting Tools



Measuring Tools



Auto Tools



Service Tools



Air Tools







# WELCOME TO OUR WORLD

When you choose TengTools you immediately stand out from the crowd as an individual who is intent on achieving their goals.

TengTools offer a modular tool system that is built to last. Build your ultimate tool kit with our large selection of storage and tool sets enabling customised tool solutions for any kind of industry or profession.

Get Organised™ with a tool control system designed to boost efficiency and save time.





# DESIGNED IN SWEDEN

**QUALITY PRODUCTS THAT COMBINE  
SWEDISH DESIGN AND ENGINEERING WITH  
A STRONG ENVIRONMENTAL AWARENESS.**

At TengTools, our products reflect the precision, durability, and reliability that Swedish engineering is known for. Designed with a focus on quality and sustainability.

We prioritise functionality, ergonomic design, and long-lasting performance—ensuring that each tool not only meets, but exceeds, the demands of professionals worldwide.

With a focus on sustainability, when you Get Organised™ with TengTools, you minimize the need to replace tools. That is sustainability in a nutshell.





- 
- 
- 
- 
- 
- 
- 
- 
- 
- 
- 
- 
- 
- 
- 
- 
- 
- 
- 
- 
- 
- 

# STREAMLINE YOUR WORKFLOW

**TAILOR YOUR TOOL SOLUTION TO YOUR NEEDS**

TengTools offer a modular tool system that is built to last.

Build your ultimate tool kit with our large selection of storage and tool sets enabling customised tool solutions for any kind of industry or profession.

Don't waste space and money on tools you don't need. Buy the exact tools you require and if you need more in the future, just add new sets that fit seamlessly into your storage solution.

When you purchase TengTools you are guaranteed the highest quality. If a tool is worn out or if you happen to lose a piece, individual tools can be easily purchased as replacements.







# LIFETIME GUARANTEE

## QUALITY IS EVERYTHING

All our tools meet – or exceed – the demands in ISO, DIN and other international standards. As an extra security for you, our tools are offered with a guarantee against material and manufacturing defects during the normal lifetime of the product in question. Defective products covered by the guarantee will be repaired or replaced.

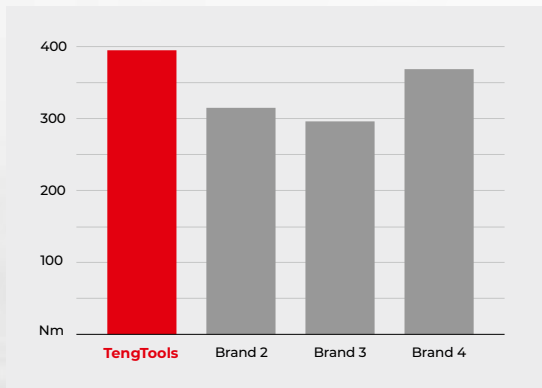

Adjustable wrench Comparison test. May 14, 2020. Torque breaking point (Nm). ISO 6787:2018.

## Proven to be better.

Independent tests have shown that our tools not only exceed the international quality standards – they are best in class. TengTools was positioned first or second in all of the eight product categories tested.





\* Defects or performance issues caused by accidents, not approved modifications, misuse, normal wear & tear or lack of proper care are excluded.

A guarantee claim requires the submission or shipment of the complete product to the retailer or distributor along with a receipt or invoice validating the purchase date and the product designation. Returned products are first managed by the distributor network, entrusted with applying TengTools' warranty conditions. Replacement or repair of the product will be carried out as quickly as possible.





# FOR A BETTER WORKFLOW

## BENEFITS OF A WELL-ORGANISED HAND TOOL SOLUTION:



**Time Saving:** An organised tool storage system can help you save time by reducing the time you spend searching for tools. When you have a designated spot for every tool, you can quickly locate the one you need.



**Increased productivity:** An organised workspace can help you work more efficiently and effectively. When you have a clear idea of where each tool is located, you can work faster, and the time you save can be used to complete more tasks.



**Improved safety:** A disorganised tool storage system can lead to accidents, such as tripping or falling, and injuries caused by misplaced tools. An organised system, on the other hand, reduces the chances of accidents and ensures that each tool is in its designated place, making it less likely to be left lying around where it could cause harm.



**Cost-effective:** An organised tool storage system can help you avoid buying tools you already have or replacing lost ones, saving you money in the long run.



**Better tool longevity:** When tools are stored properly, they are less likely to suffer damage from being knocked around or exposed to moisture or extreme temperatures. This means that they will last longer and perform better.



**Sustainability:** When you Get Organised™ with our long-lasting tools, you minimize the need to purchase replacements. That is sustainability in a nutshell.



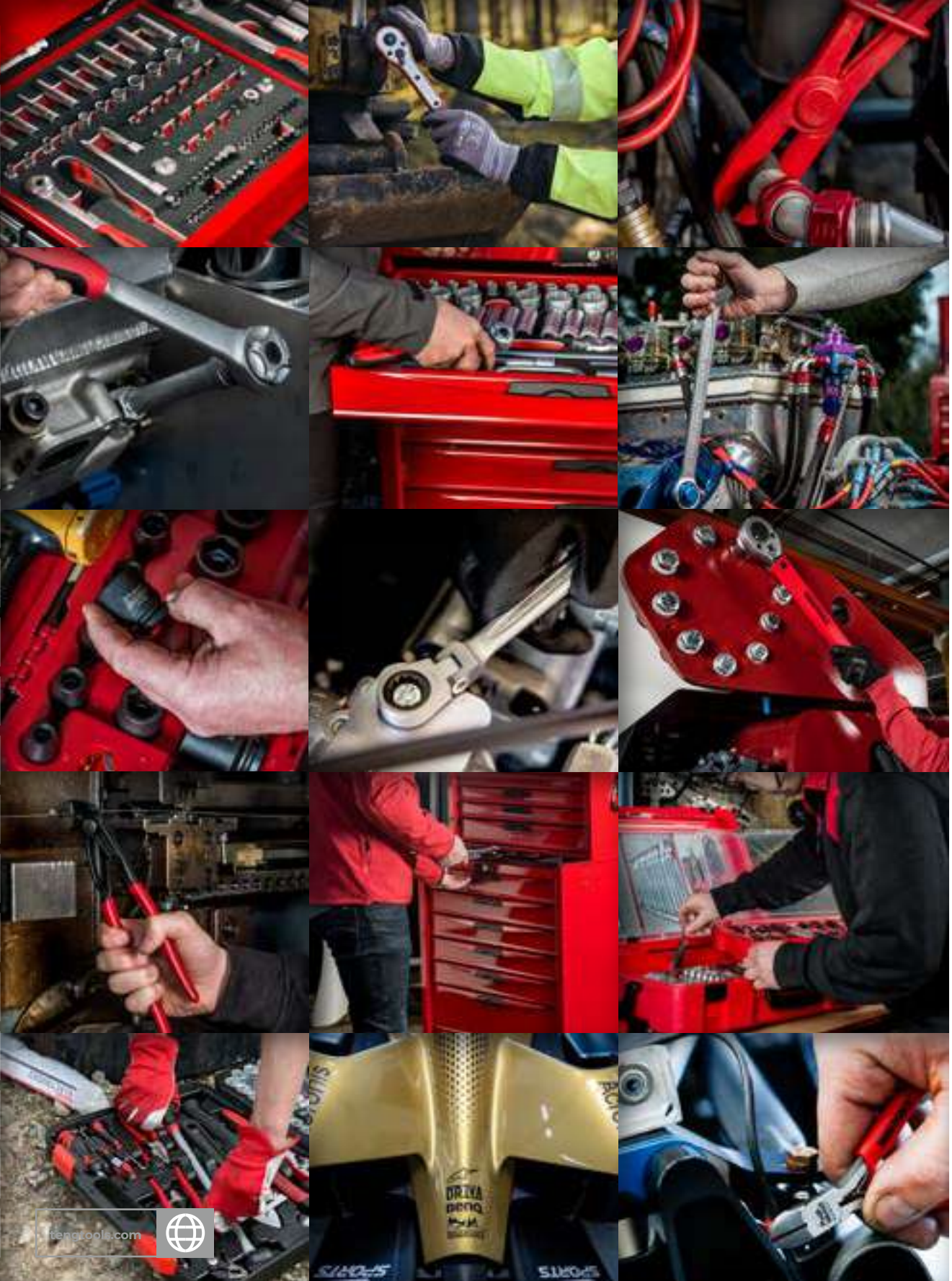

# TT SERIES TOOL KITS

## BETTER TOOLS BRING BETTER RESULTS

Each tool kit has been compiled with the help of technicians from various trades and are available in many shapes and sizes. From full stacks to roller cabinets, and top boxes to portable solutions, there is a kit to fit your exact needs

### TT SERIES

---



**Space-saving:** The TT Series allows you to fit more tools in each drawer.



**Durability:** TT Series tool trays are made from a durable recyclable plastic that can withstand heavy use and are resistant to wear and tear.



**Easy to clean:** TT Series tool trays can be easily wiped clean with a damp cloth, making them simple to maintain and keep clean.



**Lightweight:** TT Series tool trays are lightweight, making the toolkit easier to move around and transport as required.



**Corrosion-resistant:** TT Series tool trays are resistant to corrosion, making them ideal for use in humid or damp environments.









**PRO35™**

**MONSTER™**

**NEW**

**53" PRO35™ MONSTER STACK TOOL KIT 1295 PIECES RED**

**1295**  
PIECES

**TT**  
SERIES



- 19** Drawer
- 3-Piece Cabinet Frame**
- Heavy Gauge Steel**
- 5-Step Phosphate-Free Rust Protection**
- 53" Wide Cabinet**
- 6" x 2" Castor Wheels with Brakes**
- 3 Step Ball Bearing Slides**
- Comfort Grip Handle**
- Combination Lock**







Drawer	Item ID	Description
	TSW53R9	53" PRO35™ roller cabinet 9 drawers red
	TST53R10F	53" PRO35™ tool chest 10 drawers red
	TCF07	Fixing brackets for 26", 37" & 53" deep tool chest
	580T	Side shelf for roller cabinet 457 x 100 x 50mm
1/10	TTD914N	Screwdriver Set Mixed TT2
1/10	TT1448	1/4" Socket & Bits Set TT1
1/10	TTMD74	Ratcheting Screwdriver Bit Set TT1
1/10	TTX918N	Screwdriver Set Flat & PH TTX4
2/10	TTD912TXN	Screwdriver Set TX TT2
2/10	TTM116	Mini Pliers & Screwdriver Set TT1
2/10	TT01	Storage Tray TT1 7 Compartments
2/10	TTXMDTN	Power Through Screwdriver Set TTX4
3/10	TT1435	1/4" Socket Set 6 pt TT1
3/10	TT3819	3/8" Socket Set 6 pt TT1
3/10	TT1205	1/2" Ratchet & Accessories Set TT1
3/10	TT1217	1/2" Socket Set 12 pt TT1
3/10	TTXEXT13	Extension Bars Set TTX4
4/10	TTAF32	1/4" & 3/8" Socket Set AF 6 pt TT1
4/10	TT1215AF	1/2" Socket Set 12 pt AF TT1
4/10	TT1211	1/2" Deep Socket Set 12 pt TT1
4/10	TT3816	3/8" Socket Set 6 pt TT1
4/10	TTX00	Storage Tray TTX4 1 Compartment
5/10	TTHEX7	T-Handle Ball Point Hex Key Set TT1
5/10	TTHEX7AF	T-Handle Ball Point Hex Key Set AF TT1
5/10	TTTX7	T-Handle TX/TPX Key Set TT1
5/10	TTHT28	Ball Point Hex & TX Key Set TT1
5/10	TTX03	Storage Tray TTX4 8 Compartments
6/10	TTD441Q	Plier Set Vinyl Grip Q TT2
6/10	TT474-7E	Circlip Plier Set PRO 19-60 mm TT1
6/10	TTADP17	Socket Adaptor Set TT1
6/10	TTX474-9E	Circlip Plier Set PRO 40-100 mm TTX4
7/10	TTTM03	Inspection Set TT1
7/10	TTBM	Measuring Tool Set TT1
7/10	TTSR04	Scraper Set TT1
7/10	TTNF12	Needle File Set TT1
7/10	TTXF05	Hand File Set TTX4
8/10	TTDCT05	Cutting Tool Set TT2
8/10	TTPC09	Punch & Chisel Set TT1
8/10	TTK40	Knife Set TT1
8/10	TTXMD41N	Socket & Bit Set Flexible Handle TTX4
9/10	TT6508R	Ratcheting Combination Spanner Set R TT1
9/10	TT6208	Double Open Ended Spanner Set TT1
9/10	TT6010M	Stubby Combination Spanner Set TT1
9/10	TT1236	Combination Spanner Set TT1
9/10	TTX2032	Combination Spanner Set TTX4

Drawer	Item ID	Description
10/10	TT3592	Combination Spanner Set AF TT1
10/10	TTRORS	Ratcheting Ring Spanner Set TT1
10/10	TT6506	Double Flex Wrench Set TT1
10/10	TTBS35	1/4" & 3/8" Bit Socket Set TT1
10/10	TTX2640	Combination Spanner Set AF TTX4
1/9	TTD9416	3/4 Impact Socket Set DIN TT2
1/9	TT9015HX	3/8" & 1/2" Hex Impact Socket Set DIN TT1
1/9	TT9024	1/4" & 3/8" Impact Socket Set ANSI TT1
1/9	TTX3402E	1/4" Ratchet & Accessories Set TTX4
1/9	TT9116N	1/2" Impact Socket Set ANSI TT1
1/9	TT9212TX	1/2" TX Impact Socket Set DIN TT1
1/9	TT9207	1/2" Impact Socket Accessories Set DIN TT1
1/9	TTID20	1/2" Impact Driver Set TT1
1/9	TTX3414	3/4" Socket Set 6 pt TTX4
2/9	TTV3814	3/8" Insulated Socket Set TT1
2/9	TTV710N	Insulated Screwdriver Set Interchangeable Blades TT1
2/9	TTV440	Insulated Plier Set TT1
2/9	TTHEX23	1/2" Hex Bit Socket Set TT1
2/9	TTXND	Nut Driver Set TTX4
3/9	TTVG05	Power Grip Plier Set TT1
3/9	TTADJ04	Adjustable Wrench Set TT1
3/9	TTCP04	Crimping Plier Set TT1
3/9	TTCP121	Crimping Plier Set TT1
3/9	TTX6311	Double Ring Spanner Set TTX4
4/9	TTPS09	General Tool Set BP TT4
4/9	TTX2493	1/2" Torque Wrench & Breaker Bar Set TTX4
5/9	TTSPG	Power Grip Plier Set TT4
5/9	TTX3892	3/8" Torque Wrench Set 20-110 Nm TTX4
6/9	TTDTD34	Tap and Die Set TT2
6/9	TTD01	Storage Tray TT2 8 Compartments
6/9	TTX01	Storage Tray TTX4 6 Compartments
7/9	TTNR81	Nutsert Gun Set TT1
7/9	TTHR81	Rivet Gun Set TT1
7/9	TTHP08	Hook & Pin Wrench Set TT1
7/9	TTBE18	Stud Extractor Set TT1
7/9	TTXPB3	Pry Bar Set Roll/Heel TTX4
8/9	TTOS16	Oil Service Set TT1
8/9	TTSN11	Extractor & Nut Splitter Set TT1
8/9	TT804	Puller Set TT1
8/9	TTHC03	Hose Clamp Set TT1
8/9	TTXPB3A	Pry Bar Set TTX4
9/9	EMPTY	
Side shelf	3401	3/4" Breaker Bar

Item ID: **TKS53R1295T**







**PRO35™**

**MEGA MASTER™**

**NEW**

26" PRO35™ MEGA MASTER TOOL KIT, 1033 PIECES, RED

**1033**  
PIECES

TT  
SERIES

- 16** Drawer
- 3-Piece Cabinet Frame**
- Heavy Gauge Steel**
- 5-Step Phosphate-Free Rust Protection**
- 26" Wide Cabinet**
- 5" x 1-1/4" Castor Wheels with Brakes**
- 3 Step Ball Bearing Slides**
- Comfort Grip Handle**
- Combination Lock**

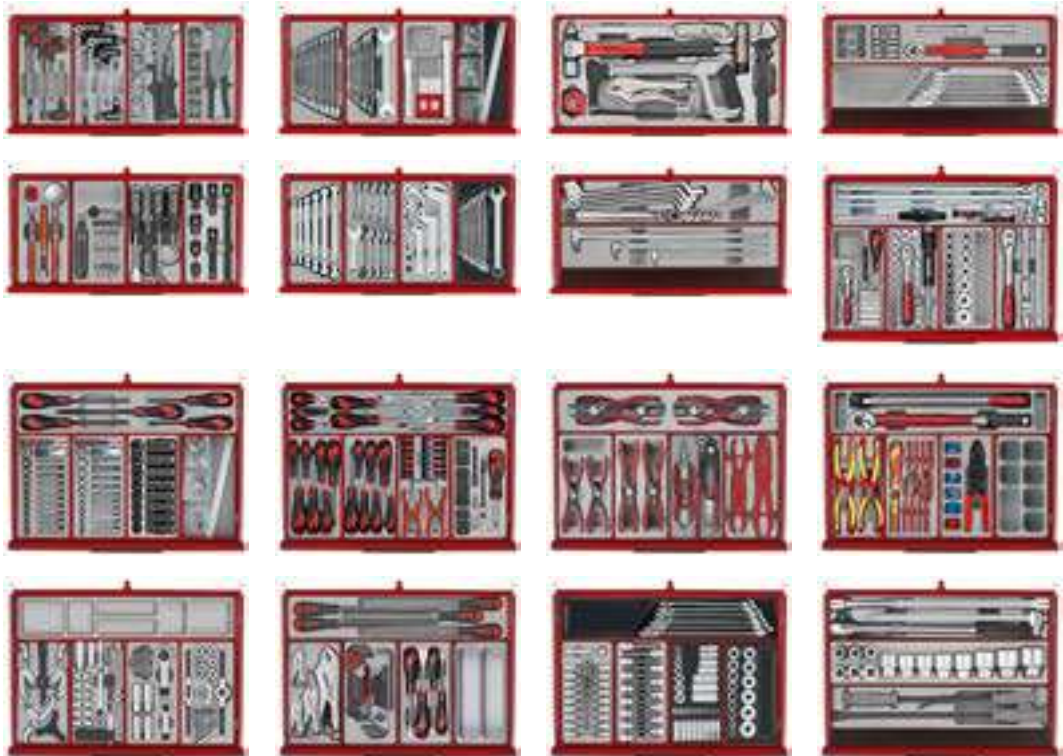



Drawer	Item ID	Description
	TST26R4	26" PRO35™ tool chest 4 drawers red
	TSM26R3	26" PRO35™ tool chest 3 drawers red
	TSW26R9	26" PRO35™ roller cabinet 9 drawers red
	TCF05	Fixing brackets for 26" 3-drawer tool chest
	TCA08	Paper roll holder for side handle
	580	Magnetic Bits Tray Round
1/4	TTHEX7	T-Handle Ball Point Hex Key Set TT1
1/4	TTTX7	T-Handle TX/TPX Key Set TT1
1/4	TTNR81	Nutsert Gun Set TT1
1/4	TTHR81	Rivet Gun Set TT1
2/4	TTI236	Combination Spanner Set TT1
2/4	TT6208	Double Open Ended Spanner Set TT1
2/4	TTPC09	Punch & Chisel Set TT1
2/4	TTALU	Clip Rail Set TT1
3/4	TTPS09	General Tool Set BP TT4
4/4	TTX3892	3/8" Torque Wrench Set 20-110 Nm TTX4
4/4	TTX2032	Combination Spanner Set TTX4
1/3	TTTM03	Inspection Set TT1
1/3	TTID20	1/2" Impact Driver Set TT1
1/3	TTSR04	Scraper Set TT1
1/3	TT9207A	1/2" Impact Socket Accessories Set ANSI TT1
2/3	TT6506	Double Flex Wrench Set TT1
2/3	TT6010M	Stubby Combination Spanner Set TT1
2/3	TTHP08	Hook & Pin Wrench Set TT1
2/3	TT3592	Combination Spanner Set AF TT1
3/3	TTX6311	Double Ring Spanner Set TTX4
3/3	TTXPB3	Pry Bar Set Roll/Heel TTX4
1/9	TTI435	1/4" Socket Set 6 pt TT1
1/9	TT3819	3/8" Socket Set 6 pt TT1
1/9	TTI217-6	1/2" Socket Set 6 pt TT1
1/9	TTI205	1/2" Ratchet & Accessories Set TT1
1/9	TTXEXT13	Extension Bars Set TTX4
2/9	TTTX23	1/2" TX Bit Socket Set TT1
2/9	TTHEX23	1/2" Hex Bit Socket Set TT1
2/9	TT9116N	1/2" Impact Socket Set ANSI TT1
2/9	TTALU	Clip Rail Set TT1
2/9	TTXMDTN	Power Through Screwdriver Set TTX4

Drawer	Item ID	Description
3/9	TT917N	Screwdriver Set Mixed TT1
3/9	TT917TXN	Screwdriver Set TX & TPX TT1
3/9	TTM116	Mini Pliers & Screwdriver Set TT1
3/9	TTMD74	Ratcheting Screwdriver Bit Set TT1
3/9	TTX918N	Screwdriver Set Flat & PH TTX4
4/9	TT474-5E	Circlip Plier Set PRO 12-25 mm TT1
4/9	TT474-7E	Circlip Plier Set PRO 19-60 mm TT1
4/9	TT440Q	Plier Set Vinyl Grip Q TT1
4/9	TTHC03	Hose Clamp Set TT1
4/9	TTX474-9E	Circlip Plier Set PRO 40-100 mm TTX4
5/9	TTV440	Insulated Plier Set TT1
5/9	TTV710N	Insulated Screwdriver Set Interchangeable Blades TT1
5/9	TTCP121	Crimping Plier Set TT1
5/9	TT01	Storage Tray TT1 7 Compartments
5/9	TTX2493	1/2" Torque Wrench & Breaker Bar Set TTX4
6/9	TT804	Puller Set TT1
6/9	TTOS16	Oil Service Set TT1
6/9	TTSN11	Extractor & Nut Splitter Set TT1
6/9	TTTD17	Tap and Die Set TT1
6/9	TTX01	Storage Tray TTX4 6 Compartments
7/9	TTVG05	Power Grip Plier Set TT1
7/9	TTHT28	Ball Point Hex & TX Key Set TT1
7/9	TTSR04A	Clip & Panel Remover Set TT1
7/9	TT02	Storage Tray TT1 2 Compartments
7/9	TTXF05	Hand File Set TTX4
8/9	TTTX30	3/8" TX Bit Socket Set TT1
8/9	TTRS15	1/2" Long Ribe & XZN Bit Socket Set TT1
8/9	TTAF32	1/4" & 3/8" Socket Set AF 6 pt TT1
8/9	TTI215AF	1/2" Socket Set 12 pt AF TT1
8/9	TTX2640	Combination Spanner Set AF TTX4
9/9	TTXPB3A	Pry Bar Set TTX4
9/9	TTX3414	3/4" Socket Set 6 pt TTX4
9/9	TTX3404	3/4" Ratchet & Accessories Set TTX4



Item ID: **TKS26R1033T**





PRO35™

MEGA MASTER™

NEW

26" PRO35™ MEGA MASTER TOOL KIT 1033 PIECES BLACK

1033  
PIECES

TT  
SERIES

- 16 Drawer
- 3-Piece Cabinet Frame
- Heavy Gauge Steel
- 5-Step Phosphate-Free Rust Protection
- 26" Wide Cabinet
- 5" x 1-1/4" Castor Wheels with Brakes
- 3 Step Ball Bearing Slides
- Comfort Grip Handle
- Combination Lock

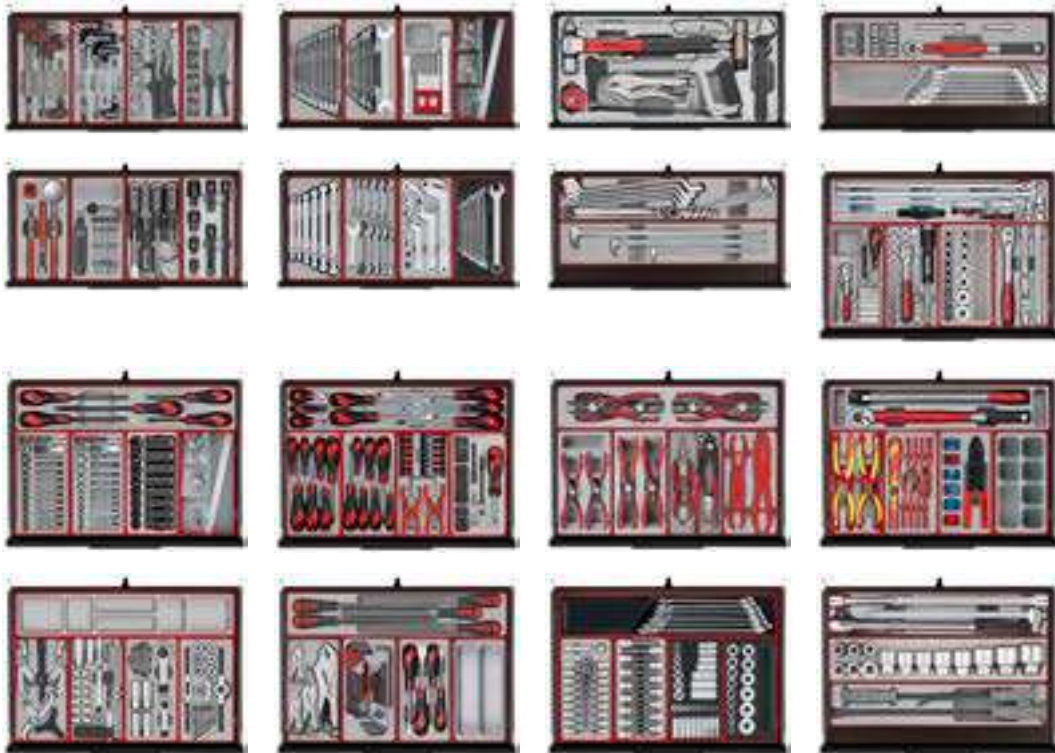



Drawer	Item ID	Description
	TST26B4	26" PRO35™ tool chest 4 drawers black
	TSM26B3	26" PRO35™ tool chest 3 drawers black
	TSW26B9	26" PRO35™ roller cabinet 9 drawers black
	TCF05	Fixing brackets for 26" 3-drawer tool chest
	TCA08	Paper roll holder for side handle
	580	Magnetic Bits Tray Round
1/4	TTHEX7	T-Handle Ball Point Hex Key Set TT1
1/4	TTTX7	T-Handle TX/TPX Key Set TT1
1/4	TTNR81	Nutsert Gun Set TT1
1/4	TTHR81	Rivet Gun Set TT1
2/4	TTI236	Combination Spanner Set TT1
2/4	TT6208	Double Open Ended Spanner Set TT1
2/4	TTPC09	Punch & Chisel Set TT1
2/4	TTALU	Clip Rail Set TT1
3/4	TTPS09	General Tool Set BP TT4
4/4	TTX3892	3/8" Torque Wrench Set 20-110 Nm TTX4
4/4	TTX2032	Combination Spanner Set TTX4
1/3	TTTM03	Inspection Set TT1
1/3	TTID20	1/2" Impact Driver Set TT1
1/3	TTSR04	Scraper Set TT1
1/3	TT9207A	1/2" Impact Socket Accessories Set ANSI TT1
2/3	TT6506	Double Flex Wrench Set TT1
2/3	TT6010M	Stubby Combination Spanner Set TT1
2/3	TTHP08	Hook & Pin Wrench Set TT1
2/3	TT3592	Combination Spanner Set AF TT1
3/3	TTX6311	Double Ring Spanner Set TTX4
3/3	TTXPB3	Pry Bar Set Roll/Heel TTX4
1/9	TT1435	1/4" Socket Set 6 pt TT1
1/9	TT3819	3/8" Socket Set 6 pt TT1
1/9	TT1217-6	1/2" Socket Set 6 pt TT1
1/9	TT1205	1/2" Ratchet & Accessories Set TT1
1/9	TTXEXT13	Extension Bars Set TTX4
2/9	TTTX23	1/2" TX Bit Socket Set TT1
2/9	TTHEX23	1/2" Hex Bit Socket Set TT1
2/9	TT9116N	1/2" Impact Socket Set ANSI TT1
2/9	TTALU	Clip Rail Set TT1
2/9	TTXMDTN	Power Through Screwdriver Set TTX4

Drawer	Item ID	Description
3/9	TT917N	Screwdriver Set Mixed TT1
3/9	TT917TXN	Screwdriver Set TX & TPX TT1
3/9	TTM116	Mini Pliers & Screwdriver Set TT1
3/9	TTMD74	Ratcheting Screwdriver Bit Set TT1
3/9	TTX918N	Screwdriver Set Flat & PH TTX4
4/9	TT474-5E	Circlip Plier Set PRO 12-25 mm TT1
4/9	TT474-7E	Circlip Plier Set PRO 19-60 mm TT1
4/9	TT440Q	Plier Set Vinyl Grip Q TT1
4/9	TTHC03	Hose Clamp Set TT1
4/9	TTX474-9E	Circlip Plier Set PRO 40-100 mm TTX4
5/9	TTV440	Insulated Plier Set TT1
5/9	TTV710N	Insulated Screwdriver Set Interchangeable Blades TT1
5/9	TTCP121	Crimping Plier Set TT1
5/9	TT01	Storage Tray TT1 7 Compartments
5/9	TTX2493	1/2" Torque Wrench & Breaker Bar Set TTX4
6/9	TT804	Puller Set TT1
6/9	TTOS16	Oil Service Set TT1
6/9	TTSN11	Extractor & Nut Splitter Set TT1
6/9	TTTD17	Tap and Die Set TT1
6/9	TTX01	Storage Tray TTX4 6 Compartments
7/9	TTVG05	Power Grip Plier Set TT1
7/9	TTHT28	Ball Point Hex & TX Key Set TT1
7/9	TTSR04A	Clip & Panel Remover Set TT1
7/9	TT02	Storage Tray TT1 2 Compartments
7/9	TTXF05	Hand File Set TTX4
8/9	TTTX30	3/8" TX Bit Socket Set TT1
8/9	TTRS15	1/2" Long Ribe & XZN Bit Socket Set TT1
8/9	TTAF32	1/4" & 3/8" Socket Set AF 6 pt TT1
8/9	TT1215AF	1/2" Socket Set 12 pt AF TT1
8/9	TTX2640	Combination Spanner Set AF TTX4
9/9	TTXPB3A	Pry Bar Set TTX4
9/9	TTX3414	3/4" Socket Set 6 pt TTX4
9/9	TTX3404	3/4" Ratchet & Accessories Set TTX4



Item ID: **TKS26B1033T**





**PRO35™**

**26" PRO35™ STACK TOOL KIT 1034 PIECES RED**

1034  
PIECES

TT  
SERIES

- 14 Drawer
- 3-Piece Cabinet Frame
- Heavy Gauge Steel
- 5-Step Phosphate-Free Rust Protection
- 26" Wide Cabinet
- 5" x 1-1/4" Castor Wheels with Brakes
- 3 Step Ball Bearing Slides
- Comfort Grip Handle
- Combination Lock

**NEW**

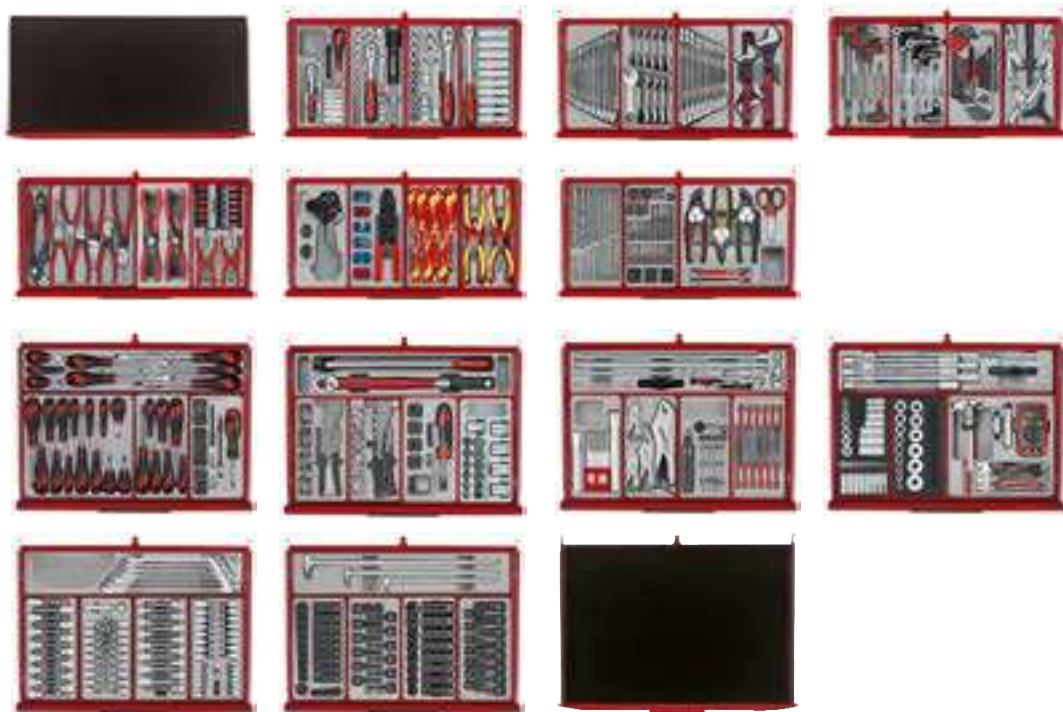





Drawer	Item ID	Description
	TST26R4	26" PRO35™ tool chest 4 drawers red
	TSM26R3	26" PRO35™ tool chest 3 drawers red
	TSW26R7	26" PRO35™ roller cabinet 7 drawers red
	TCF05	Fixing brackets for 26" 3-drawer tool chest
	TCA08	Paper roll holder for side handle
1/4	EMPTY	
2/4	TT143512	1/4" Socket Set 12 pt TT1
2/4	TT381912	3/8" Socket Set 12 pt TT1
2/4	TT1218	1/2" Socket Set 12 pt TT1
2/4	TT1211	1/2" Deep Socket Set 12 pt TT1
3/4	TT1236	Combination Spanner Set TT1
3/4	TT6010MRS	Stubby Ratcheting Combination Spanner Set TT1
3/4	TT6511R	Ratcheting Combination Spanner Set R TT1
3/4	TTADJ04	Adjustable Wrench Set TT1
4/4	TTHEX7	T-Handle Ball Point Hex Key Set TT1
4/4	TTTX7	T-Handle TX/TPX Key Set TT1
4/4	TTHT28	Ball Point Hex & TX Key Set TT1
4/4	TT804	Puller Set TT1
1/3	TTD441Q	Plier Set Vinyl Grip Q TT2
1/3	TT474-7E	Circlip Plier Set PRO 19-60 mm TT1
1/3	TTM116	Mini Pliers & Screwdriver Set TT1
2/3	TTCP04	Crimping Plier Set TT1
2/3	TTCP121	Crimping Plier Set TT1
2/3	TTV907N	Insulated Screwdriver Set Mixed TT1
2/3	TTV440	Insulated Plier Set TT1
3/3	TTDB28	Drill Bit Set 1.0-13.0 mm TT1
3/3	TTB553	Impact Bit Set TT1
3/3	TTDCT06	Cutting Tool Set TT2
1/7	TTD914N	Screwdriver Set Mixed TT2
1/7	TT9171XN	Screwdriver Set TX & TPX TT1
1/7	TTMD74	Ratcheting Screwdriver Bit Set TT1
1/7	TTX918N	Screwdriver Set Flat & PH TTX4
2/7	TTHR81	Rivet Gun Set TT1
2/7	TTNR81	Nutsert Gun Set TT1
2/7	TTSD38	Torque Screwdriver Set TT1
2/7	TTBE18	Stud Extractor Set TT1
2/7	TTX2493	1/2" Torque Wrench & Breaker Bar Set TTX4

Drawer	Item ID	Description
3/7	TTPC09	Punsch & Chisel Set TT1
3/7	TTVG05	Power Grip Plier Set TT1
3/7	TTID20	1/2" Impact Driver Set TT1
3/7	TTNF12	Needle File Set TT1
3/7	TTXEXT13	Extension Bars Set TTX4
4/7	TTAF32	1/4" & 3/8" Socket Set AF 6 pt TT1
4/7	TT1215AF	1/2" Socket Set 12 pt AF TT1
4/7	TTDCM	Measuring Tool Set TT2
4/7	TTXTB09	3/8" Long T Bar Socket Set TTX4
5/7	TTTXH15	1/2" Long Hex & TX Bit Socket Set TT1
5/7	TTTX30	3/8" TX Bit Socket Set TT1
5/7	TTRS15	1/2" Long Ribe & XZN Bit Socket Set TT1
5/7	TTBS35	1/4" & 3/8" Bit Socket Set TT1
5/7	TTX2032	Combination Spanner Set TTX4
6/7	TT9024	1/4" & 3/8" Impact Socket Set ANSI TT1
6/7	TT9212TX	1/2" TX Impact Socket Set DIN TT1
6/7	TT9116N	1/2" Impact Socket Set ANSI TT1
6/7	TT9015HX	3/8" & 1/2" Hex Impact Socket Set DIN TT1
6/7	TTXPB3	Pry Bar Set Roll/Heel TTX4
7/7	EMPTY	



Item ID: **TKS26R1034T**







**PRO35™**

**26" PRO35™ STACK TOOL KIT 753 PIECES RED**

**753**  
PIECES

**TT**  
SERIES

**NEW**

- 16 Drawer
- 3-Piece Cabinet Frame
- Heavy Gauge Steel
- 5-Step Phosphate-Free Rust Protection
- 26" Wide Cabinet
- 5" x 1-1/4" Castor Wheels with Brakes
- 3 Step Ball Bearing Slides
- Comfort Grip Handle
- Combination Lock

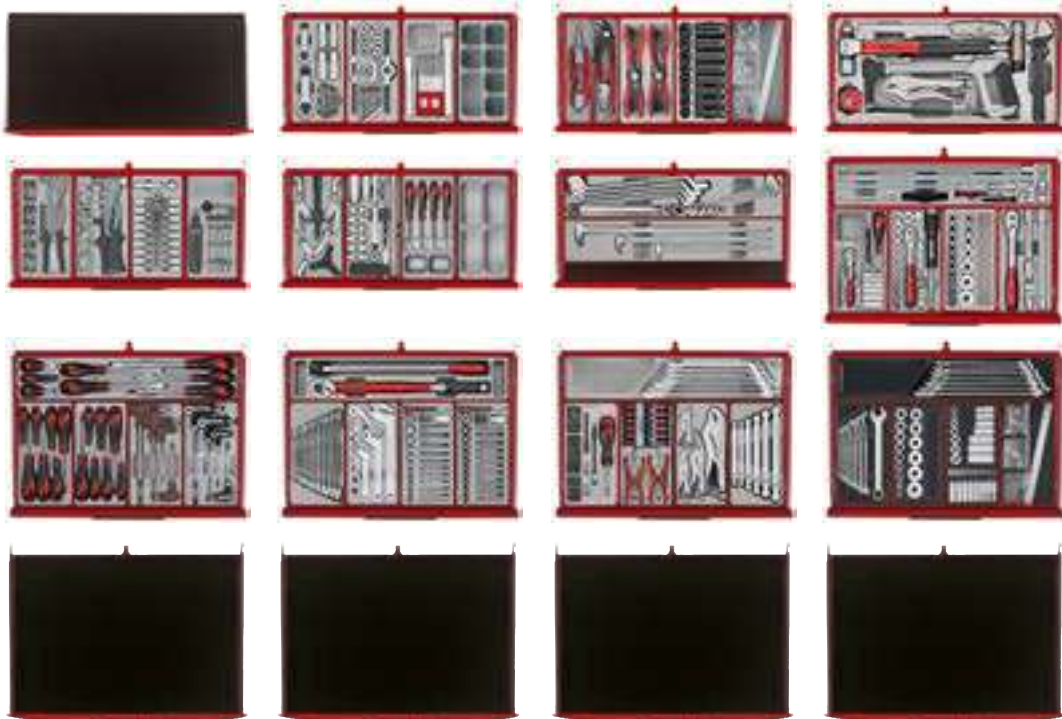



Drawer	Item ID	Description
	TST26R4	26" PRO35™ tool chest 4 drawers red
	TSM26R3	26" PRO35™ tool chest 3 drawers red
	TSW26R9	26" PRO35™ roller cabinet 9 drawers red
	TCF05	Fixing brackets for 26" 3-drawer tool chest
	TCA08	Paper roll holder for side handle
1/4	EMPTY	
2/4	TTSN11	Extractor & Nut Splitter Set TT1
2/4	TTTD17	Tap and Die Set TT1
2/4	TTPC09	Punch & Chisel Set TT1
2/4	TT01	Storage Tray TT1 7 Compartments
3/4	TT440Q	Plier Set Vinyl Grip Q TT1
3/4	TT474-7E	Circlip Plier Set PRO 19-60 mm TT1
3/4	TT9116N	1/2" Impact Socket Set ANSI TT1
3/4	TTALU	Clip Rail Set TT1
4/4	TTPS09	General Tool Set BP TT4
1/3	TTHR81	Rivet Gun Set TT1
1/3	TTNR81	Nutsert Gun Set TT1
1/3	TTTX30	3/8" TX Bit Socket Set TT1
1/3	TTID20	1/2" Impact Driver Set TT1
2/3	TT804	Puller Set TT1
2/3	TTOS16	Oil Service Set TT1
2/3	TTMDP	Hock & Pick Set TT1
2/3	TT03	Storage Tray TT1 4 Compartments
3/3	TTX6311	Double Ring Spanner Set TTX4
3/3	TTXPB3	Pry Bar Set Roll/Heel TTX4
1/9	TT1435	1/4" Socket Set 6 pt TT1
1/9	TT3819	3/8" Socket Set 6 pt TT1
1/9	TT1217-6	1/2" Socket Set 6 pt TT1
1/9	TT1205	1/2" Ratchet & Accessories Set TT1
1/9	TTXEXT13	Extension Bars Set TTX4
2/9	TT917N	Screwdriver Set Mixed TT1
2/9	TT917TXN	Screwdriver Set TX & TPX TT1
2/9	TTHEX7	T-Handle Ball Point Hex Key Set TT1
2/9	TTTX7	T-Handle TX/TPX Key Set TT1
2/9	TTX918N	Screwdriver Set Flat & PH TTX4

Drawer	Item ID	Description
3/9	TT1236	Combination Spanner Set TT1
3/9	TTHP08	Hook & Pin Wrench Set TT1
3/9	TTHEX23	1/2" Hex Bit Socket Set TT1
3/9	TTTX23	1/2" TX Bit Socket Set TT1
3/9	TTX2493	1/2" Torque Wrench & Breaker Bar Set TTX4
4/9	TTMD74	Ratcheting Screwdriver Bit Set TT1
4/9	TTM116	Mini Pliers & Screwdriver Set TT1
4/9	TTVG05	Power Grip Plier Set TT1
4/9	TT6506	Double Flex Wrench Set TT1
4/9	TTX2032	Combination Spanner Set TTX4
5/9	TT3592	Combination Spanner Set AF TT1
5/9	TT1215AF	1/2" Socket Set 12 pt AF TT1
5/9	TTAF32	1/4" & 3/8" Socket Set AF 6 pt TT1
5/9	TTX2640	Combination Spanner Set AF TTX4
5/9	TTALU	Clip Rail Set TT1
6/9	EMPTY	
7/9	EMPTY	
8/9	EMPTY	
9/9	EMPTY	



Item ID: **TKS26R753T**





# PRO35™

NEW

## 53" PRO35™ ROLLER CABINET TOOL KIT 615 PIECES RED

615  
PIECES

TT  
SERIES

- 9 Drawer
- 3-Piece Cabinet Frame
- Heavy Gauge Steel
- 5-Step Phosphate-Free Rust Protection
- 53" Wide Cabinet
- 6" x 2" Castor Wheels with Brakes
- 3 Step Ball Bearing Slides
- Comfort Grip Handle
- Combination Lock

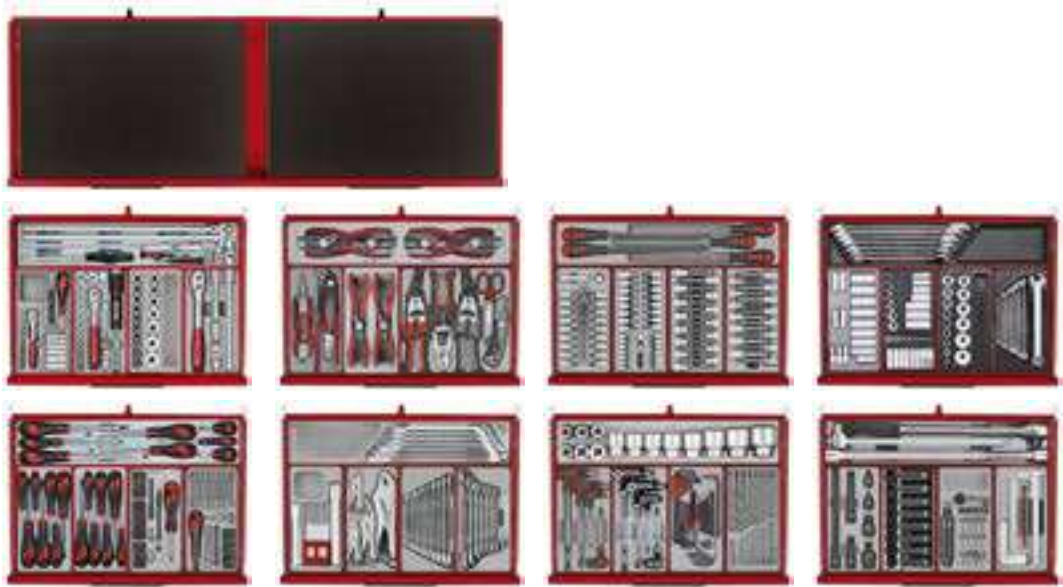



Drawer	Item ID	Description
	TSW53R9	53" PRO35™ roller cabinet 9 drawers red
	TCA08	Paper roll holder for side handle
1/9	EMPTY	
2/9	TT1435	1/4" Socket Set 6 pt TT1
2/9	TT3819	3/8" Socket Set 6 pt TT1
2/9	TT1217-6	1/2" Socket Set 6 pt TT1
2/9	TT1205	1/2" Ratchet & Accessories Set TT1
2/9	TTXEXT13	Extension Bars Set TTX4
3/9	TT440Q	Plier Set Vinyl Grip Q TT1
3/9	TT474-7E	Circlip Plier Set PRO 19-60 mm TT1
3/9	TTDCT05	Cutting Tool Set TT2
3/9	TTX474-9E	Circlip Plier Set PRO 40-100 mm TTX4
4/9	TTTX30	3/8" TX Bit Socket Set TT1
4/9	TTBS35	1/4" & 3/8" Bit Socket Set TT1
4/9	TTTXH15	1/2" Long Hex & TX Bit Socket Set TT1
4/9	TTRS15	1/2" Long Ribe & XZN Bit Socket Set TT1
4/9	TTXF05	Hand File Set TTX4
5/9	TT3816	3/8" Socket Set 6 pt TT1
5/9	TTAF32	1/4" & 3/8" Socket Set AF 6 pt TT1
5/9	TT1215AF	1/2" Socket Set 12 pt AF TT1
5/9	TT3592	Combination Spanner Set AF TT1
5/9	TTX2640	Combination Spanner Set AF TTX4
6/9	TT917N	Screwdriver Set Mixed TT1
6/9	TT917TXN	Screwdriver Set TX & TPX TT1
6/9	TTMD74	Ratcheting Screwdriver Bit Set TT1
6/9	TTMDQ49	Bits Driver Set TT1
6/9	TTX918N	Screwdriver Set Flat & PH TTX4

Drawer	Item ID	Description
7/9	TTPC09	Punsch & Chisel Set TT1
7/9	TTVG05	Power Grip Plier Set TT1
7/9	TT1236	Combination Spanner Set TT1
7/9	TT6508R	Ratcheting Combination Spanner Set R TT1
7/9	TTX2032	Combination Spanner Set TTX4
8/9	TTHEX7	T-Handle Ball Point Hex Key Set TT1
8/9	TTTTX7	T-Handle TX/TPX Key Set TT1
8/9	TTHT28	Ball Point Hex & TX Key Set TT1
8/9	TTDB28	Drill Bit Set 1.0-13.0 mm TT1
8/9	TTX3414	3/4" Socket Set 6 pt TTX4
9/9	TT9207	1/2" Impact Socket Accessories Set DIN TT1
9/9	TT9120DN	1/2" Impact Socket Set DIN TT1
9/9	TTID20	1/2" Impact Driver Set TT1
9/9	TTBM	Measuring Tool Set TT1
9/9	TTX3404	3/4" Ratchet & Accessories Set TTX4



Item ID: **TKW53R615T**





**PRO35™**

**NEW**

**37" PRO35™ ROLLER CABINET TOOL KIT 1008 PIECES BLACK**

**1008**  
PIECES

TT  
SERIES

- 8** Drawer
- 3-Piece Cabinet Frame**
- Heavy Gauge Steel**
- 5-Step Phosphate-Free Rust Protection**
- 37" Wide Cabinet**
- 5" x 2" Castor Wheels with Brakes**
- 3 Step Ball Bearing Slides**
- Comfort Grip Handle**
- Combination Lock**



\*Paper roll not included.

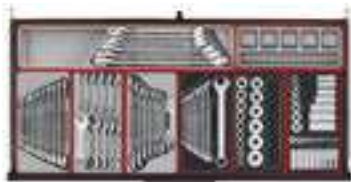



Drawer	Item ID	Description
	TSW37B8	37" PRO35™ roller cabinet 8 drawers black
	TC-TB03	Work Top for 37" Cabinet
	TCATV	Side Shelf for Vice
	TCA01	Paper Roll Holder
	TCAV4	4" Work Bench Vice
	580	Magnetic Bits Tray Round
1/8	TT1435	1/4" Socket Set 6 pt TT1
1/8	TT3819	3/8" Socket Set 6 pt TT1
1/8	TT3816	3/8" Socket Set 6 pt TT1
1/8	TTADP17	Socket Adaptor Set TT1
1/8	TTTX30	3/8" TX Bit Socket Set TT1
1/8	TT9015HX	3/8" & 1/2" Hex Impact Socket Set DIN TT1
1/8	TTXEXT13	Extension Bars Set TTX4
1/8	TTZ01	Storage Tray TTX2 6 Compartments
2/8	TT1205	1/2" Ratchet & Accessories Set TT1
2/8	TT1211	1/2" Deep Socket Set 12 pt TT1
2/8	TT1217-6	1/2" Socket Set 6 pt TT1
2/8	TTHEX16	1/2" Hex Bit Socket Set TT1
2/8	TTID20	1/2" Impact Driver Set TT1
2/8	TT9116N	1/2" Impact Socket Set ANSI TT1
2/8	TTX2493	1/2" Torque Wrench & Breaker Bar Set TTX4
2/8	TTZ01	Storage Tray TTX2 6 Compartments
3/8	TTHT28	Ball Point Hex & TX Key Set TT1
3/8	TT917TXN	Screwdriver Set TX & TPX TT1
3/8	TTHEX7	T-Handle Ball Point Hex Key Set TT1
3/8	TTTX7	T-Handle TX/TPX Key Set TT1
3/8	TTB553	Impact Bit Set TT1
3/8	TTMDR84	Ratcheting Bits Driver Set TT1
3/8	TTX918N	Screwdriver Set Flat & PH TTX4
3/8	TTZ01	Storage Tray TTX2 6 Compartments
4/8	TT1236	Combination Spanner Set TT1
4/8	TT6010M	Stubby Combination Spanner Set TT1
4/8	TT6508R	Ratcheting Combination Spanner Set R TT1
4/8	TT3592	Combination Spanner Set AF TT1
4/8	TT1215AF	1/2" Socket Set 12 pt AF TT1
4/8	TTAF32	1/4" & 3/8" Socket Set AF 6 pt TT1
4/8	TTX2032	Combination Spanner Set TTX4

Drawer	Item ID	Description
4/8	TTZ01	Storage Tray TTX2 6 Compartments
5/8	TTD441Q	Plier Set Vinyl Grip Q TT2
5/8	TT474-7E	Circlip Plier Set PRO 19-60 mm TT1
5/8	TTM116	Mini Pliers & Screwdriver Set TT1
5/8	TTHR81	Rivet Gun Set TT1
5/8	TTNR81	Nutsert Gun Set TT1
5/8	TTX474-9E	Circlip Plier Set PRO 40-100 mm TTX4
5/8	TTZVG03	Power Grip Plier Set TTX2
6/8	TTD914N	Screwdriver Set Mixed TT2
6/8	TTMDQ49	Bits Driver Set TT1
6/8	TTCP121	Crimping Plier Set TT1
6/8	TTV907N	Insulated Screwdriver Set Mixed TT1
6/8	TTV440	Insulated Plier Set TT1
6/8	TTX3892	3/8" Torque Wrench Set 20-110 Nm TTX4
6/8	TTZ01	Storage Tray TTX2 6 Compartments
7/8	TTPS09	General Tool Set BP TT4
7/8	TTSR04	Scraper Set TT1
7/8	TTTM03	Inspection Set TT1
7/8	TTX2640	Combination Spanner Set AF TTX4
7/8	TTZ01	Storage Tray TTX2 6 Compartments
8/8	TTPC09	Punch & Chisel Set TT1
8/8	TT804	Puller Set TT1
8/8	TTOS16	Oil Service Set TT1
8/8	TTDCM	Measuring Tool Set TT2
8/8	TTSR04A	Clip & Panel Remover Set TT1
8/8	TTXPB3A	Pry Bar Set TTX4
8/8	TTZ01	Storage Tray TTX2 6 Compartments



Item ID: **TKW37B1008T**







NEW

PRO35™

37" PRO35™ ROLLER CABINET TOOL KIT 663 PIECES RED

663  
PIECES

TT  
SERIES

- 7 Drawer
- 3-Piece Cabinet Frame
- Heavy Gauge Steel
- 5-Step Phosphate-Free Rust Protection
- 37" Wide Cabinet
- 5" x 2" Castor Wheels with Brakes
- 3 Step Ball Bearing Slides
- Comfort Grip Handle
- Combination Lock





Drawer	Item ID	Description
	TSW37R7	37" PRO35™ roller cabinet 7 drawers red
	TC-TB03	Work Top for 37" Cabinet
	TCA08	Paper roll holder for side handle
1/7	TT1435	1/4" Socket Set 6 pt TT1
1/7	TT3819	3/8" Socket Set 6 pt TT1
1/7	TT1205	1/2" Ratchet & Accessories Set TT1
1/7	TT1217-6	1/2" Socket Set 6 pt TT1
1/7	TTHEX7	T-Handle Ball Point Hex Key Set TT1
1/7	TTTX7	T-Handle TX/TPX Key Set TT1
1/7	TTXEXT13	Extension Bars Set TTX4
1/7	TTZ01	Storage Tray TTX2 6 Compartments
2/7	TT1236	Combination Spanner Set TT1
2/7	TTOS16	Oil Service Set TT1
2/7	TTSN11	Extractor & Nut Splitter Set TT1
2/7	TT440Q	Plier Set Vinyl Grip Q TT1
2/7	TT474-7E	Circlip Plier Set PRO 19-60 mm TT1
2/7	TTM116	Mini Pliers & Screwdriver Set TT1
2/7	TTX2032	Combination Spanner Set TTX4
2/7	TTZVG03	Power Grip Plier Set TTX2
3/7	TT3592	Combination Spanner Set AF TT1
3/7	TTAF32	1/4" & 3/8" Socket Set AF 6 pt TT1
3/7	TT1215AF	1/2" Socket Set 12 pt AF TT1
3/7	TTTX30	3/8" TX Bit Socket Set TT1
3/7	TTTD17	Tap and Die Set TT1
3/7	TT804	Puller Set TT1
3/7	TTX2640	Combination Spanner Set AF TTX4
3/7	TTZ01	Storage Tray TTX2 6 Compartments
4/7	TTPS09	General Tool Set BP TT4
4/7	TT917N	Screwdriver Set Mixed TT1
4/7	TT917TXN	Screwdriver Set TX & TPX TT1
4/7	TTX918N	Screwdriver Set Flat & PH TTX4
4/7	TTZ01	Storage Tray TTX2 6 Compartments

Drawer	Item ID	Description
5/7	TT9116N	1/2" Impact Socket Set ANSI TT1
5/7	TTHEX23	1/2" Hex Bit Socket Set TT1
5/7	TTTX23	1/2" TX Bit Socket Set TT1
5/7	TTMD74	Ratcheting Screwdriver Bit Set TT1
5/7	TTID20	1/2" Impact Driver Set TT1
5/7	TTALU	Clip Rail Set TT1
5/7	TTX2493	1/2" Torque Wrench & Breaker Bar Set TTX4
5/7	TTZ01	Storage Tray TTX2 6 Compartments
6/7	TTXMD4IN	Socket & Bit Set Flexible Handle TTX4
6/7	TTX6311	Double Ring Spanner Set TTX4
6/7	TTXPB3	Pry Bar Set Roll/Heel TTX4
6/7	TTNR81	Nutsert Gun Set TT1
6/7	TTPC09	Punch & Chisel Set TT1
6/7	TTZ01	Storage Tray TTX2 6 Compartments
7/7	EMPTY	



Item ID: **TKW37R663T**





**PRO35™**

**NEW**

**37" PRO35™ ROLLER CABINET TOOL KIT 595 PIECES RED**

**595**  
PIECES

**TT**  
SERIES

- 7** Drawer
- 3-Piece Cabinet Frame**
- Heavy Gauge Steel**
- 5-Step Phosphate-Free Rust Protection**
- 37" Wide Cabinet**
- 5" x 2" Castor Wheels with Brakes**
- 3 Step Ball Bearing Slides**
- Comfort Grip Handle**
- Combination Lock**





Drawer	Item ID	Description
	TSW37R7	37" PRO35™ roller cabinet 7 drawers red
	TC-TB03	Work Top for 37" Cabinet
	580T	Side shelf for roller cabinet 457 x 100 x 50mm
1/7	TT1435	1/4" Socket Set 6 pt TT1
1/7	TT3819	3/8" Socket Set 6 pt TT1
1/7	TT1205	1/2" Ratchet & Accessories Set TT1
1/7	TT1217-6	1/2" Socket Set 6 pt TT1
1/7	TTHEX23	1/2" Hex Bit Socket Set TT1
1/7	TTTX23	1/2" TX Bit Socket Set TT1
1/7	TTXEXT13	Extension Bars Set TTX4
1/7	TTZ01	Storage Tray TTX2 6 Compartments
2/7	TTHEX7	T-Handle Ball Point Hex Key Set TT1
2/7	TTTX7	T-Handle TX/TPX Key Set TT1
2/7	TT917N	Screwdriver Set Mixed TT1
2/7	TT917TXN	Screwdriver Set TX & TPX TT1
2/7	TTM116	Mini Pliers & Screwdriver Set TT1
2/7	TTMD74	Ratcheting Screwdriver Bit Set TT1
2/7	TTX918N	Screwdriver Set Flat & PH TTX4
2/7	TTZ01	Storage Tray TTX2 6 Compartments
3/7	TT1236	Combination Spanner Set TT1
3/7	TTADJ04	Adjustable Wrench Set TT1
3/7	TTVG05	Power Grip Plier Set TT1
3/7	TTPC09	Punsch & Chisel Set TT1
3/7	TTTX30	3/8" TX Bit Socket Set TT1
3/7	TTNR81	Nutsert Gun Set TT1
3/7	TTX6311	Double Ring Spanner Set TTX4
3/7	TTZ01	Storage Tray TTX2 6 Compartments
4/7	TT9116N	1/2" Impact Socket Set ANSI TT1
4/7	TT9212TX	1/2" TX Impact Socket Set DIN TT1
4/7	TT9015HX	3/8" & 1/2" Hex Impact Socket Set DIN TT1
4/7	TTID20	1/2" Impact Driver Set TT1
4/7	TT440Q	Plier Set Vinyl Grip Q TT1
4/7	TT474-7E	Circlip Plier Set PRO 19-60 mm TT1
4/7	TTX2493	1/2" Torque Wrench & Breaker Bar Set TTX4
4/7	TTZ01	Storage Tray TTX2 6 Compartments

Drawer	Item ID	Description
5/7	TTPS09	General Tool Set BP TT4
5/7	TT804	Puller Set TT1
5/7	TTTD17	Tap and Die Set TT1
5/7	TTXMDTN	Power Through Screwdriver Set TTX4
5/7	TTZ01	Storage Tray TTX2 6 Compartments
6/7	TTXPB3A	Pry Bar Set TTX4
6/7	TTXF05	Hand File Set TTX4
6/7	TTXPB3	Pry Bar Set Roll/Heel TTX4
6/7	HMEG800	Engineers Hammer 800g
6/7	HMDH70PU	Deadblow Hammer PU 70mm 1500g
6/7	HMS1250	Lump Hammer 1250g
6/7	TTZ01	Storage Tray TTX2 6 Compartments
7/7	TTX2032	Combination Spanner Set TTX4
7/7	TTX3402E	3/4" Ratchet & Accessories Set TTX4
7/7	TTX3414	3/4" Socket Set 6 pt TTX4
7/7	TTOS16	Oil Service Set TT1
7/7	TTSN11	Extractor & Nut Splitter Set TT1
SIDE SHELF	3401	3/4" Breaker Bar



Item ID: **TKW37R595T**





**PRO35™**

**26" PRO35™ ROLLER CABINET TOOL KIT 516 PIECES RED**

**516**  
PIECES

**TT**  
SERIES

- 7** Drawer
- 3-Piece Cabinet Frame**
- Heavy Gauge Steel**
- 5-Step Phosphate-Free Rust Protection**
- 26" Wide Cabinet**
- 5" x 1-1/4" Castor Wheels with Brakes**
- 3 Step Ball Bearing Slides**
- Comfort Grip Handle**
- Combination Lock**

**NEW**

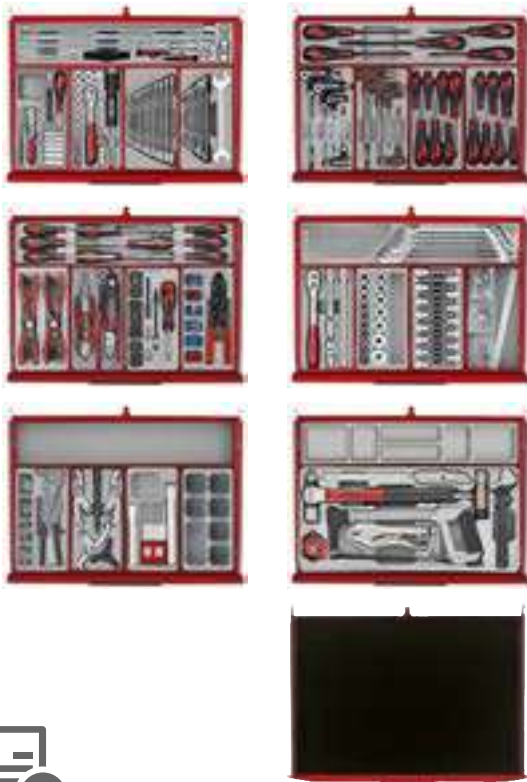

Drawer	Item ID	Description
	TSW26R7	26" PRO35™ roller cabinet 7 drawers red
	TCA08	Paper roll holder for side handle
1/7	TT1435	1/4" Socket Set 6 pt TT1
1/7	TT3819	3/8" Socket Set 6 pt TT1
1/7	TT1236	Combination Spanner Set TT1
1/7	TT6208	Double Open Ended Spanner Set TT1
1/7	TTXEXT13	Extension Bars Set TTX4
2/7	TTTX7	T-Handle TX/TPX Key Set TT1
2/7	TTHEX7	T-Handle Ball Point Hex Key Set TT1
2/7	TT917N	Screwdriver Set Mixed TT1
2/7	TT917TXN	Screwdriver Set TX & TPX TT1
2/7	TTXMDTN	Power Through Screwdriver Set TTX4
3/7	TT474-7E	Circlip Plier Set PRO 19-60 mm TT1
3/7	TT440Q	Plier Set Vinyl Grip Q TT1
3/7	TTMD74	Ratcheting Screwdriver Bit Set TT1
3/7	TTCP121	Crimping Plier Set TT1
3/7	TTXND	Nut Driver Set TTX4
4/7	TT1205	1/2" Ratchet & Accessories Set TT1
4/7	TT1217-6	1/2" Socket Set 6 pt TT1
4/7	TTTXH15	1/2" Long Hex & TX Bit Socket Set TT1
4/7	TTALU	Clip Rail Set TT1
4/7	TTX2032	Combination Spanner Set TTX4
5/7	TTHR81	Rivet Gun Set TT1
5/7	TT804	Puller Set TT1
5/7	TTPC09	Punch & Chisel Set TT1
5/7	TT01	Storage Tray TT1 7 Compartments
5/7	TTX00	Storage Tray TTX4 1 Compartment
6/7	TTPS09	General Tool Set BP TT4
6/7	TTX01	Storage Tray TTX4 6 Compartments
7/7	EMPTY	



Item ID: **TKW26R516T**







**PRO35™**

**628  
PIECES**

**TT  
SERIES**

**NEW**

**26" PRO35™ ROLLER CABINET TOOL KIT 628 PIECES RED**

- 7 Drawer**
- 3-Piece Cabinet Frame**
- Heavy Gauge Steel**
- 5-Step Phosphate-Free Rust Protection**
- 26" Wide Cabinet**
- 5" x 1-1/4" Castor Wheels with Brakes**
- 3 Step Ball Bearing Slides**
- Comfort Grip Handle**
- Combination Lock**



Drawer	Item ID	Description
	TSW26R7	26" PRO35™ roller cabinet 7 drawers red
	TCA08	Paper roll holder for side handle
1/7	TT143512	1/4" Socket Set 12 pt TT1
1/7	TT381912	3/8" Socket Set 12 pt TT1
1/7	TT1205	1/2" Ratchet & Accessories Set TT1
1/7	TT1217	1/2" Socket Set 12 pt TT1
1/7	TTXEXT13	Extension Bars Set TTX4
2/7	TT917N	Screwdriver Set Mixed TT1
2/7	TT917TXN	Screwdriver Set TX & TPX TT1
2/7	TTMD74	Ratcheting Screwdriver Bit Set TT1
2/7	TTHT28	Ball Point Hex & TX Key Set TT1
2/7	TTXMDTN	Power Through Screwdriver Set TTX4
3/7	TT1236	Combination Spanner Set TT1
3/7	TT6208	Double Open Ended Spanner Set TT1
3/7	TTHEX7	T-Handle Ball Point Hex Key Set TT1
3/7	TTTX7	T-Handle TX/TPX Key Set TT1
3/7	TTX2032	Combination Spanner Set TTX4
4/7	TT440Q	Plier Set Vinyl Grip Q TT1
4/7	TT474-7E	Circlip Plier Set PRO 19-60 mm TT1
4/7	TTCP121	Crimping Plier Set TT1
4/7	TTALU	Clip Rail Set TT1
4/7	TTX00	Storage Tray TTX4 1 Compartment
5/7	TT804	Puller Set TT1
5/7	TTPC09	Punch & Chisel Set TT1
5/7	TTTXH15	1/2" Long Hex & TX Bit Socket Set TT1
5/7	TT9116N	1/2" Impact Socket Set ANSI TT1
5/7	TTXND	Nut Driver Set TTX4
6/7	TTHR81	Rivet Gun Set TT1
6/7	TT1448	1/4" Socket & Bits Set TT1
6/7	TTNF12	Needle File Set TT1
6/7	TTSR04	Scraper Set TT1
6/7	TTX01	Storage Tray TTX4 6 Compartments
7/7	TTPS09	General Tool Set BP TT4
7/7	TTXF05	Hand File Set TTX4



Item ID: **TKW26R628T**





**PRO35™**

**NEW**

**26" PRO35™ TOOL CHEST TOOL KIT 137 PIECES RED**

**137**  
PIECES

**TT**  
SERIES

- 4** Drawer
- 3-Piece Cabinet Frame**
- Heavy Gauge Steel**
- 5-Step Phosphate-Free Rust Protection**
- 26" Wide Cabinet**
- 3 Step Ball Bearing Slides**
- Comfort Grip Handle**
- Combination Lock**



Drawer	Item ID	Description
	TST26R4	26" PRO35™ tool chest 4 drawers red
1/4	TT1435	1/4" Socket Set 6 pt TT1
1/4	TT3819	3/8" Socket Set 6 pt TT1
1/4	TT1205	1/2" Ratchet & Accessories Set TT1
1/4	TT1217-6	1/2" Socket Set 6 pt TT1
2/4	TT1236	Combination Spanner Set TT1
2/4	TT917N	Screwdriver Set Mixed TT1
2/4	TTHT28	Ball Point Hex & TX Key Set TT1
2/4	TT440Q	Plier Set Vinyl Grip Q TT1
3/4	TTPS09	General Tool Set BP TT4
4/4	EMPTY	



Item ID: **TKT26R137T**





# MECCA PRO™

## MECCA PRO TC-9 TT TOOL KIT 113 PIECES

113 PIECES
TT SERIES
Combination Lock



Section	Item ID	Description
1/3	TT1217	1/2" Socket Set 12 pt TT1 17 Pieces
1/3	TT1236	Combination Spanner Set TT1 12 Pieces
1/3	TT440-T	Plier Set TPR Grip TT1 4 Pieces
2/3	TT917N	Screwdriver Set Mixed TT1 7 Pieces
2/3	TT917TXN	Screwdriver Set TX & TPX TT1 7 Pieces
2/3	TTHEX7	T-Handle Ball Point Hex Key Set TT1 7 Pieces
3/3	TT1435	1/4" Socket Set 6 pt TT1 35 Pieces
3/3	TT3819	3/8" Socket Set 6 pt TT1 19 Pieces
3/3	TT1205	1/2" Ratchet & Accessories Set TT1 5 Pieces



Item ID: **SC01**

# MECCA PRO™

## MECCA PRO TC-9 TT TOOL KIT 232 PIECES

232 PIECES
TT SERIES
Combination Lock



Section	Item ID	Description
1/3	TT440	Plier Set Vinyl Grip TT1 4 Pieces
1/3	TTM116	Mini Pliers & Screwdriver Set TT1 16 Pieces
1/3	TTCP121	Crimping Plier Set TT1 121 Pieces
2/3	TTTM03	Inspection Set TT1 3 Pieces
2/3	TTNF12	Needle File Set TT1 12 Pieces
2/3	TTDB28	Drill Bit Set 1.0-13.0 mm TT2 28 Pieces
3/3	TT6508R	Ratcheting Spanner Set R TT1 8 Pieces
3/3	TTHT28	Ball Point Hex & TX Key Set TT1 28 Pieces
3/3	TTMD12D	Screwdriver Blade Set Mixed TT1 12 Pieces



Item ID: **SC02**





## MECCA PRO™

### MECCA PRO TC-9 TT TOOL KIT 193 PIECES

**293** PIECES  
**TT** SERIES  
**COMBINATION LOCK**



Section	Item ID	Description
1/3	TT440	Plier Set Vinyl Grip TTI 4 Pieces
1/3	TTM116	Mini Pliers & Screwdriver Set TTI 16 Pieces
1/3	TTMD12D	Screwdriver Blade Set Mixed TTI 12 Pieces
2/3	TT917N	Screwdriver Set Mixed TTI 7 Pieces
2/3	TT917TXN	Screwdriver Set TX & TPX TTI 7 Pieces
2/3	TTMD74	Ratcheting Screwdriver Bit Set TTI 74 Pieces
3/3	TT1435	1/4" Socket Set 6 pt TTI 35 Pieces
3/3	TTBS35	1/4" & 3/8" Bit Socket Set TTI 35 Pieces
3/3	TTTM03	Inspection Set TTI 3 Pieces



Item ID: **SC03**

## MECCA PRO™

### MECCA PRO TC-9 TT TOOL KIT 100 PIECES

**100** PIECES  
**TT** SERIES  
**COMBINATION LOCK**



Section	Item ID	Description
1/3	TT1236	Combination Spanner Set TTI 12 Pieces
1/3	TT917N	Screwdriver Set Mixed TTI 7 Pieces
1/3	TT440-T	Plier Set TPR Grip TTI 4 Pieces
2/3	SCPS01	General Tool Set BP TT3 6 Pieces
3/3	TT1435	1/4" Socket Set 6 pt TTI 35 Pieces
3/3	TT3819	3/8" Socket Set 6 pt TTI 19 Pieces
3/3	TT1218	1/2" Socket Set 12 pt TTI 17 Pieces



Item ID: **SC04**



# MECCA PRO™

## MECCA PRO TC-9 TT TOOL KIT E 100 PIECES

100  
PIECES

TT  
SERIES



Combination Lock



Section	Item ID	Description
1/3	TT1236	Combination Spanner Set TT1 12 Pieces
1/3	TT917N	Screwdriver Set Mixed TT1 7 Pieces
1/3	TT440-T	Plier Set TPR Grip TT1 4 Pieces
2/3	SCPS01E	General Tool Set E TT3 6 Pieces
3/3	TT1435	1/4" Socket Set 6 pt TT1 35 Pieces
3/3	TT3819	3/8" Socket Set 6 pt TT1 19 Pieces
3/3	TT1218	1/2" Socket Set 12 pt TT1 17 Pieces



Item ID: **SC04E**

# MECCA PRO™

## MECCA PRO TC-6T TT TOOL KIT 114 PIECES

114  
PIECES

TT  
SERIES



Section	Item ID	Description
1/2	TT440	Plier Set Vinyl Grip TT1 4 Pieces
1/2	TTHT28	Ball Point Hex & TX Key Set TT1 28 Pieces
1/2	TT01	Storage Tray TT1 7 Compartments
2/2	TT3819	3/8" Socket Set 6 pt TT1 19 Pieces
2/2	TT1236	Combination Spanner Set TT1 12 Pieces
2/2	TTMDQ49	Bits Driver Set TT1 49 Pieces



Item ID: **TC-6T01**





# MECCA PRO™

## MECCA PRO TC-6T TT MECHANICS TOOL KIT 37 PIECES

37  
PIECES

TT  
SERIES

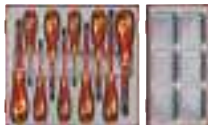

Section	Item ID	Description
1/2	TTV440	Insulated Plier Set TT1 4 Pieces
1/2	TTVSD09	Insulated Torque Screwdriver Blade Set TT1
1/2	TTV3814	Insulated Socket Set 3/8" Drive TT1
2/2	TTDV910N	Insulated Screwdriver Set Mixed TT2
2/2	TT04	Storage Tray TT1 6 Compartments



Item ID: **TC-6T02**





# TT SERIES TOOL TRAYS

## A FLEXIBLE TOOL CONTROL SYSTEM WITH OVER 240 TOOL SETS

The TT Series offers a space-saving tool control system allowing you to fit more tools in each drawer. With our wide assortment you can build some of the largest tool kits in the market, with over 1000 tools in a 26" wide stack. The tool trays are made of recyclable plastic that is easy to clean and they are ideal for use in dirty or high moisture environments.

### 1 CHOOSE YOUR STORAGE

Storages for all needs.



### 2 CHOOSE YOUR TOOL SETS

Your kit. Your way.



### 3 ORGANISE YOUR KIT

Optimise your workflow.

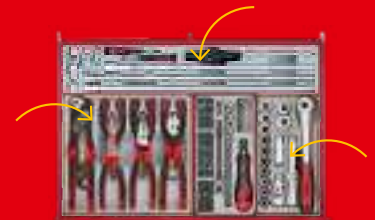

**TT**  
**SERIES**  
**SIZE**



Portable Service case



26" Top & Middle box drawer



26" cabinet drawer



37" cabinet drawer

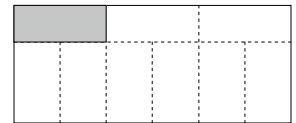
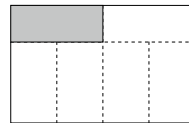
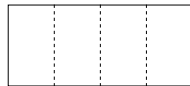
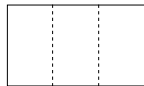
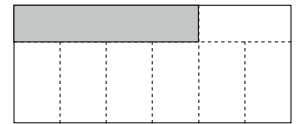
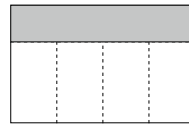
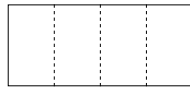
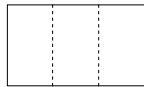
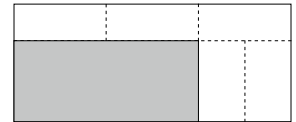
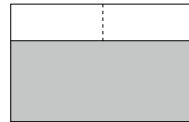
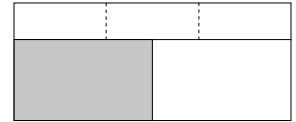
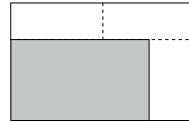
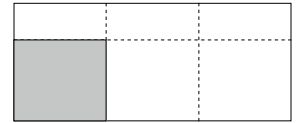
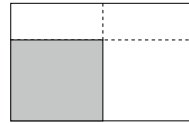
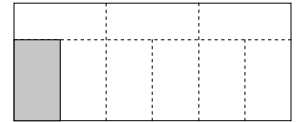
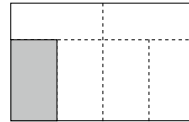
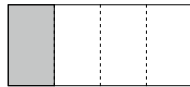
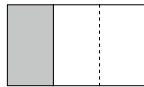





**BIT SET WITH BELT CLIP MIXED 29 PIECES**

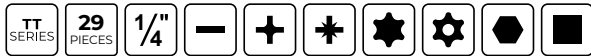

**CONTENTS**

- » 1/4" PH Bits 25mm  
PH1, PH2, PH3
- » 1/4" TPX Bits 25mm  
TPX20, TPX25, TPX30
- » 1/4" Hex Bits 25mm  
2, 3, 4, 5, 6, 8
- » 1/4" TX Bits 25mm  
TX10, TX15, TX20, TX25, TX30, TX40
- » 1/4" Magnetic Bit Holder 50mm
- » 1/4" ROB Bits 25mm  
1, 2, 3
- » 1/4" PZ Bits 25mm  
PZ1, PZ2, PZ3
- » 1/4" Flat Bits 25mm  
0.6 x 3.5, 1.0 x 5.5, 1.6 x 8.0
- » 1/4" Mini Bits Ratchet

Item ID: **TJ1429**



**IMPACT NUT SETTER SET WITH BELT CLIP 5 PIECES**

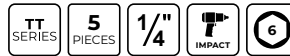

**CONTENTS**

- » 1/4" Impact Nut Setter
- » 1/4, 7, 8, 10, 13



**IMPACT BIT SET WITH BELT CLIP MIXED 29 PIECES**



**CONTENTS**

- » 1/4" PZ Impact Bits 30mm  
PZ1, PZ2 (x2), PZ3
- » 1/4" TX Impact Bits 30mm  
TX10, TX15, TX20 (x2), TX25 (x2), TX27, TX30 (x2), TX40
- » 1/4" PH G Impact Bits 30mm PH2G (x2)
- » 1/4" Hex Impact Bits 30mm  
3, 4 (x2), 5, 6
- » 1/4" PH Impact Bits 30mm  
PH1, PH2 (x2), PH3
- » 1/4" Magnetic Impact Bit Holder 60mm
- » 1/4" ROB Impact Bits 30mm  
1, 2
- » 1/4" Quick Chuck Impact Bit Holder 60mm

Item ID: **TJ1430**





**BIT SET WITH BELT CLIP MIXED 28 PIECES**

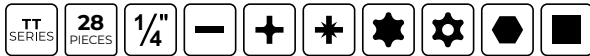

**CONTENTS**

- » 1/4" PH Bits 25mm  
PH1, PH2, PH3
- » 1/4" TPX Bits 25mm  
TPX20, TPX25, TPX30
- » 1/4" Quick Chuck Bit Holder 50mm
- » 1/4" Hex Bits 25mm  
4, 5, 6
- » 1/4" TX Bits 25mm  
TX10, TX15, TX20, TX25, TX30, TX40
- » 1/4" PH G Bits 25mm PH2G (x2)
- » 1/4" ROB Bits 25mm  
1, 2, 3
- » 1/4" Flat Bits 25mm  
0.6 x 4.5, 0.8 x 5.5, 1.2 x 6.5
- » 1/4" PZ Bits 25mm  
PZ1, PZ2, PZ3
- » Hex Socket Adaptor 1/4" Hex - 1/4" 25mm

Item ID: **TJ028**



**HOOK & PICK SET WITH BELT CLIP 4 PIECES**



Item ID: **TJ149**



**SCREW EXTRACTOR SET WITH BELT CLIP 5 PIECES**



**CONTENTS**

- » Screw Extractor  
1, 2, 3, 4, 5

Item ID: **TJSE055**





**1/4" SOCKET SET 6 PT WITH BELT CLIP 19 PIECES**



**CONTENTS**

- » 1/4" PH Bits 25mm  
PH1, PH2
- » 1/4" Socket 6 pt Metric  
8, 9, 10, 11, 12, 13
- » 1/4" Hex Bits 25mm  
4, 5, 6
- » 1/4" Magnetic Bit Holder 50mm
- » 1/4" Flat Bits 25mm  
0.6 x 4.5, 0.8 x 5.5, 1.2 x 6.5
- » 1/4" PZ Bits 25mm  
PZ1, PZ2
- » 1/4" Mini Bits Ratchet
- » Hex Socket Adaptor 1/4" Hex - 1/4" 25mm

Item ID: **TJ1419**



**1/4" SOCKET SET 6 PT WITH BELT CLIP 20 PIECES**



**CONTENTS**

- » 1/4" PH Bits 25mm  
PH1, PH2
- » 1/4" Socket 6 pt Metric  
5.5, 6, 7, 8, 9, 10, 13
- » 1/4" Magnetic Bit Holder 50mm
- » 1/4" TX Bits 25mm  
TX10, TX15, TX20
- » 1/4" Flat Bits 25mm  
0.6 x 4.5, 0.8 x 5.5, 1.2 x 6.5
- » 1/4" PZ Bits 25mm  
PZ1, PZ2
- » 1/4" Mini Bits Ratchet
- » Hex Socket Adaptor 1/4" Hex - 1/4" 25mm

Item ID: **TJ1420**





**1/4" SOCKET SET 6 PT WITH BELT CLIP 15 PIECES**



**CONTENTS**

- » 1/4" PH Bits 25mm  
PH1, PH2
- » 1/4" Socket 6 pt Metric  
5.5, 6, 7, 8, 10, 12, 13
- » 1/4" Extension Bar 50mm
- » 1/4" Flat Bits 25mm 0.8 x 5.5mm
- » 1/4" Hex Bits 25mm  
4, 5
- » 1/4" Bit Adaptor Hex Bit Coupler
- » 1/4" Mini Ratchet 72 Teeth

Item ID: **TJ1415**



**STORAGE TRAY FOR TJ SETS TTI**



Item ID: **TTTJ04**



**CLIP RAIL SET TTI 32 PIECES**



**CONTENTS**

- » Socket Clips 10 x 1/4"
- » Socket Clips 10 x 3/8"
- » Socket Clips 10 x 1/2"

Item ID: **TTALU**







STORAGE TRAY WITH TOOL HOLDER TTI



Item ID: TT00



STORAGE TRAY TTI 2 COMPARTMENTS



Item ID: TT02



STORAGE TRAY TTI 7 COMPARTMENTS



Item ID: TT01



STORAGE TRAY TTI 4 COMPARTMENTS



Item ID: TT03





STORAGE TRAY TTI 6 COMPARTMENTS



Item ID: **TT04**



STORAGE TRAY TT2 8 COMPARTMENTS



Item ID: **TTD01**



STORAGE TRAY TT2 4 COMPARTMENTS



Item ID: **TTD00**



STORAGE TRAY TT2 16 COMPARTMENTS



Item ID: **TTD02**





**STORAGE TRAY TTX4 1 COMPARTMENT**



Item ID: **TTX00**



**STORAGE TRAY TTX4 4 COMPARTMENTS**



Item ID: **TTX02**



**STORAGE TRAY TTX4 6 COMPARTMENTS**



Item ID: **TTX01**



**STORAGE TRAY TTX4 8 COMPARTMENTS**



Item ID: **TTX03**



**STORAGE TRAY TTX2 6 COMPARTMENTS**Item ID: **TTZ01****GENERAL TOOL SET E TT4 9 PIECES****CONTENTS**

- » Engineers Hammer 800g
- » Steel Rule mm/AF 200mm
- » Curved Jaw Power Grip Plier 235mm
- » Adjustable Wrench 250mm
- » Adjustable Wrench 150mm
- » Soft Face Hammer
- » Measuring Tape Metric/Inch 3m
- » Hacksaw 24TPI Metal
- » Utility Knife

Item ID: **TTPS09E****GENERAL TOOL SET BP TT4 9 PIECES****CONTENTS**

- » Ball Pein Hammer 24oz
- » Steel Rule mm/AF 200mm
- » Curved Jaw Power Grip Plier 235mm
- » Adjustable Wrench 250mm
- » Adjustable Wrench 150mm
- » Soft Face Hammer
- » Measuring Tape Metric/Inch 3m
- » Hacksaw 24TPI Metal
- » Utility Knife

Item ID: **TTPS09**





NEW



**GENERAL TOOL SET BP TT3 6 PIECES**

TT SERIES **3** 6 PIECES

CONTENTS

- » Quick Action Utility Knife
- » Curved Jaw Power Grip Plier 235mm
- » Measuring Tape Metric/Inch 3m
- » Adjustable Wrench 200mm
- » Hacksaw 24TPI Metal
- » Ball Pein Hammer 16oz

Item ID: **SCPS01**



**GENERAL TOOL SET E TT3 6 PIECES**

TT SERIES **3** 6 PIECES

CONTENTS

- » Engineers Hammer 500g
- » Quick Action Utility Knife
- » Curved Jaw Power Grip Plier 235mm
- » Measuring Tape Metric/Inch 3m
- » Adjustable Wrench 200mm
- » Hacksaw 24TPI Metal

Item ID: **SCPS01E**



**LONG ARM RATCHET SET TTX4 3 PIECES**

TT SERIES **3** PIECES **1/4** **3/8** **1/2**

CONTENTS

- » 1/4" Ratchet Long Arm 43 Teeth 200mm
- » 3/8" Ratchet Long Arm 41 Teeth 300mm
- » 1/2" Ratchet Long Arm 45 Teeth 400mm

Item ID: **TTXRL03**

NEW



**FLEX HANDLE SET TTX4 3 PIECES**

TT SERIES **3** PIECES **1/4** **3/8** **1/2**

CONTENTS

- » 1/4" Flex Handle 200 mm
- » 3/8" Flex Handle 300 mm
- » 1/2" Flex Handle 400 mm

Item ID: **TTXBR03**



**NEW****LONG ARM RATCHET FLEX HEAD SET TTX4 3 PIECES****CONTENTS**

- » 1/4" Long Ratchet Flexible Head 43 Teeth 200mm
- » 3/8" Long Ratchet Flexible Head 41 Teeth 300mm
- » 1/2" Long Ratchet Flexible Head 45 Teeth 400mm

Item ID: **TTXRF03****1/4" SOCKET SET 6 PT TTI 35 PIECES****CONTENTS**

- » 1/4" PH Bits 25mm  
PH1, PH2
- » 1/4" Ratchet 72 Teeth
- » 1/4" Socket 6 pt Metric  
4, 5, 5.5, 6, 7, 8, 9, 10, 11, 12, 13
- » Reducing Adaptor 3/8"F - 1/4"M
- » 1/4" Extension Bar 50mm
- » 1/4" Extension Bar 100mm
- » 1/4" Hex Bits 25mm  
5, 6
- » 1/4" Deep Socket 6 pt Metric  
6, 7, 8, 10, 12, 13
- » 1/4" TPX Bits 25mm  
TPX10, TPX15, TPX20
- » 1/4" Flat Bits 25mm  
0.8 x 4.0, 0.8 x 5.5
- » 1/4" PZ Bits 25mm  
PZ1, PZ2
- » 1/4" Universal Joint
- » 1/4" Spinner Handle
- » 1/4" Bit Adaptor Hex Bit Coupler

Item ID: **TTI435**



**1/4" SOCKET SET 12 PT TTI 35 PIECES**



**CONTENTS**

- » 1/4" PH Bits 25mm  
PH1, PH2
- » 1/4" Ratchet 72 Teeth
- » Reducing Adaptor 3/8"F - 1/4"M
- » 1/4" Extension Bar 50mm
- » 1/4" Extension Bar 100mm
- » 1/4" Hex Bits 25mm  
5, 6
- » 1/4" Socket 12 pt Metric  
4, 5, 5.5, 6, 7, 8, 9, 10, 11, 12, 13
- » 1/4" Deep Socket 12 pt Metric  
6, 7, 8, 10, 12, 13
- » 1/4" TPX Bits 25mm  
TPX10, TPX15, TPX20
- » 1/4" Flat Bits 25mm  
0.8 x 4.0, 0.8 x 5.5
- » 1/4" PZ Bits 25mm  
PZ1, PZ2
- » 1/4" Universal Joint
- » 1/4" Spinner Handle
- » 1/4" Bit Adaptor Hex Bit Coupler

Item ID: **TT143512**



**1/4" & 3/8" SOCKET SET AF 6 PT TTI 32 PIECES**

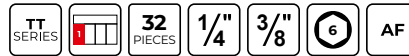

**CONTENTS**

- » 1/4" Socket 6 pt AF  
3/16, 7/32, 1/4, 9/32, 5/16, 11/32, 3/8, 7/16, 1/2
- » 1/4" Deep Socket 6 pt AF  
3/16, 7/32, 1/4, 9/32, 5/16, 11/32, 3/8, 7/16, 1/2
- » 3/8" Socket 6 pt AF  
3/8, 7/16, 1/2, 9/16, 5/8, 11/16, 3/4
- » 3/8" Deep Socket 6 pt AF  
3/8, 7/16, 1/2, 9/16, 5/8, 11/16, 3/4

Item ID: **TTAF32**

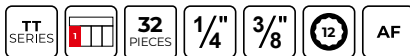

**1/4" & 3/8" SOCKET SET 12 PT AF TTI 32 PIECES****CONTENTS**

- » 1/4" Socket 12 pt AF
  - » 3/16, 7/32, 1/4, 9/32, 5/16, 11/32, 3/8, 7/16, 1/2
- » 1/4" Deep Socket 12 pt AF
  - » 3/16, 7/32, 1/4, 9/32, 5/16, 11/32, 3/8, 7/16, 1/2
- » 3/8" Socket 12 pt AF
  - » 3/8, 7/16, 1/2, 9/16, 5/8, 11/16, 3/4
- » 3/8" Deep Socket 12 pt AF
  - » 3/8, 7/16, 1/2, 9/16, 5/8, 11/16, 3/4

Item ID: **TTAF3212****1/4" SOCKET & BITS SET TTI 48 PIECES****CONTENTS**

- » 1/4" PH Bits 25mm
  - » PH1, PH2, PH3
- » 1/4" Socket 6 pt Metric
  - » 5, 5.5, 6, 7, 8, 9, 10, 11, 12, 13
- » 1/4" PH Bits 89mm
  - » PH1, PH2
- » 1/4" TPX Bits 25mm
  - » TPX20, TPX25, TPX30
- » 1/4" Flat Bits 89mm
  - » 0.5 x 3.0, 0.8 x 4.0
- » 1/4" Hex Bits 25mm
  - » 2, 3, 4, 5, 6, 8
- » 1/4" TX Bits 89mm
  - » TX10, TX20, TX25
- » 1/4" TX Bits 25mm
  - » TX10, TX15, TX20, TX25, TX30, TX40
- » 1/4" Gearless Palm Ratchet
- » 1/4" PZ Bits 89mm
  - » PZ1, PZ2
- » 1/4" ROB Bits 25mm
  - » 1, 2, 3
- » 1/4" PZ Bits 25mm
  - » PZ1, PZ2, PZ3
- » 1/4" Flat Bits 25mm
  - » 0.6 x 3.5, 1.0 x 5.5, 1.6 x 8.0
- » 1/4" Extension Bar 75mm

Item ID: **TT1448**



**3/8" SOCKET SET 6 PT TTI 19 PIECES**



**CONTENTS**

- » Reducing Adaptor 1/2"F - 3/8"M
- » 3/8" Socket 6 pt Metric
  - » 8, 9, 10, 11, 12, 13, 14, 15, 16, 17, 18, 19, 22
- » 3/8" Wobble Extension Bar 75mm
- » 3/8" Rotating Spinner Handle
- » 3/8" Bit Adaptor Hex bit coupler 1/4" Hex
- » 3/8" Universal Joint
- » 3/8" Ratchet 72 Teeth

Item ID: **TT3819**



**3/8" SOCKET SET 12 PT TTI 19 PIECES**



**CONTENTS**

- » Reducing Adaptor 1/2"F - 3/8"M
- » 3/8" Wobble Extension Bar 75mm
- » 3/8" Socket 12 pt Metric
  - » 8, 9, 10, 11, 12, 13, 14, 15, 16, 17, 18, 19, 22
- » 3/8" Rotating Spinner Handle
- » 3/8" Bit Adaptor Hex bit coupler 1/4" Hex
- » 3/8" Universal Joint
- » 3/8" Ratchet 72 Teeth

Item ID: **TT381912**



**3/8" SOCKET SET 6 PT TTI 16 PIECES**



**CONTENTS**

- » 3/8" Deep Socket 6 pt Metric
  - » 7, 8, 9, 10, 11, 12, 13, 14, 15, 16, 17, 18, 19, 20, 21, 22

Item ID: **TT3816**



**3/8" SOCKET SET 12 PT TTI 16 PIECES**



**CONTENTS**

- » 3/8" Deep Socket 12 pt Metric
  - » 7, 8, 9, 10, 11, 12, 13, 14, 15, 16, 17, 18, 19, 20, 21, 22

Item ID: **TT381612**





**3/8" TX BIT SOCKET SET TTI 30 PIECES****CONTENTS**

- » Reducing Adaptor 3/8"F - 1/4"M
- » 3/8" TX Bit Socket
  - » TX10, TX15, TX20, TX25, TX27, TX30, TX40, TX45, TX50
- » 1/4" TX-E Socket
  - » E4, E5, E6, E7, E8
- » 3/8" TPX Bit Socket
  - » TPX10, TPX15, TPX20, TPX25, TPX27, TPX30, TPX40, TPX45, TPX50
- » 3/8" TX-E Socket
  - » E10, E12, E14, E16, E18
- » 3/8" Extension Bar 75mm

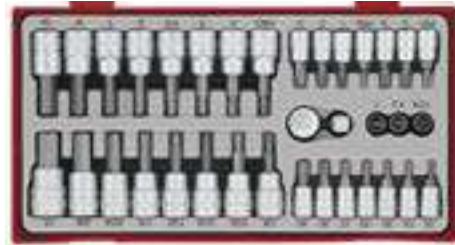
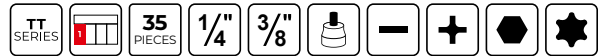
Item ID: **TTTX30****1/4" & 3/8" BIT SOCKET SET TTI 35 PIECES****CONTENTS**

- » 1/4" TX Bit Socket
  - » TX10, TX15, TX20, TX25, TX27, TX30, TX40
- » 1/4" PH Bit Socket
  - » PH0, PH1, PH2, PH3
- » Reducing Adaptor 3/8"F - 1/4"M
- » Step Up Adaptor 1/4"F - 3/8"M
- » 3/8" Hex Bit Socket AF
  - » 1/4, 1/8, 3/16, 3/8, 5/16, 5/32, 7/32
- » 3/8" Hex Bit Socket Metric
  - » 3, 4, 5, 5.5, 6, 7, 8, 10, 12
- » 1/4" PZ Bit Socket
  - » PZ1, PZ2, PZ3
- » 1/4" Flat Bit Socket
  - » 4, 4.5, 7

Item ID: **TTBS35**



**1/2" RATCHET & ACCESSORIES SET TTI 5 PIECES**



**CONTENTS**

- » 1/2" Universal Joint
- » 1/2" Ratchet 72 Teeth
- » 1/2" Extension Bar 255mm
- » 1/2" Extension Bar 125mm
- » Step Up Adaptor 3/8" F - 1/2" M

Item ID: **TT1205**



**1/2" SOCKET SET 12 PT TTI 17 PIECES**



**CONTENTS**

- » 1/2" Socket 12 pt Metric
- » 10, 11, 12, 13, 14, 15, 16, 17, 18, 19, 20, 21, 22, 24, 27, 30, 32

Item ID: **TT1217**



**1/2" SOCKET SET 12 PT TTI 11 PIECES**



**CONTENTS**

- » 1/2" Deep Socket 12 pt Metric
- » 10, 11, 12, 13, 14, 15, 16, 17, 18, 19
- » 1/2" Flex Handle 265mm

Item ID: **TT1211**



**1/2" SOCKET SET 6 PT TTI 17 PIECES**



**CONTENTS**

- » 1/2" Socket 6 pt Metric
- » 10, 11, 12, 13, 14, 15, 16, 17, 18, 19, 20, 21, 22, 24, 27, 30, 32

Item ID: **TT1217-6**



**1/2" SOCKET SET 12 PT TTI 17 PIECES****CONTENTS**

- » 1/2" Socket 12 pt Metric
- » 10, 11, 12, 13, 14, 15, 16, 17, 18, 19, 22, 24
- » 1/2" Universal Joint
- » 1/2" Ratchet 72 Teeth
- » Step Up Adaptor 3/8"F - 1/2"M
- » 1/2" Extension Bar 63.5mm
- » 1/2" Extension Bar 150mm

Item ID: **TT1218****1/2" SOCKET SET 6 PT TTI 18 PIECES****CONTENTS**

- » 1/2" Socket 6 pt Metric
- » 10, 11, 12, 13, 14, 15, 16, 17, 18, 19, 22, 24
- » 1/2" Universal Joint
- » 1/2" Ratchet 72 Teeth
- » Step Up Adaptor 3/8"F - 1/2"M
- » 1/2" Extension Bar 63.5mm
- » 1/2" Extension Bar 150mm

Item ID: **TT1218-6****1/2" SOCKET SET 12 PT AF TTI 15 PIECES****CONTENTS**

- » 1/2" Socket 12 pt AF
- » 3/8, 7/16, 1/2, 9/16, 5/8, 11/16, 3/4, 13/16, 7/8, 15/16, 1, 1-1/16, 1-1/8, 1-3/16, 1-1/4

Item ID: **TT1215AF****1/2" HEX BIT SOCKET SET TTI 16 PIECES****CONTENTS**

- » 1/2" Long Hex Bit Socket Metric
- » 5, 6, 10, 12, 14, 17
- » 1/2" Hex Bit Socket Metric
- » 5, 6, 7, 8, 9, 10, 12, 14, 17
- » 1/2" Extra Long Hex Bit Socket Metric 8mm

Item ID: **TTHex16**



**1/2" HEX BIT SOCKET SET TTI 23 PIECES**



**CONTENTS**

- » Hex Bits 40mm
- » 5, 6, 7, 8, 9, 10, 12, 14, 17, 19
- » Hex Mini Screwdriver 2
- » Hex Bits 75mm
- » 5, 6, 7, 8, 9, 10, 12, 14, 17, 19
- » 1/2" Bit Adaptor 12mm
- » 1/2" Bit Adaptor 10mm

Item ID: **TTHEX23**



**1/2" TX BIT SOCKET SET TTI 23 PIECES**



**CONTENTS**

- » TX Bits 40mm
- » TX20, TX25, TX27, TX30, TX40, TX45, TX50, TX55, TX60, TX70
- » TX Bits 75mm
- » TX20, TX25, TX27, TX30, TX40, TX45, TX50, TX55, TX60, TX70
- » 1/2" Bit Adaptor 10mm
- » 1/2" Bit Adaptor 12mm
- » Hex Mini Screwdriver 2

Item ID: **TTTX23**



**1/2" TX BIT SOCKET SET TTI 18 PIECES**



**CONTENTS**

- » 1/2" Long TX Bit Socket
- » TX20, TX25, TX27, TX30, TX40, TX45, TX50, TX55, TX60
- » 1/2" TX Bit Socket
- » TX20, TX25, TX27, TX30, TX40, TX45, TX50, TX55, TX60

Item ID: **TTTX18**

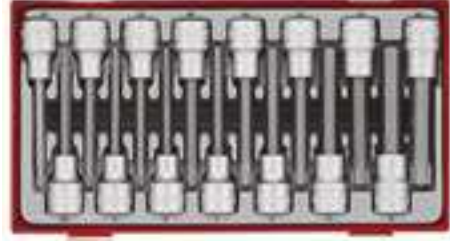

**1/2" LONG HEX & TX BIT SOCKET SET TTI 15 PIECES**

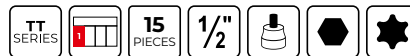

**CONTENTS**

- » 1/2" Long TX Bit Socket
- » TX20, TX25, TX27, TX30, TX40, TX45, TX50, TX55, TX60
- » 1/2" Long Hex Bit Socket Metric
- » 5, 6, 7, 8, 10, 12

Item ID: **TTTXH15**



**1/2" LONG RIBE® & XZN/TRIPLE SQUARE BIT SOCKET SET  
TT1 15 PIECES****CONTENTS**

- » 1/2" Long Ribe® Bit Socket
- » 4, 5, 6, 8, 10, 11, 12, 13
- » 1/2" Long XZN/Triple Square Bit Socket
- » 5, 6, 8, 10, 12, 14, 16

Item ID: **TTRS15****EXTENSION BARS SET TTX4 13 PIECES****CONTENTS**

- » Reducing Adaptor 3/8"F - 1/4"M
- » Hex Mini Screwdriver
- » 2, 2.5
- » 1/2" Universal Joint
- » 1/4" Universal Joint
- » 3/8" Universal Joint
- » 3/8" Wobble Extension Bar 75mm
- » 1/2" Extension Bar 500mm
- » 1/4" Extension Bar 150mm
- » 1/4" Extension Bar 305mm
- » T Bar Handle Grip
- » 3/8" Extension Bar 500mm
- » 1/2" Wobble Extension Bar 75mm

Item ID: **TTXEXT13**





**3/4" RATCHET & ACCESSORIES SET TTX4 4 PIECES**

TT SERIES 4 PIECES 3/4"

**CONTENTS**

- » 3/4" Extension Bar 400mm
- » 3/4" Extension Bar 200mm
- » 3/4" Sliding T Bar
- » 3/4" Ratchet Heavy Duty 72 Teeth

Item ID: **TTX3404**



**3/4" RATCHET & ACCESSORIES SET TTX4 2 PIECES**

TT SERIES 2 PIECES 3/4"

**CONTENTS**

- » 3/4" Extension Bar 400mm
- » 3/4" Extendable Ratchet 72 Teeth 545-860mm

Item ID: **TTX3402E**



**3/4" RATCHET & ACCESSORIES SET SAFETY LOCK TTX4 4 PIECES**

TT SERIES 4 PIECES 3/4"

**CONTENTS**

- » 3/4" Extension Bar Safety Lock 400mm
- » 3/4" Extension Bar Safety Lock 200mm
- » 3/4" Sliding T Bar Safety Lock
- » 3/4" Ratchet Heavy Duty 72 Teeth

Item ID: **TTX3404S**



**3/4" SOCKET SET 6 PT TTX4 14 PIECES**

TT SERIES 14 PIECES 3/4" mm

**CONTENTS**

- » 3/4" Socket 6 pt Metric
- » 19, 21, 22, 24, 27, 30, 32, 33, 34, 36, 38, 41, 46, 50

Item ID: **TTX3414**



**3/4" SOCKET SET 12 PT AF TTX4 14 PIECES****CONTENTS**

- » 3/4" Socket 12 pt AF
- » 7/8, 15/16, 1, 1-1/16, 1-1/8, 1-3/16, 1-1/4, 1-5/16, 1-3/8, 1-7/16, 1-1/2, 1-5/8, 1-3/4, 1-7/8

Item ID: **TTX34AF****SOCKET ADAPTOR SET TTI 17 PIECES****CONTENTS**

- » 1/4" Bit Adaptor for 1/2" Sockets
- » 1/4" Bit Adaptor for 1/4" Sockets
- » 1/4" Bit Adaptor for 3/8" Sockets
- » Reducing Adaptor 3/8"F - 1/4"M
- » Reducing Adaptor 1/2"F - 3/8"M
- » Reducing Adaptor 3/4"F - 1/2"M
- » 1/4" Quick Chuck Bit Holder 50mm
- » Step Up Adaptor 1/4"F - 3/8"M
- » Step Up Adaptor 3/4"F - 1"M
- » Step Up Adaptor 1/2"F - 3/4"M
- » Step Up Adaptor 3/8"F - 1/2"M
- » 1/4" Magnetic Bit Holder 50mm
- » 1/4" Magnetic Bit Holder 70mm
- » 3/8" Bit Adaptor Hex bit coupler 1/4" Hex
- » 1/4" Bit Adaptor Hex Bit Coupler
- » Hex Socket Adaptor 1/4" Hex - 3/8" 32mm
- » Hex Socket Adaptor 1/4" Hex - 1/4" 25mm

Item ID: **TTADP17**



**1/4" & 3/8" IMPACT SOCKET SET ANSI TTI 24 PIECES**

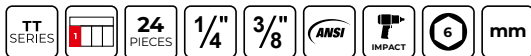

**CONTENTS**

- » 1/4" Impact Socket ANSI Metric  
6, 7, 8, 10, 13
- » 3/8" Deep Impact Socket ANSI Metric  
8, 10, 11, 12, 13, 14, 16, 17, 19
- » 3/8" Impact Socket ANSI Metric  
8, 10, 11, 12, 13, 14, 16, 17, 19
- » Impact Reducing Adaptor 3/8"F - 1/4"M DIN

Item ID: **TT9024**



**1/2" IMPACT SOCKET ACCESSORIES SET DIN TTI 11 PIECES**



**CONTENTS**

- » Impact Step Up Adaptor 3/8"F (DIN) - 1/2"M (DIN)
- » Impact Step Up Adaptor 1/2"F (DIN) - 3/4"M (DIN)
- » 1/2" Impact Extension Bar (DIN) 75mm
- » 1/2" Impact Extension Bar (DIN) 250mm
- » 1/2" Impact Extension Bar (DIN) 125mm
- » Retaining Ring  
19 x 4, 24 x 4
- » Retaining Pin  
3 x 20, 3 x 25
- » 1/2" Impact Universal Joint DIN
- » Impact Reducing Adaptor 1/2"F (DIN) - 3/8"M (ANSI)

Item ID: **TT9207**





**1/2" IMPACT SOCKET ACCESSORIES SET ANSI TTI 11 PIECES**



**CONTENTS**

- » Impact Step Up Adaptor 1/2"F (DIN) - 3/4"M (ANSI)
- » Impact Step Up Adaptor 3/8"F (DIN) - 1/2"M (ANSI)
- » Retaining Ring
  - » 19 x 4, 24 x 4
- » Retaining Pin
  - » 3 x 20, 3 x 25
- » 1/2" Impact Universal Joint ANSI
- » 1/2" Impact Extension Bar (ANSI) 75mm
- » 1/2" Impact Extension Bar (ANSI) 125mm
- » 1/2" Impact Extension Bar (ANSI) 250mm
- » Impact Reducing Adaptor 1/2"F (DIN) - 3/8"M (ANSI)

Item ID: **TT9207A**



**1/2" IMPACT SOCKET SET ANSI TTI 16 PIECES**

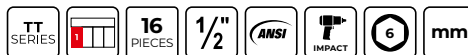

**CONTENTS**

- » 1/2" Impact Socket ANSI Metric
  - » 13, 15, 16, 17, 18, 19, 22, 24
- » 1/2" Deep Impact Socket ANSI Metric
  - » 13, 15, 16, 17, 18, 19, 22, 24

Item ID: **TT9116N**



**1/2" IMPACT SOCKET SET DIN TTI 12 PIECES**

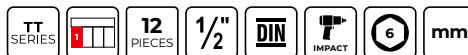

**CONTENTS**

- » 1/2" Deep Impact Socket DIN Metric
  - » 19, 21, 22, 24, 27
- » 1/2" Impact Socket DIN Metric
  - » 19, 21, 22, 24, 27, 30, 32
- » Retaining Ring 24 x 4.0mm
- » Retaining Pin 3 x 25mm

Item ID: **TT9212**





**1/2" IMPACT SOCKET SET DIN TTI 20 PIECES**

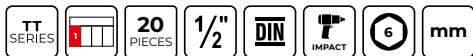

**CONTENTS**

- » 1/2" Deep Impact Socket DIN Metric  
13, 15, 16, 17, 18, 19, 22, 24
- » 1/2" Impact Socket DIN Metric  
13, 15, 16, 17, 18, 19, 22, 24
- » Retaining Ring  
19 x 4, 24 x 4
- » Retaining Pin  
3 x 20, 3 x 25

Item ID: **TT9120DN**



**1/2" TX IMPACT SOCKET SET DIN TTI 12 PIECES**

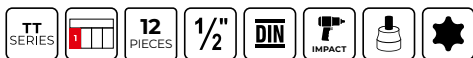

**CONTENTS**

- » 1/2" TX Impact Socket DIN  
TX10, TX15, TX20, TX25, TX27, TX30, TX40, TX45,  
TX50, TX55, TX60, TX70

Item ID: **TT9212TX**



**1/2" TORQUE STICKS & WHEEL NUT SET TTI 8 PIECES**



**CONTENTS**

- » Impact Step Up Adaptor 3/8" F - 1/2" M DIN
- » 1/2" Impact Socket Wheel Nut  
17, 19, 21
- » 1/2" Torque Stick 90Nm
- » 1/2" Torque Stick 110Nm
- » 1/2" Torque Stick 120Nm
- » 1/2" Torque Stick 140Nm

Item ID: **TTTS08**



**3/8" & 1/2" HEX IMPACT SOCKET SET DIN TTI 15 PIECES**

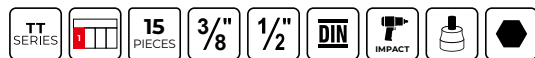

**CONTENTS**

- » 3/8" Hex Bit Impact Socket DIN Metric  
4, 5, 6, 7, 8, 10, 12
- » 1/2" Hex Impact Socket DIN Metric  
5, 6, 8, 10, 12, 14, 17, 19

Item ID: **TT9015HX**





**3/4" IMPACT SOCKET SET DIN TT2 12 PIECES****CONTENTS**

- » 3/4" Impact Socket DIN Metric  
19, 24, 27, 30, 32, 33, 34, 36, 38
- » Retaining Ring 36 x 5.0mm (x3)
- » Retaining Pin 4 x 35mm (x3)

Item ID: **TTD9416****1/2" IMPACT DRIVER SET TTI 20 PIECES****CONTENTS**

- » 1/2" Impact Driver Heavy Duty
- » 5/16" Flat Impact Driver Bits  
6, 8, 10, 12
- » 5/16" PH Impact Driver Bits  
PH1, PH2, PH3, PH4
- » 5/16" Hex Impact Driver Bits  
4, 5, 6, 8
- » 5/16" TX Impact Driver Bits  
TX30, TX40, TX45, TX50, TX55
- » 1/2" Impact Coupler Adaptor 5/16" Hex
- » Hex Socket Adaptor 5/16" Hex - 3/8"

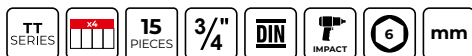
Item ID: **TTID20****3/4" IMPACT SOCKET SET DIN TTX4 15 PIECES****CONTENTS**

- » 3/4" Deep Impact Socket DIN Metric  
19, 24, 27, 30, 32, 33, 36
- » 3/4" Impact Socket DIN Metric  
19, 24, 27, 28, 30, 32, 34, 36

Item ID: **TTX9415**



**1/4" IMPACT DRIVER SET TTI 19 PIECES**



**CONTENTS**

- » 1/4" Impact Driver
- » 1/4" Impact Socket ANSI Metric  
8, 10, 13
- » 1/4" Screw Extractor  
1, 2, 3
- » 1/4" PZ Impact Bits 50mm  
PZ2, PZ3
- » 1/4" PH Impact Bits 50mm  
PH2, PH3
- » 1/4" Hex Impact Bits 50mm  
3, 4, 5, 6
- » 1/4" Impact Bit Adaptor 1/4" Hex
- » 1/4" TX Impact Bits 50mm  
TX25, TX30, TX40

Item ID: **TTID19**



**TORQUE SCREWDRIVER SET TTI 38 PIECES**

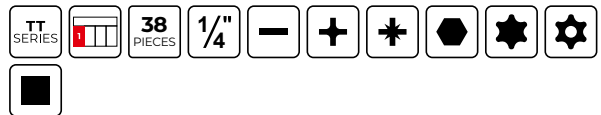

**CONTENTS**

- » Hex Socket Adaptor 1/4" Hex - 1/4" 30mm
- » 1/4" TX Bits 25mm  
TX8, TX9, TX10, TX15, TX20, TX25, TX27, TX30, TX40
- » 1/4" PH Bits 25mm  
PH0, PH1, PH2, PH3
- » 1/4" TPX Bits 25mm  
TPX10, TPX15, TPX20, TPX30, TPX40
- » 1/4" Hex Bits 25mm  
2, 3, 4, 5, 6
- » 1/4" PH G Bits 25mm PH2G
- » 1/4" Torque Screwdriver 1-5Nm
- » 1/4" ROB Bits 25mm  
1, 2, 3
- » 1/4" Flat Bits 25mm  
0.5 x 3.0, 0.6 x 4.5, 0.8 x 5.5, 1.2 x 6.5
- » 1/4" PZ Bits 25mm  
PZ0, PZ1, PZ2, PZ3

Item ID: **TTSD38**



**3/8" TORQUE WRENCH SET 20-110 NM TTX4 22 PIECES****CONTENTS**

- » 3/8" Extension Bar 125mm
- » 3/8" Extension Bar 75mm
- » 3/8" Crow Foot Wrench
- » 10, 11, 12, 13, 14, 15, 16, 17, 18, 19
- » TX Bits 40mm
- » TX8, TX10, TX15, TX20, TX25, TX27, TX30, TX40
- » 3/8" Torque Wrench 20 - 110Nm
- » 3/8" Bit Adaptor Hex bit coupler 10mm Hex

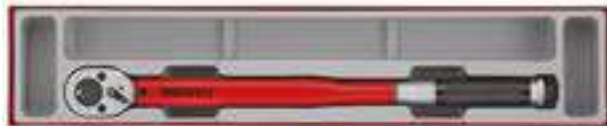
Item ID: **TTX3892****1/2" TORQUE WRENCH 40-210 NM TTX4****CONTENTS**

- » 1/2" Torque Wrench 40 - 210Nm

Item ID: **TTX1292**



**NEW**



**1/2" TORQUE WRENCH & BREAKER BAR SET TTX4**



**CONTENTS**

- » 1/2" Torque Wrench 40 - 210Nm
- » 1/2" Breaker Bar 450 mm DIN3122

Item ID: **TTX2493**

**1/2" TORQUE MULTIPLIER SET TTX4 2 PIECES**



**CONTENTS**

- » Torque Multiplier 1:3 1/2"F - 3/4"M
- » 1/2" Torque Wrench 40 - 210Nm

Item ID: **TTXMP12**



**1/2" TORQUE WRENCH P-SERIES 40-200 NM TTX4**



**CONTENTS**

- » 1/2" Torque Wrench Plus 40 - 200Nm

Item ID: **TTXP1292**

**COMBINATION SPANNER SET ANTI SLIP TTI 12 PIECES**



**CONTENTS**

- » Combination Spanner Anti Slip Metric
- » 8, 9, 10, 11, 12, 13, 14, 15, 16, 17, 18, 19

Item ID: **TT8012**





**STUBBY COMBINATION SPANNER SET TT1 10 PIECES**



**CONTENTS**

- » Stubby Combination Spanner Metric
- » 10, 11, 12, 13, 14, 15, 16, 17, 18, 19

Item ID: **TT6010M**



**COMBINATION SPANNER SET AF TT1 8 PIECES**



**CONTENTS**

- » Combination Spanner AF
- » 5/16", 3/8", 7/16", 1/2", 9/16", 5/8", 11/16", 3/4"

Item ID: **TT3592**



**COMBINATION SPANNER SET TT1 12 PIECES**



**CONTENTS**

- » Combination Spanner Metric
- » 8, 9, 10, 11, 12, 13, 14, 15, 16, 17, 18, 19

Item ID: **TT1236**



**COMBINATION SPANNER SET TTX4 7 PIECES**



**CONTENTS**

- » Combination Spanner Metric
- » 20, 21, 22, 24, 27, 30, 32

Item ID: **TTX2032**







**COMBINATION SPANNER SET AF TTX4 7 PIECES**



**CONTENTS**

- » Combination Spanner AF
- » 13/16", 7/8", 15/16", 1", 1-1/16", 1-1/8", 1-1/4"

Item ID: **TTX2640**



**LONG COMBINATION SPANNER SET TTX4 12 PIECES**



**CONTENTS**

- » Long Combination Spanner Metric
- » 8, 9, 10, 11, 12, 13, 14, 15, 16, 17, 18, 19

Item ID: **TTXLMP12**



**NEW**

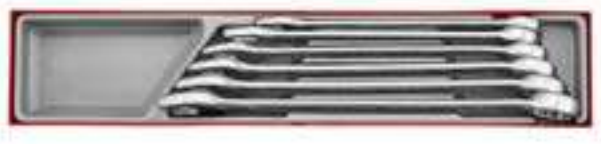

**COMBINATION SPANNER SET TTX4 6 PIECES**



**CONTENTS**

- » Combination Spanner Metric
- » 24, 27, 30, 32, 34, 36

Item ID: **TTX2436**



**RATCHETING COMBINATION SPANNER SET R TT1 8 PIECES**



**CONTENTS**

- » Ratcheting Combination Spanner Metric R
- » 8, 10, 11, 12, 13, 14, 17, 19

Item ID: **TT6508R**



**RATCHETING COMBINATION SPANNER SET R TT1 11 PIECES****CONTENTS**

- » Ratcheting Combination Spanner Metric R
- » 8, 10, 11, 12, 13, 14, 15, 16, 17, 18, 19

Item ID: **TT6511R****RATCHETING COMBINATION SPANNER SET RF TT1 8 PIECES****CONTENTS**

- » Ratcheting Combination Spanner Metric RF
- » 8, 10, 11, 12, 13, 14, 17, 19

Item ID: **TT6508RF****RATCHETING COMBINATION SPANNER SET R AF TT1 8 PIECES****CONTENTS**

- » Ratcheting Combination Spanner AF R
- » 5/16, 3/8, 7/16, 1/2, 9/16, 5/8, 11/16, 3/4"

Item ID: **TT6508RAF****RATCHETING COMBINATION SPANNER SET RS TT1 8 PIECES****CONTENTS**

- » Ratcheting Combination Spanner Metric RS
- » 8, 10, 11, 12, 13, 14, 17, 19

Item ID: **TT6508RS**



**STUBBY RATCHETING COMBINATION SPANNER SET TT  
10 PIECES**



**CONTENTS**

- » Stubby Ratcheting Combination Spanner Metric RS
- » 10, 11, 12, 13, 14, 15, 16, 17, 18, 19

Item ID: **TT6010MRS**



**DOUBLE RING SPANNER SET TTX4 11 PIECES**



**CONTENTS**

- » Double Ring Spanner Metric
- » 6 x 7, 8 x 9, 10 x 11, 12 x 13, 14 x 15, 16 x 17, 18 x 19, 20 x 22, 21 x 23, 24 x 27, 30 x 32

Item ID: **TTX6311**



**RATCHETING COMBINATION SPANNER SET RS TT1 11  
PIECES**



**CONTENTS**

- » Ratcheting Combination Spanner Metric RS
- » 8, 10, 11, 12, 13, 14, 15, 16, 17, 18, 19

Item ID: **TT6511RS**



**DOUBLE OPEN ENDED SPANNER SET AF TTX4 7 PIECES**



**CONTENTS**

- » Double Open Ended Spanner AF
- » 1/4" x 5/16", 3/8" x 7/16", 1/2" x 9/16", 5/8" x 3/4", 13/16" x 7/8", 15/16" x 1", 1-1/8" x 1-1/4"

Item ID: **TTX6607**



**DOUBLE RING SPANNER SET AF TTX4 7 PIECES****CONTENTS**

- » Double Ring Spanner AF
- » 1/4" x 5/16", 3/8" x 7/16", 7/16" x 1/2", 13/16" x 7/8", 15/16" x 1-1/16", 1" x 1-1/8", 1-1/8" x 1-1/4"

Item ID: **TTX6707****DOUBLE OPEN ENDED SPANNER SET TTI 8 PIECES****CONTENTS**

- » Double Open Ended Spanner Metric
- » 6 x 7, 8 x 9, 10 x 11, 12 x 13, 14 x 15, 16 x 17, 18 x 19, 20 x 22

Item ID: **TT6208****LONG DOUBLE RING SPANNER SET TTX4 6 PIECES****CONTENTS**

- » Long Double Ring Spanner Metric
- » 8 x 10, 11 x 13, 12 x 14, 16 x 18, 17 x 19, 22 x 24

Item ID: **TTXFLS06****DOUBLE FLEX WRENCH SET TTI 6 PIECES****CONTENTS**

- » Double Flex Wrench Metric
- » 8 x 9, 10 x 11, 12 x 13, 14 x 15, 16 x 17, 18 x 19

Item ID: **TT6506**



**RATCHETING RING SPANNER SET TTI 6 PIECES**



**CONTENTS**

- » Ratcheting Offset Ring Spanner Metric
- » 6 x 8, 7 x 9, 10 x 13, 12 x 14, 17 x 19, 21 x 22

Item ID: **TTRORS**



**HOOK & PIN WRENCH SET TTI 8 PIECES**



**CONTENTS**

- » Pin Wrench HP2014 Pin Arm
- » Pin Wrench HP2026 Pin 6 mm
- » Pin Wrench HP2038 Pin 8 mm
- » Pin Wrench HP2025 Pin Arm 6mm
- » Pin Wrench HP2036 Pin Arm 6mm
- » Hook Wrench 50 - 120mm
- » Hook Wrench 19 - 50mm
- » Hook Wrench 32 - 75mm

Item ID: **TTHP08**



**QUICK WRENCH SET TTX4 7 PIECES**



**CONTENTS**

- » Quick Wrench
- » 13, 17, 19, 22, 24, 27, 32

Item ID: **TTXQRS07**



**ADJUSTABLE WRENCH SET TTI 4 PIECES**



**CONTENTS**

- » Adjustable Wrench Wide Jaw 200mm
- » Adjustable Wrench TPR Grip 200mm
- » Adjustable Wrench TPR Grip 150mm
- » Adjustable Wrench TPR Grip 250mm

Item ID: **TTADJ04**





**SCREWDRIVER SET MIXED TTI 7 PIECES****CONTENTS**

- » PH Screwdriver
  - » PH0, PH1, PH2
- » Flat Screwdriver
  - » 0.5 x 3.0, 1.0 x 5.5, 1.2 x 6.5
- » PZ Screwdriver PZ2 x 100mm L Hex Shaft

Item ID: **TT917N****SCREWDRIVER SET FLAT & PH TTX4 8 PIECES****CONTENTS**

- » Flat Screwdriver
  - » 0.5 x 3.0, 1.0 x 5.5, 1.2 x 6.5 (x2), 1.2 x 8.0, 1.6 x 10.0
- » PH Screwdriver
  - » PH2, PH3

Item ID: **TTX918N****SCREWDRIVER SET MIXED TT2 14 PIECES****CONTENTS**

- » PZ Screwdriver
  - » PZ0, PZ1, PZ2 (x2)
- » PH Screwdriver
  - » PH0, PH1, PH2 (x2)
- » Flat Screwdriver
  - » 0.5 x 3.0, 0.6 x 3.5, 1.0 x 5.5 (x2), 1.2 x 6.5 (x2)

Item ID: **TTD914N****SCREWDRIVER SET TX & TPX TTI 7 PIECES****CONTENTS**

- » TPX Screwdriver
  - » TPX10, TPX15, TPX20, TPX25, TPX30
- » TX Screwdriver
  - » TX8, TX9

Item ID: **TT917TXN**



**SCREWDRIVER SET TX TT2 12 PIECES**



**CONTENTS**

- » TX Screwdriver
- » TX6, TX7, TX8, TX9, TX10, TX15, TX20, TX25, TX27, TX30, TX40, TX45

Item ID: **TTD912TXN**



**POWER THROUGH SCREWDRIVER SET TTX4 5 PIECES**



**CONTENTS**

- » PH Power Thru Screwdriver
- » PH2, PH3
- » Flat Power Thru Screwdriver
- » 1.2 x 6.5, 1.2 x 8, 1.6 x 10

Item ID: **TTXMDTN**



**SCREWDRIVER BLADE SET MIXED TTI 12 PIECES**



**CONTENTS**

- » Double Ended Screwdriver Blade
- » 0.8 x 4;1.0 x 5.5, 1.2 x 6.5;PH3, 3;3 Ballpoint, 4;4 Ballpoint, 5;5 Ballpoint, 6;6 Ballpoint, PH1;PH2, PZ1;PZ2, TX10;TX15, TX20;TX25, TX30;TX40

Item ID: **TTMD12D**



**MINI PLIERS & SCREWDRIVER SET TTI 16 PIECES**



**CONTENTS**

- » Mini Side Cutting Plier 115mm
- » Mini Screwdriver Set Flat & PH 6 Pieces
- » Mini Screwdriver Set TX 6 Pieces
- » Mini Flat Nose Plier 140mm
- » Mini Long Nose Plier 140mm
- » Mini End Cutting Plier 110mm

Item ID: **TTMI16**





**BITS DRIVER SET TTI 49 PIECES**

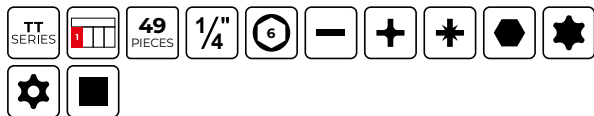

**CONTENTS**

- » Hex Socket Adaptor 1/4" Hex - 1/4" 30mm
- » 1/4" PH Bits 25mm
  - » PH1, PH2, PH3
- » 1/4" Socket 6 pt Metric
  - » 4, 5, 5.5, 6, 7, 8, 9, 10, 11, 12, 13
- » 1/4" PH Bits 89mm
  - » PH1, PH2
- » 1/4" TPX Bits 25mm
  - » TPX20, TPX25, TPX30
- » 1/4" Flat Bits 89mm 0.8 x 4.0mm 1 pc
- » 1/4" Hex Bits 25mm
  - » 2, 3, 4, 5, 6, 8
- » 1/4" TX Bits 89mm
  - » TX20, TX25, TX30
- » 1/4" TX Bits 25mm
  - » TX10, TX15, TX20, TX25, TX30, TX40
- » 1/4" PZ Bits 89mm PZ2 1 pc
- » 1/4" ROB Bits 25mm
  - » 1, 2, 3
- » 1/4" Hex Bits 89mm Hex 4mm 1 pc
- » 1/4" PZ Bits 25mm
  - » PZ1, PZ2, PZ3
- » 1/4" Flat Bits 25mm
  - » 0.6 x 3.5, 1.0 x 5.5, 1.6 x 8.0
- » 1/4" Ratchet Head Hex/Square Drive
- » 1/4" Quick Chuck Bits Driver 147mm

Item ID: **TTMDQ49**



**BITS DRIVER SET TTI 76 PIECES**

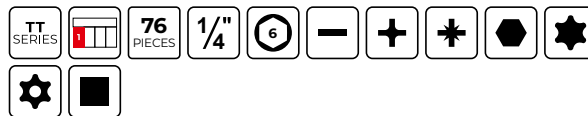

**CONTENTS**

- » Hex Socket Adaptor 1/4" Hex - 1/4" 30mm
- » 1/4" TX Bits 25mm
  - » TX6, TX7, TX8, TX9, TX10, TX15, TX20, TX25, TX27, TX30, TX40
- » 1/4" PH Bits 25mm
  - » PH1, PH2, PH3
- » 1/4" Socket 6 pt Metric
  - » 4, 5, 5.5, 6, 7, 8, 9, 10, 11, 12, 13
- » 1/4" TPX Bits 25mm
  - » TPX10, TPX15, TPX20, TPX25, TPX27, TPX30, TPX40
- » 1/4" Hex Bits 25mm
  - » 2, 3, 4, 5, 6, 8
- » 1/4" PH G Bits 25mm PH2G
- » 1/4" ROB Bits 25mm
  - » 1, 2, 3
- » 1/4" Flat Bits 25mm
  - » 0.6 x 3.5, 0.6 x 4.5, 0.8 x 4.0, 0.8 x 5.5, 1.0 x 5.5, 1.2 x 6.5, 1.6 x 8.0
- » 1/4" PZ Bits 25mm
  - » PZ1, PZ2, PZ3
- » 1/4" Quick Chuck Bits Driver 217mm

Item ID: **TTMDQ76**





**T-HANDLE BITS DRIVER SET TTI 62 PIECES**

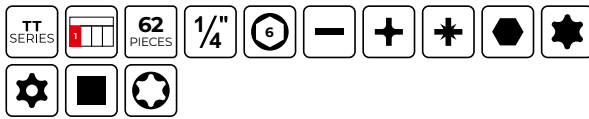

**CONTENTS**

- » Hex Socket Adaptor 1/4" Hex - 1/4" 30mm
- » 1/4" TX Bits 25mm  
TX6, TX7, TX8, TX9, TX10, TX15, TX20, TX25, TX27, TX30, TX40
- » 1/4" PH Bits 25mm  
PH1, PH2, PH3
- » 1/4" Socket 6 pt Metric  
5, 5.5, 6, 7, 8, 9, 10, 11, 12, 13
- » 1/4" TPX Bits 25mm  
TPX10, TPX15, TPX20, TPX25, TPX27, TPX30, TPX40
- » 1/4" Hex Bits 25mm  
2, 3, 4, 5, 6, 8
- » 1/4" T Handle Quick Chuck Bits Driver
- » 1/4" PH G Bits 25mm PH2G
- » 1/4" ROB Bits 25mm  
1, 2, 3
- » 1/4" TX-E Socket  
E4, E5, E6, E7, E8
- » 1/4" PZ Bits 25mm  
PZ1, PZ2, PZ3
- » 1/4" Flat Bits 25mm  
0.6 x 3.5, 1.0 x 5.5, 1.6 x 8.0

Item ID: **TTTHQ62**



**RATCHETING BITS DRIVER SET TTI 84 PIECES**

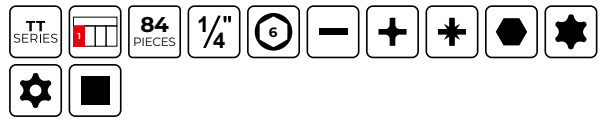

**CONTENTS**

- » Hex Socket Adaptor 1/4" Hex - 1/4" 30mm
- » 1/4" TX Bits 25mm  
TX6, TX7, TX8, TX9, TX10, TX15, TX20, TX25, TX27, TX30, TX40
- » 1/4" PH Bits 25mm  
PH1, PH2, PH3
- » 1/4" Socket 6 pt Metric  
4, 5, 5.5, 6, 7, 8, 9, 10, 11, 12, 13
- » 1/4" TPX Bits 25mm  
TPX10, TPX15, TPX20, TPX25, TPX27, TPX30, TPX40
- » 1/4" Hex Bits 25mm  
2, 3, 4, 5, 6, 8
- » 1/4" PH G Bits 25mm PH2G
- » 1/4" Ratcheting Quick Chuck Bits Driver
- » 1/4" ROB Bits 25mm  
1, 2, 3
- » 1/4" Flat Bits 25mm  
0.6 x 3.5, 0.6 x 4.5, 0.8 x 4.0, 0.8 x 5.5, 1.0 x 5.5, 1.2 x 6.5, 1.6 x 8.0
- » 1/4" PZ Bits 25mm  
PZ1, PZ2, PZ3
- » 1/4" Bits Driver Extension 150mm Flexible

Item ID: **TTMDR84**





**BITS DRIVER SET TTI 38 PIECES**

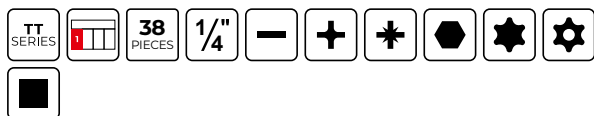

**CONTENTS**

- » 1/4" PH Bits 25mm
  - » PH1, PH2, PH3
- » 1/4" PH Bits 89mm
  - » PH1, PH2
- » 1/4" TPX Bits 25mm
  - » TPX20, TPX25, TPX30
- » 1/4" Flat Bits 89mm
  - » 0.5 x 3.0, 0.8 x 4.0
- » 1/4" Hex Bits 25mm
  - » 2, 3, 4, 5, 6, 8
- » 1/4" TX Bits 89mm
  - » TX10, TX20, TX25
- » 1/4" TX Bits 25mm
  - » TX10, TX15, TX20, TX25, TX30, TX40
- » 1/4" PZ Bits 89mm
  - » PZ1, PZ2
- » 1/4" ROB Bits 25mm
  - » 1, 2, 3
- » 1/4" PZ Bits 25mm
  - » PZ1, PZ2, PZ3
- » 1/4" Flat Bits 25mm
  - » 0.6 x 3.5, 1.0 x 5.5, 1.6 x 8.0
- » 1/4" Quick Chuck Bits Driver 183mm
- » 1/4" Quick Chuck Bits Driver 147mm

Item ID: **TTMDQ38**



**RATCHETING SCREWDRIVER BIT SET TTI 74 PIECES**

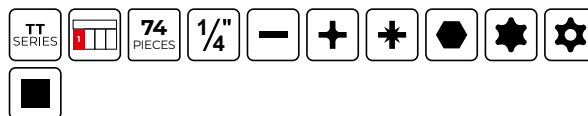

**CONTENTS**

- » Hex Socket Adaptor 1/4" Hex - 1/4" 30mm
- » 1/4" TX Bits 25mm
  - » TX6, TX7, TX8, TX9, TX10, TX15, TX20, TX25, TX27, TX30, TX40
- » 1/4" PH Bits 25mm
  - » PH1, PH2, PH3
- » 1/4" TPX Bits 25mm
  - » TPX10, TPX15, TPX20, TPX25, TPX27, TPX30, TPX40
- » 1/4" Hex Bits 25mm
  - » 2, 3, 4, 5, 6, 8
- » 1/4" Bits Driver Extension 100mm
- » 1/4" Bits Driver Extension 150mm Flexible
- » 1/4" Flat Bits 25mm
  - » 0.6 x 3.5, 0.6 x 4.5, 0.8 x 4.0, 0.8 x 5.5, 1.2 x 6.5, 1.6 x 8.0, 7
- » 1/4" PH G Bits 25mm PH2G
- » 1/4" ROB Bits 25mm
  - » 1, 2, 3
- » 1/4" PZ Bits 25mm
  - » PZ1, PZ2, PZ3
- » 1/4" Ratcheting Bits Driver Set
- » 1/4" Bit Adaptor Hex Bit Coupler

Item ID: **TTMD74**







**ANGLED RATCHETING BITS DRIVER SET TTI 64 PIECES**



**CONTENTS**

- » 1/4" TX Bits 25mm  
TX6, TX7, TX8, TX9, TX10, TX15, TX20, TX25, TX27, TX30, TX40
- » 1/4" PH Bits 25mm  
PH1, PH2, PH3
- » 1/4" Socket 6 pt Metric  
4, 5, 5.5, 6, 7, 8, 9, 10, 11, 12, 13
- » 1/4" Hex Bits 25mm  
2, 3, 4, 5, 6, 8
- » 1/4" Ratcheting Angled Bits Driver Set
- » 1/4" PH G Bits 25mm PH2G
- » 1/4" ROB Bits 25mm  
1, 2, 3
- » 1/4" Flat Bits 25mm  
0.6 x 3.5, 0.6 x 4.5, 0.8 x 4.0, 0.8 x 5.5, 1.0 x 5.5, 1.2 x 6.5, 1.6 x 8.0
- » 1/4" PZ Bits 25mm  
PZ1, PZ2

Item ID: **TTMDRT64**



**SOCKET & BIT SET FLEXIBLE HANDLE TTX4 41 PIECES**



**CONTENTS**

- » 1/4" TX Bits 25mm  
TX8, TX10, TX15, TX20, TX25, TX27, TX30, TX40
- » 1/4" PH Bits 25mm  
PH0, PH1, PH2, PH3 (x2)
- » 1/4" Socket 6 pt Metric  
4, 4.5, 5, 5.5, 6, 7, 8, 9, 10, 11, 12, 13
- » 1/4" Long Flexible Bits Driver
- » 1/4" Hex Bits 25mm  
3, 4, 5, 6, 8, 10
- » 1/4" Extra Long Flexible Socket Driver 555mm
- » 1/4" Flat Bits 25mm  
0.8 x 4.0, 0.8 x 5.5, 1.6 x 8.0
- » 1/4" PZ Bits 25mm  
PZ0, PZ1, PZ2, PZ3
- » Hex Socket Adaptor 1/4" Hex - 1/4" 25mm

Item ID: **TTXMD41N**





**IMPACT BIT SET TTI 53 PIECES**



**CONTENTS**

- » 1/4" PZ Impact Bits 30mm  
PZ1, PZ2, PZ3
- » 1/4" Impact Nut Setter  
1/4, 8, 10, 13
- » 1/4" TX Impact Bits 30mm  
TX10, TX15, TX20, TX25, TX27, TX30, TX40
- » 1/4" ROB Impact Bits 50mm  
1, 2, 3
- » 1/4" PH G Impact Bits 30mm PH2G 1 pc
- » 1/4" PH Impact Bits 89mm PH2 1 pc
- » 1/4" Hex Impact Bits 30mm  
3, 4, 5, 6
- » 1/4" PH Impact Bits 30mm  
PH1, PH2, PH3
- » 1/4" Hex Impact Bits 50mm  
3, 4, 5, 6
- » 1/4" TX Impact Bits 89mm  
TX20, TX25, TX30
- » 1/4" Magnetic Impact Bit Holder 60mm
- » 1/4" ROB Impact Bits 30mm  
1, 2
- » 1/4" TX Impact Bits 50mm  
TX10, TX15, TX20, TX25, TX27, TX30, TX40
- » 1/4" PZ Impact Bits 50mm PZ2 1 pc
- » 1/4" Quick Chuck Impact Bit Holder 60mm
- » 1/4" PH G Impact Bits 50mm PH2G 1 pc

Item ID: **TTBS53**



**T-HANDLE BALL POINT HEX KEY SET TTI 7 PIECES**



**CONTENTS**

- » T Handle Ball Point Hex Key Metric
- » 2.5, 3, 4, 5, 6, 7, 8

Item ID: **TTHEX7**

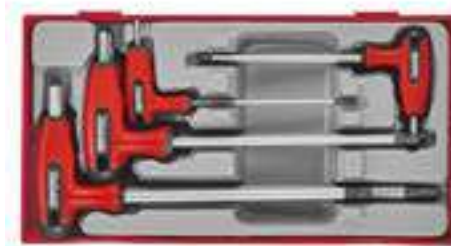

**T-HANDLE HEX KEY SET TTI 7 PIECES**



**CONTENTS**

- » T Handle Hex Key Metric
- » 2.5, 3, 4, 5, 6, 7, 8

Item ID: **TTHEX7S**





**T-HANDLE BALL POINT HEX KEY SET AF TTI 7 PIECES**



**CONTENTS**

- » T Handle Ball Point Hex Key AF
- » 1/4, 1/8, 3/16, 3/32, 5/16, 5/32, 7/32

Item ID: **TTHEX7AF**



**BALL POINT HEX & TX KEY SET TTI 28 PIECES**



**CONTENTS**

- » Ball Point Hex Key Metric 7mm
- » Ball Point Hex Key Set 9 Pieces
- » Ball Point Hex Key Set AF 9 Pieces
- » TX Key Set 9 Pieces

Item ID: **TTHT28**



**T-HANDLE TX/TPX KEY SET TTI 7 PIECES**



**CONTENTS**

- » T Handle Ball Point TX Key
- » TX10, TX15, TX20, TX25, TX27, TX30, TX40

Item ID: **TTTX7**



**NUT DRIVER SET TTX4 9 PIECES**



**CONTENTS**

- » Nut Driver
- » 5, 5.5, 6, 7, 8, 10, 11, 12, 13

Item ID: **TTXND**





**PLIER SET VINYL GRIP TTI 4 PIECES**



**CONTENTS**

- » Water Pump Plier 240mm
- » Heavy Duty Combination Plier 185mm
- » Long Nose Plier 200mm
- » Side Cutting Plier 160mm

Item ID: **TT440**



**PLIER SET TPR GRIP TTI 4 PIECES**



**CONTENTS**

- » Side Cutting Plier TPR Grip 160mm
- » Water Pump Plier TPR Grip 250mm
- » Heavy Duty Combination Plier TPR Grip 190mm
- » Long Nose Plier TPR Grip 205mm

Item ID: **TT440-T**



**NEW**



**PLIER SET VINYL GRIP Q TTI 4 PIECES**



**CONTENTS**

- » Quick Set Water Pump Plier HRC60 250mm
- » Heavy Duty Combination Plier 185mm
- » Long Nose Plier 200mm
- » Side Cutting Plier 160mm

Item ID: **TT440Q**



**NEW**



**PLIER SET TPR GRIP Q TTI 4 PIECES**



**CONTENTS**

- » Quick Set Water Pump Plier TPR Grip HRC60 250mm
- » Side Cutting Plier TPR Grip 160mm
- » Heavy Duty Combination Plier TPR Grip 190mm
- » Long Nose Plier TPR Grip 205mm

Item ID: **TT440-TQ**





**PLIER SET VINYL GRIP TT2 8 PIECES**



**CONTENTS**

- » Long Nose Plier 165mm
- » Long Nose Plier 200mm
- » Water Pump Plier 180mm
- » Water Pump Plier 240mm
- » Heavy Duty Combination Plier 200mm
- » Heavy Duty Combination Plier 165mm
- » Heavy Duty Side Cutting Plier 160mm
- » Heavy Duty Side Cutting Plier 200mm

Item ID: **TTD441**



**PLIER SET TPR GRIP TT2 8 PIECES**



**CONTENTS**

- » Water Pump Plier TPR Grip 185mm
- » Water Pump Plier TPR Grip 250mm
- » Heavy Duty Combination Plier TPR Grip 200mm
- » Heavy Duty Combination Plier TPR Grip 170mm
- » Heavy Duty Side Cutting Plier TPR Grip 165mm
- » Heavy Duty Side Cutting Plier TPR Grip 200mm
- » Long Nose Plier TPR Grip 205mm
- » Long Nose Plier TPR Grip 170mm

Item ID: **TTD441-T**







NEW



**PLIER SET VINYL GRIP Q TT2 8 PIECES**



CONTENTS

- » Quick Set Water Pump Plier HRC60 185mm
- » Quick Set Water Pump Plier HRC60 250mm
- » Long Nose Plier 165mm
- » Long Nose Plier 200mm
- » Heavy Duty Combination Plier 200mm
- » Heavy Duty Combination Plier 165mm
- » Heavy Duty Side Cutting Plier 160mm
- » Heavy Duty Side Cutting Plier 200mm

Item ID: **TTD441Q**



**PLIER & WRENCH SET TTX4 2 PIECES**



CONTENTS

- » Adjustable Wrench Alligator 200mm
- » Quick Set Water Pump Plier HRC60 250mm

Item ID: **TTXMB02**

**CIRCLIP PLIER SET 12-25 MM TTI 4 PIECES**



CONTENTS

- » Circlip Plier Inner Bent 135mm
- » Circlip Plier Inner Straight 145mm
- » Circlip Plier Outer Straight 145mm
- » Circlip Plier Outer Bent 125mm

Item ID: **TT474-5**



**CIRCLIP PLIER SET PRO 10-25 MM TTI 4 PIECES**



CONTENTS

- » Circlip Plier Outer Bent PRO 125mm
- » Circlip Plier Inner Bent PRO 125mm
- » Circlip Plier Outer Straight PRO 135mm
- » Circlip Plier Inner Straight PRO 135mm

Item ID: **TT474-5E**





**CIRCLIP PLIER SET 19-60 MM TTI 4 PIECES**



**CONTENTS**

- » Circlip Plier Inner Straight 185mm
- » Circlip Plier Outer Straight 180mm
- » Circlip Plier Outer Bent 165mm
- » Circlip Plier Inner Bent 170mm

Item ID: **TT474-7**



**CIRCLIP PLIER SET 40-100 MM TTX4 4 PIECES**



**CONTENTS**

- » Circlip Plier Inner Straight 250mm
- » Circlip Plier Outer Bent 225mm
- » Circlip Plier Outer Straight 240mm
- » Circlip Plier Inner Bent 235mm

Item ID: **TTX474-9**



**CIRCLIP PLIER SET PRO 19-60 MM TTI 4 PIECES**



**CONTENTS**

- » Circlip Plier Inner Straight PRO 175mm
- » Circlip Plier Outer Bent PRO 165mm
- » Circlip Plier Outer Straight PRO 175mm
- » Circlip Plier Inner Bent PRO 175mm

Item ID: **TT474-7E**



**CIRCLIP PLIER SET PRO 40-100 MM TTX4 4 PIECES**



**CONTENTS**

- » Circlip Plier Outer Straight PRO 225mm
- » Circlip Plier Outer Bent PRO 220mm
- » Circlip Plier Inner Bent PRO 220mm
- » Circlip Plier Inner Straight PRO 225mm

Item ID: **TTX474-9E**





**POWER GRIP PLIER SET TTI 5 PIECES**



**CONTENTS**

- » Long Nose Power Grip Plier 125mm
- » Long Nose Power Grip Plier 170mm
- » Curved Jaw Power Grip Plier 235mm
- » Curved Jaw Power Grip Plier 105mm
- » Curved Jaw Power Grip Plier 190mm

Item ID: **TTVG05**



**POWER GRIP PLIER SET TTX2 3 PIECES**



**CONTENTS**

- » Long Nose Power Grip Plier 125mm
- » Long Nose Power Grip Plier 170mm
- » Curved Jaw Power Grip Plier 105mm

Item ID: **TTZVG03**



**POWER GRIP PLIER SET TT4 4 PIECES**



**CONTENTS**

- » Sheet Metal Power Grip Plier 230mm
- » Welding Power Grip Plier 230mm
- » Long Nose Power Grip Plier 170mm
- » C Clamp Power Grip Plier 280mm

Item ID: **TTPSPG**



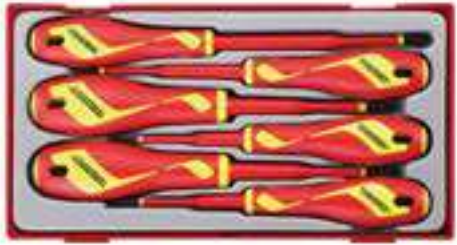

**INSULATED SCREWDRIVER SET MIXED TTI 6 PIECES**



**CONTENTS**

- » Flat Slim Insulated Screwdriver  
0.8 x 4.0, 1.0 x 5.5
- » PH Slim Insulated Screwdriver  
PH1, PH2
- » PZ Slim Insulated Screwdriver  
PZ1, PZ2

Item ID: **TTV706N**



**INSULATED SCREWDRIVER SET MIXED TT2 10 PIECES**



**CONTENTS**

- » Flat Insulated Screwdriver  
0.4 x 2.5, 0.5 x 3.0, 0.8 x 4.0, 1.0 x 5.5
- » PZ Insulated Screwdriver  
PZ0, PZ1, PZ2
- » PH Insulated Screwdriver  
PH0, PH1, PH2

Item ID: **TTDV910N**



**INSULATED SCREWDRIVER SET MIXED TTI 7 PIECES**



**CONTENTS**

- » Flat Insulated Screwdriver  
0.4 x 2.5, 0.8 x 4.0, 1.0 x 5.5
- » PZ Insulated Screwdriver PZ2
- » PH Insulated Screwdriver  
PH0, PH1, PH2

Item ID: **TTV907N**



**INSULATED SCREWDRIVER SET INTERCHANGEABLE BLADES TTI 10 PIECES**



**CONTENTS**

- » Interchangeable Blade Insulated Screwdriver  
3, 4, 5.5, 6.5, PH1, PH2, PZ1, PZ2
- » Insulated Handle for Interchangeable Blades S
- » Insulated Handle for Interchangeable Blades L

Item ID: **TTV710N**





**INSULATED TORQUE SCREWDRIVER SET TTI 9 PIECES**



**CONTENTS**

- » Interchangeable Blade Insulated Screwdriver  
3, 4, 5.5, 6.5, PH1, PH2, PZ1, PZ2
- » Insulated Torque Screwdriver 1-5Nm

Item ID: **TTVSD09**



**3/8" INSULATED SOCKET SET TTI 14 PIECES**



**CONTENTS**

- » 3/8" Insulated Socket  
8, 9, 10, 11, 12, 13, 14, 15, 16, 17, 18, 19
- » 3/8" Insulated Extension Bar 75mm
- » 3/8" Insulated Ratchet

Item ID: **TTV3814**



**INSULATED PLIER SET TTI 4 PIECES**



**CONTENTS**

- » Insulated Long Nose Plier 215mm
- » Insulated Wire Stripping Plier
- » Insulated Combination Plier 185mm
- » Insulated Side Cutting Plier 160mm

Item ID: **TTV440**



**CUTTING TOOL SET TT2 5 PIECES**

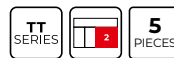

**CONTENTS**

- » Tin Snip Right/Straight
- » Tin Snip Left/Straight
- » Scissors 5-1/2"
- » Quick Action Utility Knife
- » Heavy Duty Cable Cutter Bi Material Handle 250mm

Item ID: **TTDCT05**







**NEW**



**CUTTING TOOL SET TT2 6 PIECES**

TT SERIES 6 PIECES

**CONTENTS**

- » Scissors 5-1/2"
- » Compact tin snip straight cut Cr-Mo 190mm
- » Compact tin snip straight/right cut Cr-Mo 182mm
- » Compact tin snip straight/left cut Cr-Mo 182mm
- » Deburring Tool Pocket Clip
- » Scriber With Carbide Tip

Item ID: **TTDCT06**

**KNIFE SET TTI 40 PIECES**

TT SERIES 40 PIECES

**CONTENTS**

- » Replacement Snap Off Blades 9mm 10 pcs
- » Replacement Blades Mini Folding Utility Knife 10 pcs
- » Snap Off Knife 18mm Plastic Housing
- » Replacement Snap Off Blades 18mm 10 pcs
- » Folding Utility Knife
- » Safety Utility Knife
- » Mini Folding Utility Knife
- » Snap Off Knife Knife 9mm Plastic Housing

Item ID: **TTK40**





### DRILL BIT SET 1.0-13.0 MM TT2 28 PIECES



#### CONTENTS

- » Drill Bits Fully Ground
- » 1, 1.5, 2, 2.5, 3, 3.5, 4, 4.5, 5, 5.5, 6, 6.5, 7, 7.5, 8, 8.5, 9, 10, 10.5, 11, 12, 13

Item ID: **TTDB28**



### TAP AND DIE SET TT1 17 PIECES

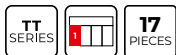

#### CONTENTS

- » Tap
- » M10x1,5, M12x1,75, M3x0,5, M4x0,7, M5x0,8, M6x1,0, M8x1,25
- » Die
- » M10x1,5, M12x1,75, M3x0,5, M4x0,7, M5x0,8, M6x1,0, M8x1,25
- » Tap Handle
- » Die Handle M3 - M12
- » Pitch Gauge

Item ID: **TTTD17**



### TAP AND DIE SET TT2 34 PIECES

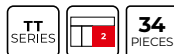

#### CONTENTS

- » Tap
- » M10x1,5, M12x1,75, M3x0,5, M4x0,7, M5x0,8, M6x1,0, M8x1,25
- » Reducing Adaptor 3/8" F - 1/4" M
- » Pitch Gauge
- » Screw Extractor
- » 1, 2, 3, 4, 5
- » Die
- » M10x1,5, M12x1,75, M3x0,5, M4x0,7, M5x0,8, M6x1,0, M8x1,25
- » Drill Bits Fully Ground
- » 2.5, 3.3, 4.2, 5, 6.8, 8.5, 10.5
- » Hex Mini Screwdriver 2.5
- » 1/4" Mini Palm Ratchet 45 Teeth
- » 1/4" Die Chuck M5 - M12
- » 1/4" Tap Chuck M5 - M12
- » 1/4" Tap Chuck M3 - M8
- » 1/4" Extension Bar 100mm

Item ID: **TTDTD34**





**NEEDLE FILE SET TTI 12 PIECES**

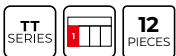

**CONTENTS**

- » Needle File Oval
- » Needle File Square
- » Needle File Round edge flat
- » Needle File Knife type
- » Needle File Crossing
- » Needle File Triangular
- » Needle File Half round
- » Needle File Round
- » Needle File Barrette
- » Needle File Flat point
- » Needle File Flat
- » Needle File Feather

Item ID: **TTNF12**



**HAND FILE SET TTX4 5 PIECES**

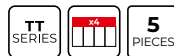

**CONTENTS**

- » Hand File 250mm Half round
- » Hand File 250mm Round
- » Hand File 250mm Triangular
- » Hand File 250mm Flat Tapered
- » Hand File 250mm Flat

Item ID: **TTXF05**



**MEASURING TOOL SET TTI 4 PIECES**

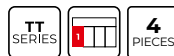

**CONTENTS**

- » Square Base 100 x 70mm
- » Scriber With Carbide Tip
- » Vernier Caliper 0-150mm
- » Steel Rule mm/AF 150mm

Item ID: **TTBM**





**MEASURING TOOL SET TT2 4 PIECES**



**CONTENTS**

- » Gauge Thread MM/UNC 0,25-6,0mm
- » Feeler Gauge 0,05-1,0mm 100mm 20 Blades
- » Digital Multimeter
- » Digital Caliper 0-150mm

Item ID: **TTDCM**



**SCRAPER SET TTI 4 PIECES**

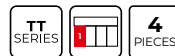

**CONTENTS**

- » Awl Round Tip
- » Hook Tool Curved
- » Cotter Pin Puller
- » Gasket Scraper 22mm

Item ID: **TTSR04**



**HOCK & PICK SET TTI 4 PIECES**



**CONTENTS**

- » Hook Tool 125°
- » Hook Tool 90°
- » Hook Tool 35°
- » Awl Straight

Item ID: **TTMDP**



**HOSE CLAMP SET TTI 3 PIECES**

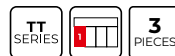

**CONTENTS**

- » Hose Clamp 19 - 57mm
- » Hose Clamp 6 - 19mm
- » Hose Clamp 6 - 32mm

Item ID: **TTHC03**





**AUTOMOTIVE SOCKET SET TT1 7 PIECES**



**CONTENTS**

- » 3/8" Drive Sockets
- » 22mm - Oxygen sensor socket for Mitsubishi, Nissan, Opel, Vauxhall & VW
- » 7/8" - Vacuum switch socket
- » 1-11/16" - Oil sender socket
- » 7/8" - Offset oxygen sensor socket
- » 1/2" Drive Sockets
- » 29mm - Oxygen sensor socket for GM
- » 27mm - Injector socket for M24
- » 7/8" - Heated oxygen sensor socket

Item ID: **TTSS07**



**OIL SERVICE SET TT1 16 PIECES**



**CONTENTS**

- » Drain Plug
- » 11, 13, 17 x 1/2", 5/16 x 3/8, 8 x 10, 8 x 3/8"
- » Reducing Adaptor 1/2"F - 3/8"M
- » Feeler Gauge 0,05-1,0mm 100mm 20 Blades
- » 3/8" Wobble Extension Bar 255mm
- » 3/8" Spark Plug Socket
- » 16, 21
- » Telescopic Inspection Tool 3 in 1
- » 3/8" Extension Bar 75mm
- » 3/8" Socket 6 pt Metric 21mm
- » 1/2" Oil Filter Removal Tool Strap Type 130mm

Item ID: **TTOS16**





**3/8" T BAR SPARK PLUG SOCKET SET TTX4 5 PIECES**



**CONTENTS**

- » 3/8" T-Bar Spark Plug Socket (Magnetic)
- » 14, 16, 21
- » T Bar Handle Grip
- » T Bar for T Bar Sockets

Item ID: **TTXTB05**



**FLARING TOOL SET TTI 10 PIECES**

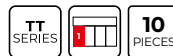

**CONTENTS**

- » Pipe Cutter 3–32 mm (1/8"–1/4")
- » Adaptors: 4, 4.75 (3/16"), 6 (1/4"), 8 (5/16"), 10, 12, 14 mm

Item ID: **TTTF10**



**3/8" LONG T BAR SOCKET SET TTX4 9 PIECES**



**CONTENTS**

- » 3/8" T-Bar Deep Socket 6 pt Metric
- » 8, 10, 12, 13, 14, 17, 19
- » T Bar Handle Grip
- » T Bar for T Bar Sockets

Item ID: **TTXTB09**



**BODYWORK HAMMER SET TT4 5 PIECES**



**CONTENTS**

- » Body Working Hammer Round Crown Face/Square Milled
- » Body Working Hammer Round Crown Face/Point Pin
- » Body Working Hammer Round Crown Face/Straight Pein
- » Hammer Dead Blow 55mm Diameter Head 980g
- » Hammer Dead Blow 35mm Diameter Head 300g

Item ID: **TTPSAD**







**PULLER SET TTI 4 PIECES**



**CONTENTS**

- » Combination twin/triple 6" leg puller with 4" capacity

Item ID: **TT804**



**STUD EXTRACTOR SET TTI 18 PIECES**



**CONTENTS**

- » 3/8" Stud Extractor  
1/2, 11/16, 6, 8, 10, 11, 12, 13, 14, 16, 17, 3/8
- » 1/2" Stud Extractor  
19, 21, 22, 24, 25
- » Parallel Pin Punch 4mm

Item ID: **TTBE18**



**EXTRACTOR & NUT SPLITTER SET TTI 11 PIECES**



**CONTENTS**

- » Nut Splitter Set 2 Pieces
- » 1/2" Stud Extractor Socket  
6, 8, 10, 12
- » Screw Extractor Set Spiral 5 Pieces

Item ID: **TTSN11**



**PRY BAR SET ROLL/HEEL TTX4 3 PIECES**

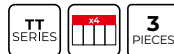

**CONTENTS**

- » Pry Bar Roll Heel Type 400mm
- » Pry Bar Roll Heel Type 500mm
- » Pry Bar Roll Heel Type 300 mm

Item ID: **TTXPB3**





**PRY BAR SET TTX4 3 PIECES**



**CONTENTS**

- » Pry Bar 450mm
- » Pry Bar 300mm
- » Pry Bar 550mm

Item ID: **TTXPB3A**



**CRIMPING PLIER SET TTI 4 PIECES**



**CONTENTS**

- » Ratcheting Crimping Plier With Three Heads

Item ID: **TTCP04**



**CRIMPING PLIER SET TTI 121 PIECES**



**CONTENTS**

- » Crimping Plier 9" Red Handle

Item ID: **TTCP121**



**PIPE CUTTER SET TTI 6 PIECES**

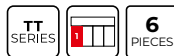

**CONTENTS**

- » Rotating Pipe Cutter 22mm
- » Rotating Pipe Cutter 10mm
- » Rotating Pipe Cutter 15mm
- » Rotating Pipe Cutter 12mm
- » Deburring Tool
- » Pipe Cutter 3 - 22mm

Item ID: **TTTC06**





**RIVET GUN SET TTI 81 PIECES**

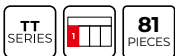

**CONTENTS**

- » Rivet Gun
- » 4 nozzles to suit aluminium/steel blind rivets (2.4, 3.2, 4.0, 4.8 mm)
- » Aluminium Rivets: 2.4mm x 20, 3.2mm x 20, 4.0mm x 20, 4.8mm x 20
- » Nozzle wrench

Item ID: **TTHR81**



**INSPECTION SET TTI 3 PIECES**

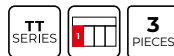

**CONTENTS**

- » Telescopic Magnifying Glass
- » Telescopic Inspection Mirror
- » Telescopic Magnetic Pick Up Tool 760mm

Item ID: **TTTM03**



**NUTSERT GUN SET TTI 81 PIECES**



**CONTENTS**

- » Nutsert Gun
- » 4 quick change mandrels (M3 x 0.5, M4 x 0.7, M5 x 0.8, M6 x 1.0)
- » Aluminium rivets: M3 x 20, M4 x 20, M5 x 20, M6 x 20
- » Nose piece wrench

Item ID: **TTNR81**



**INSPECTION SET TTI 8 PIECES**

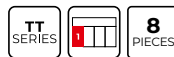

**CONTENTS**

- » LED flashlight
- » Flexible magnetic pick up, length 310mm
- » Telescopic magnetic pick up, length 160-480mm
- » 38mm magnifying glass 1:3 with magnetic adaptor
- » 38mm inspection mirror with magnetic adaptor
- » 230mm flexible claw pick up tool
- » Batteries AAA (2 pieces)

Item ID: **TTTM08**



**PUNCH & CHISEL SET TTI 9 PIECES****CONTENTS**

- » Parallel Pin Punches: 3, 4, 5, 6, 7, 8mm
- » Centre Punch 5mm
- » Flat Cold Chisel
- » 18, 25

Item ID: **TTPC09****NEW****CLIP & PANEL REMOVER SET TTI 4 PIECES****CONTENTS**

- » Trim clip removal tool V-shape
- » Trim clip removal tool V-shape large
- » Panel clip removal tool U-shape large
- » Panel clip removal tool U-shape

Item ID: **TTSR04A**

# FOAM SERIES TOOL KITS

## BETTER TOOLS BRING BETTER RESULTS

Each tool kit has been compiled with the help of technicians from various trades and are available in many shapes and sizes. From full stacks to roller cabinets, and top boxes to portable solutions, there is a kit to fit your exact needs

### FOAM SERIES

---



**Protection:** FOAM Series tool trays provide a protective layer between the tools and the storage solution, helping to prevent damage and scratching.



**Organisation:** Each tool has its own place with its description imprinted in the 3-coloured foam. The contrasting colours make it easy to identify tools and see when a tool is missing.



**Customisability:** We can provide a bespoke custom FOAM Series toolkit based around your existing tools and equipment. Contact your local retailer for more information.



**Safety:** FOAM Series tool trays can also help reduce the risk of injury by keeping sharp or dangerous tools secure and separated from other tools.



**Cold environments:** The high quality FOAM stays soft and flexible even in cold environments and gives the tool kit a premium look.











**PRO35™**

**MONSTER™**

**NEW**

**53" PRO35™ MONSTER STACK FOAM TOOL KIT 1133 PIECES RED**

**1133**  
PIECES

**FOAM**  
SERIES



- 19** Drawer
- 3-Piece Cabinet Frame**
- Heavy Gauge Steel**
- 5-Step Phosphate-Free Rust Protection**
- 53" Wide Cabinet**
- 6" x 2" Castor Wheels with Brakes**
- 3 Step Ball Bearing Slides**
- Comfort Grip Handle**
- Combination Lock**





Drawer	Item ID	Description
	TST53R10F	53" PRO35™ tool chest 10 drawers red
	TSW53R9	53" PRO35™ roller cabinet 9 drawers red
	TCF07	Fixing brackets for 26", 37" & 53" deep tool chest
	TCA08	Paper roll holder for side handle
1/10	TEABS50	Impact Bit Set FOAM1
1/10	TEAMDQ78	Bits Driver Set FOAM1
1/10	TEAHR81	Rivet Gun Set FOAM1
1/10	TEAMDV10	Insulated Interchangeable Blade Set FOAM1
1/10	TEXEXT13	Extension Bars Set FOAMX4
2/10	TEDV3818	3/8" Insulated Socket Set FOAM2
2/10	TEDV440	Insulated Plier Set FOAM2
2/10	TEXTB05	3/8" T Bar Spark Plug Socket Set FOAMX4
3/10	TEDSD14	Torque Screwdriver Set FOAM2
3/10	TEDHT42	Ball Point Hex & TX Key Set FOAM2
3/10	TEXMDTN	Power Through Screwdriver Set FOAMX4
4/10	TEDPCI4	Punch & Chisel Set FOAM2
4/10	TEDDF7	Double Flex Wrench Set FOAM2
4/10	TEXFLS06	Long Double Ring Spanner Set FOAMX4
5/10	TEDADJ4	Adjustable Wrench Set FOAM2
5/10	TEDIMM	Measuring Tool Set FOAM2
5/10	TEXPB4	Pry Bar Set Roll/Heel FOAMX4
6/10	TEX1238	3/8" & 1/2" Torque Wrench Set FOAMX4
6/10	TEXW05	Wheel Tool Set FOAMX4
7/10	TTEVG11	Power Grip Plier Set FOAM4X4
8/10	TTEMB14Q	Plier Set Vinyl Grip Q FOAM4X4
9/10	TTEMD122N	Screwdriver Set Mixed FOAM4X4
10/10	TTEX23N	Nut Driver & Hex/TX T-Handle Set FOAM4X4
1/9	TTESK86	1/4" & 3/8" Socket Set FOAM4X4
1/9	TTESK63	1/2" Socket Set 12 pt FOAM4X4
2/9	TTESK85	1/4", 3/8" & 1/2" Socket Set FOAM4X4
3/9	TTEPS12	General Tool Set FOAM4X4
4/9	TTESP37	Spanner Set FOAM4X4
5/9	TTESP31	Combination Spanner Set FOAM4X4
6/9	TTEAF62	Socket & Combination Spanner Set AF FOAM4X4
7/9	TTEISK73	3/8" & 1/2" Impact Socket Set FOAM4X4
8/9	TTESK32	3/4" Socket Set FOAM4X4
9/9	TTEISK33	3/4" Impact Socket Set DIN FOAM4X4

Item ID: **TKS53R1133F**



**PRO35™**

**26" PRO35™ STACK FOAM TOOL KIT 418 PIECES RED**

**NEW**

**418**  
PIECES

FOAM  
SERIES

- 11** Drawer
- 3-Piece Cabinet Frame**
- Heavy Gauge Steel**
- 5-Step Phosphate-Free Rust Protection**
- 26" Wide Cabinet**
- 5" x 1-1/4" Castor Wheels with Brakes**
- 3 Step Ball Bearing Slides**
- Comfort Grip Handle**
- Combination Lock**





Drawer	Item ID	Description
	TST26R4	26" PRO35™ tool chest 4 drawers red
	TSW26R7	26" PRO35™ roller cabinet 7 drawers red
	TCF06	Fixing brackets for 26" 4-drawer tool chest
	TCA08	Paper roll holder for side handle
1/4	EMPTY	
2/4	EMPTY	
3/4	EMPTY	
4/4	TEDTX7	T-Handle Ball Point TX Key Set FOAM2
4/4	TEDHEX7	T-Handle Ball Point Hex Key Set FOAM2
1/7	TED1489	1/4" Socket Set 6 pt FOAM2
1/7	TED3836	3/8" Socket Set 6 pt FOAM2
1/7	TEXEXT13	Extension Bars Set FOAMX4
2/7	TED1227	1/2" Socket Set 12 pt FOAM2
2/7	TED441Q	Plier Set Vinyl Grip Q FOAM2
2/7	TEX1238	3/8" & 1/2" Torque Wrench Set FOAMX4
3/7	TED911N	Screwdriver Set Mixed FOAM2
3/7	TED909TXN	Screwdriver Set TX FOAM2
3/7	TEX915N	Screwdriver Set Flat & PH FOAMX4
4/7	TEDPC14	Punch & Chisel Set FOAM2
4/7	TEDSD14	Torque Screwdriver Set FOAM2
4/7	TEXPB4	Pry Bar Set Roll/Heel FOAMX4
5/7	TED8012	Combination Spanner Set Anti Slip FOAM2
5/7	TEDADJ4	Adjustable Wrench Set FOAM2
5/7	TEX2032	Combination Spanner Set FOAMX4
6/7	TED9121	1/2" Impact Socket Set ANSI FOAM2
6/7	TEDHT42	Ball Point Hex & TX Key Set FOAM2
6/7	TEXW05	Wheel Tool Set FOAMX4
7/7	EMPTY	









Item ID: **TKS26R418F**

**PRO35™**

**26" PRO35™ STACK FOAM TOOL KIT 528 PIECES RED**

**528**  
PIECES

**FOAM**  
SERIES

-  **12** Drawer
-  **3-Piece Cabinet Frame**
-  **Heavy Gauge Steel**
-  **5-Step Phosphate-Free Rust Protection**
-  **26" Wide Cabinet**
-  **5" x 1-1/4" Castor Wheels with Brakes**
-  **3 Step Ball Bearing Slides**
-  **Comfort Grip Handle**
-  **Combination Lock**





Drawer	Item ID	Description
	TST26R5F	26" PRO35™ deep tool chest 5 drawers red
	TSW26R7	26" PRO35™ roller cabinet 7 drawers red
	TCA08	Paper roll holder for side handle
1/5	TTESK86	1/4" & 3/8" Socket Set FOAM4X4
2/5	TTESK63	1/2" Socket Set 12 pt FOAM4X4
3/5	TTEISK73	3/8" & 1/2" Impact Socket Set FOAM4X4
4/5	TTEISK33	3/4" Impact Socket Set DIN FOAM4X4
5/5	TTESK32	3/4" Socket Set FOAM4X4
1/7	TTEX23N	Nut Driver & Hex/TX T-Handle Set FOAM4X4
2/7	TTEMB14Q	Plier Set Vinyl Grip Q FOAM4X4
3/7	TTEMD122N	Screwdriver Set Mixed FOAM4X4
4/7	TTEVG11	Power Grip Plier Set FOAM4X4
5/7	TTESP31	Combination Spanner Set FOAM4X4
6/7	TTESP37	Spanner Set FOAM4X4
7/7	EMPTY	

Item ID: **TKS26R528F**





**PRO35™**

**26" PRO35™ STACK FOAM TOOL KIT 702 PIECES RED**

**NEW**

**702**  
PIECES

FOAM  
SERIES

- 12** Drawer
- 3-Piece Cabinet Frame**
- Heavy Gauge Steel**
- 5-Step Phosphate-Free Rust Protection**
- 26" Wide Cabinet**
- 5" x 1-1/4" Castor Wheels with Brakes**
- 3 Step Ball Bearing Slides**
- Comfort Grip Handle**
- Combination Lock**





Drawer	Item ID	Description
	TST26R5F	26" PRO35™ deep tool chest 5 drawers red
	TSW26R7	26" PRO35™ roller cabinet 7 drawers red
	TCA08	Paper roll holder for side handle
1/5	TTEMD115N	Screwdriver Set Mixed FOAM4X4
2/5	TTEX18	General Tool Set FOAM4X4
3/5	TTEX219	General Service Tool Set FOAM4X4
4/5	TTEMB13Q	Plier Set Q FOAM4X4
5/5	EMPTY	
1/7	TTEX23N	Nut Driver & Hex/TX T-Handle Set FOAM4X4
2/7	TTESP31A	Combination Spanner Set FOAM4X4
3/7	TTESK67	1/4", 3/8" & 1/2" drive metric socket set
4/7	TTESK85	1/4", 3/8" & 1/2" Socket Set FOAM4X4
5/7	TTESK25	3/4" Socket & Spanner Set
6/7	TTEISK103	1/2" Impact Socket Set FOAM4X4
7/7	EMPTY	



Item ID: **TKS26R702F**





**PRO35™**

**NEW**

**37" PRO35™ ROLLER CABINET FOAM TOOL KIT 637 PIECES RED**

**637**  
PIECES

FOAM  
SERIES

- 7 Drawer
- 3-Piece Cabinet Frame
- Heavy Gauge Steel
- 5-Step Phosphate-Free Rust Protection
- 37" Wide Cabinet
- 5" x 2" Castor Wheels with Brakes
- 3 Step Ball Bearing Slides
- Comfort Grip Handle
- Combination Lock





Drawer	Item ID	Description
	TSW37R7	37" PRO35™ roller cabinet 7 drawers red
	TC-TB03	Work Top for 37" Cabinet
	TCA08	Paper roll holder for side handle
1/7	TTESK77	1/4", 3/8" & 1/2" Socket Set FOAM4X4
1/7	TEDHT42	Ball Point Hex & TX Key Set FOAM2
1/7	TEZ01	Storage Tray FOAMX2 3 Compartments
2/7	TTEX32	Spanner & File Set FOAM4X4
2/7	TEDDF7	Double Flex Wrench Set FOAM2
2/7	TEZ01	Storage Tray FOAMX2 3 Compartments
3/7	TTEMD122N	Screwdriver Set Mixed FOAM4X4
3/7	TEDV909N	Insulated Screwdriver Set Mixed FOAM2
3/7	TEZ01	Storage Tray FOAMX2 3 Compartments
4/7	TTEMB13Q	Plier Set Q FOAM4X4
4/7	TEDV440	Insulated Plier Set FOAM2
4/7	TEZ01	Storage Tray FOAMX2 3 Compartments
5/7	TTESK85	1/4", 3/8" & 1/2" Socket Set FOAM4X4
5/7	TEDSD14	Torque Screwdriver Set FOAM2
5/7	TEZ01	Storage Tray FOAMX2 3 Compartments
6/7	TTEPS12	General Tool Set FOAM4X4
6/7	TEAHR81	Rivet Gun Set FOAM1
6/7	TEABS50	Impact Bit Set FOAM1
6/7	TEZ01	Storage Tray FOAMX2 3 Compartments
7/7	EMPTY	



Item ID: **TKW37R637F**





**PRO35™**

**NEW**

**37" PRO35™ ROLLER CABINET FOAM TOOL KIT 521 PIECES RED**

**521**  
PIECES

**FOAM**  
SERIES

- 7** Drawer
- 3-Piece Cabinet Frame**
- Heavy Gauge Steel**
- 5-Step Phosphate-Free Rust Protection**
- 37" Wide Cabinet**
- 5" x 2" Castor Wheels with Brakes**
- 3 Step Ball Bearing Slides**
- Comfort Grip Handle**
- Combination Lock**





Drawer	Item ID	Description
	TSW37R7	37" PRO35™ roller cabinet 7 drawers red
	TCA08	Paper roll holder for side handle
1/7	TED911N	Screwdriver Set Mixed FOAM2
1/7	TEDTX7	T-Handle Ball Point TX Key Set FOAM2
1/7	TEDHEX7	T-Handle Ball Point Hex Key Set FOAM2
1/7	TEXMDTN	Power Through Screwdriver Set FOAMX4
1/7	TEZVG03	Power Grip Plier Set FOAMX2
2/7	TTESP31A	Combination Spanner Set FOAM4X4
2/7	TED1489	1/4" Socket Set 6 pt FOAM2
2/7	TEZSN06	Extractor and Nut Splitter Set FOAMX2
3/7	TTESK63	1/2" Socket Set 12 pt FOAM4X4
3/7	TED3836	3/8" Socket Set 6 pt FOAM2
3/7	TEZ01	Storage Tray FOAMX2 3 Compartments
4/7	TTESK85	1/4", 3/8" & 1/2" Socket Set FOAM4X4
4/7	TED441-TQ	Plier Set TPR Grip Q FOAM2
4/7	TEZ01	Storage Tray FOAMX2 3 Compartments
5/7	TTEISK33	3/4" Impact Socket Set DIN FOAM4X4
5/7	TED909TXN	Screwdriver Set TX FOAM2
5/7	TEZ01	Storage Tray FOAMX2 3 Compartments
6/7	TTESK25	3/4" Socket & Spanner Set
6/7	TEDADJ4	Adjustable Wrench Set FOAM2 4 Pieces
6/7	TEZ01	Storage Tray FOAMX2 3 Compartments
7/7	TTEISK73	3/8" & 1/2" Impact Socket Set FOAM4X4
7/7	TEDPC14	Punsch & Chisel Set FOAM2
7/7	TEZ01	Storage Tray FOAMX2 3 Compartments



Item ID: **TKW37R521F**







**PRO35™**

**NEW**

**26" PRO35™ ROLLER CABINET FOAM TOOL KIT 335 PIECES RED**

**335**  
PIECES

**FOAM**  
SERIES

- 7** Drawer
- 3-Piece Cabinet Frame**
- Heavy Gauge Steel**
- 5-Step Phosphate-Free Rust Protection**
- 26" Wide Cabinet**
- 5" x 1-1/4" Castor Wheels with Brakes**
- 3 Step Ball Bearing Slides**
- Comfort Grip Handle**
- Combination Lock**



Drawer	Item ID	Description
	TSW26R7	26" PRO35™ roller cabinet 7 drawers red
	TCA08	Paper roll holder for side handle
1/7	TTEMB13Q	Plier Set Q FOAM4X4
2/7	TTEMD98N	Screwdriver Set Mixed FOAM4X4
3/7	TTEPS12	General Tool Set FOAM4X4
4/7	TTESK85	1/4", 3/8" & 1/2" Socket Set FOAM4X4
5/7	TTESK77	1/4", 3/8" & 1/2" Socket Set FOAM4X4
6/7	TTEX17	General Tool Set FOAM4X4
7/7	TTEX32	Spanner & File Set FOAM4X4



Item ID: **TKW26R335F**





**PRO35™**

**NEW**

**26" PRO35™ ROLLER CABINET FOAM TOOL KIT 278 PIECES RED**

**278**  
PIECES

FOAM  
SERIES

- 7** Drawer
- 3-Piece Cabinet Frame**
- Heavy Gauge Steel**
- 5-Step Phosphate-Free Rust Protection**
- 26" Wide Cabinet**
- 5" x 1-1/4" Castor Wheels with Brakes**
- 3 Step Ball Bearing Slides**
- Comfort Grip Handle**
- Combination Lock**



Drawer	Item ID	Description
	TSW26R7	26" PRO35™ roller cabinet 7 drawers red
	TCA08	Paper roll holder for side handle
1/7	TTEX23N	Nut Driver & Hex/TX T-Handle Set FOAM4X4
2/7	TTEMMD122N	Screwdriver Set Mixed FOAM4X4
3/7	TTESK86	1/4" & 3/8" Socket Set FOAM4X4
4/7	TTEMB14Q	Plier Set Vinyl Grip Q FOAM4X4
5/7	TTESP31	Combination Spanner Set FOAM4X4
6/7	EMPTY	
7/7	EMPTY	



Item ID: **TKW26R278F**





**CLASSIC™**

**26" CLASSIC CABINET FOAM TOOL KIT 179 PIECES RED**

179  
PIECES

FOAM  
SERIES

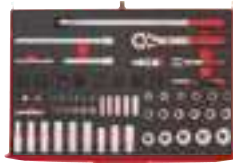

Drawer	Item ID	Description
	TCW707EV	26" CLASSIC Cabinet 7 Drawers Red
1/7	TTEPS25	General Tool Set FOAM4X4 25 Pieces
2/7	TTESK126	1/4" & 1/2" Socket Set 6 pt FOAM4X4 126 Pieces
3/7	TTESP28	General Tool Set FOAM4X4 28 Pieces
4/7	EMPTY	
5/7	EMPTY	
6/7	EMPTY	
7/7	EMPTY	



Item ID: **TCMME179**

**MECCA PRO™**

**MECCA PRO TC-9 FOAM TOOL KIT 118 PIECES**

118  
PIECES

FOAM  
SERIES



Combination Lock



Section	Item ID	Description
1/3	TEFMD54	Screwdriver, Hex Key & MM Tape FOAM3 54 Pieces
2/3	TEFMB7	General Tool Set Carpenters Hammer FOAM3 7 Pieces
3/3	TEFSK57	Spanner & Socket Set FOAM3 57 Pieces



Item ID: **SCEI**





# MECCA PRO™

## MECCA PRO TC-9 FOAM BP TOOL KIT 118 PIECES

118  
PIECES

FOAM  
SERIES



Combination Lock



Section	Item ID	Description
1/3	TEFMD54	Screwdriver, Hex Key & MM Tape FOAM3 54 Pieces
2/3	TEFMB7	General Tool Set Carpenters Hammer FOAM3 7 Pieces
3/3	TEFSK57	Spanner & Socket Set FOAM3 57 Pieces



Item ID: SCE2



# MECCA PRO™

NEW

## MECCA PRO TC-9 FOAM TOOL KIT 53 PIECES

56  
PIECES

FOAM  
SERIES



Combination Lock



Section	Item ID	Description
1/3	TEFXV11	Insulated Plier & Screwdriver Set FOAM3 11 Pieces
2/3	TEFSPV17	Insulated Spanner Set FOAM3 17 Pieces
3/3	TEFXV27	Insulated Torque Screwdriver Set FOAM3 27 Piece



Item ID: SCE3





# MECCA PRO™

**NEW**

## MECCA PRO TC-9 FOAM TOOL KIT 226 PIECES

226  
PIECES

FOAM  
SERIES



Combination Lock



# MECCA PRO™

**NEW**

## MECCA PRO TC-9 FOAM TOOL KIT 52 PIECES

52  
PIECES

FOAM  
SERIES



Combination Lock



Section	Item ID	Description
1/3	TED911N	Screwdriver Set Mixed FOAM2 11 Pieces
1/3	TEASD38	Torque Screwdriver Set FOAM1 38 Pieces
2/3	TED441-TQ	Plier Set TPR Grip Q FOAM2 5 Pieces
2/3	TEAHR81	Rivet Gun Set FOAM1 81 Pieces
3/3	TED8012	Combination Spanner Set Anti Slip FOAM2 12 Pieces
3/3	TEAMDQ78	Bits Driver Set FOAM1 78 Pieces

Section	Item ID	Description
1/3	TEFX07A	Electrician Tool Set FOAM3 7 Pieces
2/3	TEFSPV17	Insulated Spanner Set FOAM3 17 Pieces
3/3	TEFXV27	Insulated Torque Screwdriver Set FOAM3 27 Pieces



Item ID: **SCE4**



Item ID: **SCE5**







# MECCA PRO™

## MECCA PRO TC-6T FOAM TOOL KIT 112 PIECES

112  
PIECES

FOAM  
SERIES



Section	Item ID	Description
1/2	TEFMDI54	Screwdriver, Hex Key & MM/AF Tape FOAM3 54 Pieces
2/2	TEFSK57	Spanner & Socket Set FOAM3 57 Pieces



Item ID: **TC-6TE01**

# MECCA PRO™

## MECCA PRO TC-6T FOAM ELECTRICIAN TOOL KIT 29 PIECES

29  
PIECES

FOAM  
SERIES

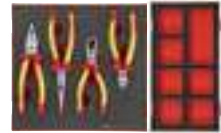
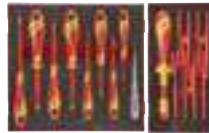

Section	Item ID	Description
1/2	TEDV909N	Insulated Screwdriver Set Mixed FOAM2
2/2	TEAVSD09	Insulated Torque Screwdriver Set FOAM1 9 Pieces
2/2	TEDV440	Insulated Plier Set FOAM2 4 Pieces
2/2	TEA01	Storage Tray FOAM1 7 Compartments



Item ID: **TC-6TE02**







# MECCA PRO™

NEW

## MECCA PRO TC-6T FOAM ELECTRICIAN TOOL KIT 37 PIECES

37  
PIECES

FOAM  
SERIES

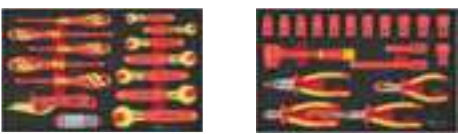

Section	Item ID	Description
1/2	TEFXV17	Insulated Screwdriver Set Mixed FOAM2
2/2	TEFSKV19	Insulated Socket & Pliers Set FOAM3 19 Pieces



Item ID: **TC-6TE03**

# MECCA PRO™

NEW

## MECCA PRO TC-6 FOAM ELECTRICIAN TOOL KIT 36 PIECES

36  
PIECES

FOAM  
SERIES

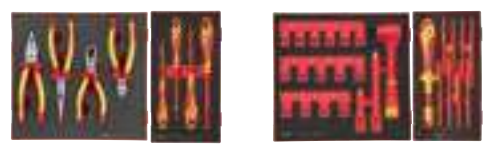

Section	Item ID	Description
1/2	TEDV440	Insulated Plier Set FOAM2 4 Pieces
1/2	TEAMDVO4N	Insulated Screwdriver Set Flat FOAM1 4 Pieces
2/2	TEDV3818	3/8" Insulated Socket Set FOAM2 18 Pieces
2/2	TEAVSD09	Insulated Torque Screwdriver Set FOAM1 9 Pieces



Item ID: **TC-6TE04**





# MECCA PRO™

NEW

## MECCA PRO TC-6 FOAM ELECTRICIAN TOOL KIT 29 PIECES

29  
PIECES

FOAM  
SERIES



Section	Item ID	Description
1/2	TEFXV11	Insulated Plier & Screwdriver Set FOAM3 11 Pieces
2/2	TEFSPV17	Insulated Spanner Set FOAM3 17 Pieces



Item ID: **TC-6TE05**



# MECCA PRO™

NEW

## MECCA PRO TC-6 FOAM ELECTRICIAN TOOL KIT 39 PIECES

39  
PIECES

FOAM  
SERIES



Section	Item ID	Description
1/2	TEFXV11	Insulated Plier & Screwdriver Set FOAM3 11 Pieces
2/2	TEFXV27	Insulated Torque Screwdriver Set FOAM3 27 Pieces



Item ID: **TC-6TE06**



# FOAM SERIES TOOL TRAYS

## A FLEXIBLE TOOL CONTROL SYSTEM WITH OVER 240 TOOL SETS

The Foam Series offers the ultimate tool organisation. Each tool has its own place with its description imprinted in the 3-coloured foam. The contrast colours makes it easy to identify tools and see when a tool is missing. The high quality foam stays soft and flexible even in cold environments and gives the tool kit a premium look.

### 1 CHOOSE YOUR STORAGE

Storages for all needs.



### 2 CHOOSE YOUR TOOL SETS

Your kit. Your way.



### 3 ORGANISE YOUR KIT

Optimise your workflow.

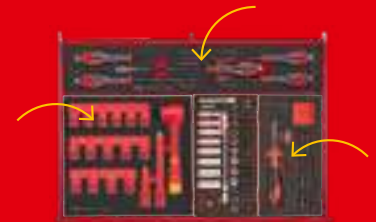



# FOAM SERIES

## SIZE



Portable Service case



26" Top & Middle box drawer



26" cabinet drawer



37" cabinet drawer



1

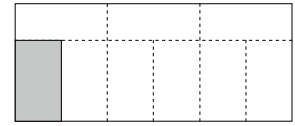
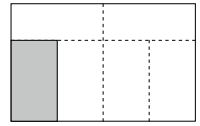
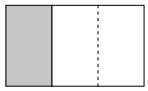

2

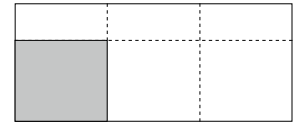
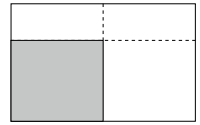

3

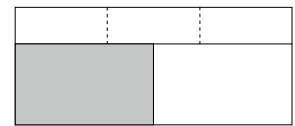
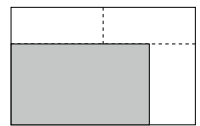

x4

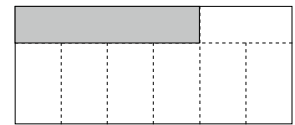
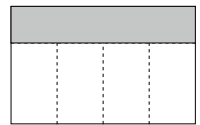
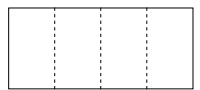
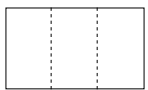

x2

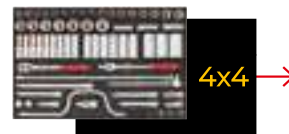
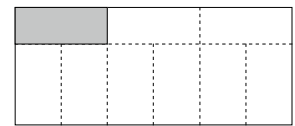
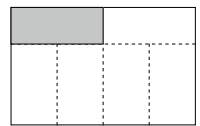
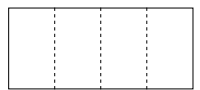
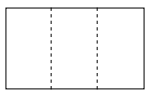

4x4

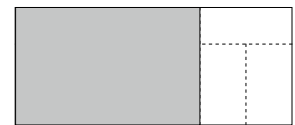
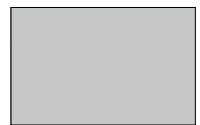
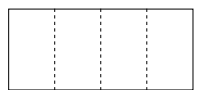
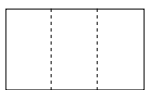



**IMPACT BIT SET WITH BELT CLIP MIXED 12 PIECES**



**CONTENTS**

- » 1/4" PZ Impact Bits 30mm  
PZ1, PZ2
- » 1/4" PH G Impact Bits 30mm PH2G
- » 1/4" Hex Impact Bits 30mm  
3, 4, 5
- » 1/4" Magnetic Impact Bit Holder 60mm
- » 1/4" TX Impact Bits 30mm  
TX20, TX25, TX30
- » 1/4" ROB Impact Bits 30mm  
1, 2

Item ID: **TJ1413**



**IMPACT BIT SET WITH BELT CLIP TX 12 PIECES**

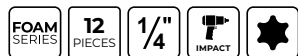

**CONTENTS**

- » 1/4" TX Impact Bits 30mm  
TX10, TX15, TX20, TX25, TX27, TX30, TX40
- » 1/4" Magnetic Impact Bit Holder 60mm

Item ID: **TJ1414**



**IMPACT BIT SET CONSTRUCTION WITH BELT CLIP MIXED 12 PIECES**



**CONTENTS**

- » 1/4" PZ Impact Bits 30mm  
PZ1, PZ2, PZ3
- » 1/4" TX Impact Bits 30mm  
TX10, TX20, TX25, TX30
- » 1/4" PH G Impact Bits 30mm PH2G
- » 1/4" Magnetic Impact Bit Holder 60mm
- » 1/4" ROB Impact Bits 30mm  
1, 2
- » 1/4" PH Impact Bits 30mm PH2 1 pc

Item ID: **TJ1412**



**STORAGE TRAY FOAM1 7 COMPARTMENTS**



Item ID: **TEA01**

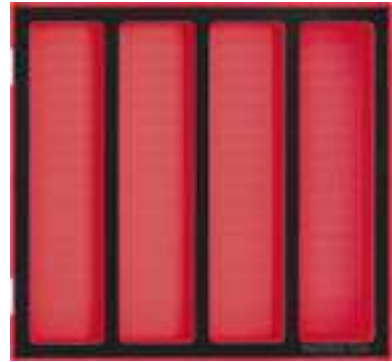

**STORAGE TRAY FOAM2 4 COMPARTMENTS**



Item ID: **TED00**



**STORAGE TRAY FOAM1 2 COMPARTMENTS**



Item ID: **TEA02**

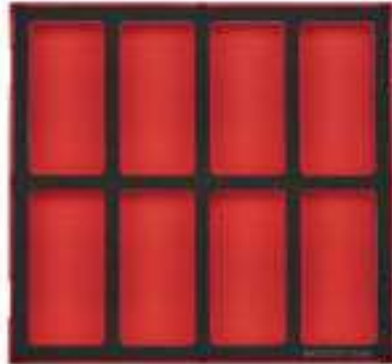

**STORAGE TRAY FOAM2 8 COMPARTMENTS**



Item ID: **TED01**







**STORAGE TRAY FOAMX4 4 COMPARTMENTS**



Item ID: **TEX02**



**STORAGE TRAY FOAMX2 3 COMPARTMENTS**



Item ID: **TEZ01**



**GENERAL TOOL SET FOAM3 7 PIECES**



**CONTENTS**

- » Adjustable Wrench Wide Jaw 200mm
- » Side Cutting Plier TPR Grip 160mm
- » Quick Set Water Pump Plier HRC60 250mm
- » Long Nose Plier TPR Grip 205mm
- » Utility Knife
- » Carpenters Claw Hammer 16oz
- » Tin Snip High Leverage Straight

Item ID: **TEFMB7**



**GENERAL TOOL SET BP FOAM3 7 PIECES**



**CONTENTS**

- » Adjustable Wrench Wide Jaw 200mm
- » Side Cutting Plier TPR Grip 160mm
- » Quick Set Water Pump Plier HRC60 250mm
- » Long Nose Plier TPR Grip 205mm
- » Ball Pein Hammer 16oz
- » Utility Knife
- » Tin Snip High Leverage Straight

Item ID: **TEFMBP7**





**GENERAL TOOL SET E FOAM3 7 PIECES**



**CONTENTS**

- » Engineers Hammer 500g
- » Adjustable Wrench Wide Jaw 200mm
- » Side Cutting Plier TPR Grip 160mm
- » Quick Set Water Pump Plier HRC60 250mm
- » Long Nose Plier TPR Grip 205mm
- » Utility Knife
- » Tin Snip High Leverage Straight

Item ID: **TEFMBP7E**



**GENERAL TOOL SET FOAM4X4 25 PIECES**



**CONTENTS**

- » Engineers Hammer 500g
- » Parallel Pin Punch Set 6 Pieces
- » Long Nose Plier 165mm
- » Water Pump Plier 240mm
- » Snap Off Knife 18mm Plastic Housing
- » Replacement Snap Off Blades 18mm 10 pcs
- » Soft Face Hammer
- » Measuring Tape Metric/Inch 3m
- » Hacksaw 24TPI Metal
- » Heavy Duty Combination Plier 185mm
- » Heavy Duty Side Cutting Plier 160mm

Item ID: **TTEPS25**





**GENERAL TOOL SET BP FOAM3 6 PIECES**



**CONTENTS**

- » Adjustable Wrench Wide Jaw 200mm
- » Snap Off Knife Knife 9mm Metal Casing
- » Quick Set Water Pump Plier HRC60 250mm
- » Ball Pein Hammer 16oz
- » Utility Knife
- » Hacksaw Blade Holder 24TPI Metal

Item ID: **TEFX06**



**PLUMBER TOOL SET FOAM3 7 PIECES**



**CONTENTS**

- » Adjustable Wrench Wide Jaw 200mm
- » Torpedo Spirit Level Aluminium 230mm
- » Deburring Tool
- » Pipe Cutter 3 - 32mm
- » Quick Set Water Pump Plier HRC60 250mm
- » Vernier Caliper 0-150mm
- » Hacksaw Blade Holder 24TPI Metal

Item ID: **TEFX07**



**GENERAL TOOL SET E FOAM3 6 PIECES**



**CONTENTS**

- » Engineers Hammer 500g
- » Adjustable Wrench Wide Jaw 200mm
- » Snap Off Knife Knife 9mm Metal Casing
- » Quick Set Water Pump Plier HRC60 250mm
- » Utility Knife
- » Hacksaw Blade Holder 24TPI Metal

Item ID: **TEFX06E**



**ELECTRICIAN TOOL SET FOAM3 7 PIECES**



**CONTENTS**

- » Insulated Long Nose Plier 215mm
- » Scissors 5-1/2"
- » Voltage Tester
- » Ratcheting Crimping Plier
- » Ratcheting Wire Stripping Plier
- » Cable Tie Gun
- » Insulated Side Cutting Plier 160mm

Item ID: **TEFX07A**





**GENERAL TOOL SET FOAM4X4 15 PIECES**



**CONTENTS**

- » Engineers Hammer 800g
- » Heavy Duty Combination Plier TPR Grip 200mm
- » Parallel Pin Punch Set 6 Pieces
- » Measuring Tape Metric 3m
- » Hacksaw Ergonomic Handle 24TPI Metal
- » Water Pump Plier TPR Grip 250mm
- » Heavy Duty Side Cutting Plier TPR Grip 200mm
- » Long Nose Plier TPR Grip 205mm
- » Flat Cold Chisel 250 x 25mm
- » Folding Utility Knife

Item ID: **TTEPS15**



**GENERAL TOOL SET FOAM4X4 12 PIECES**



**CONTENTS**

- » Engineers Hammer 800g
- » Parallel Pin Punch Set 6 Pieces
- » Steel Rule mm/AF 200mm
- » Centre Punch 5mm
- » Flat Cold Chisel
- » 18, 25
- » Soft Face Hammer
- » Measuring Tape Metric/Inch 3m
- » Adjustable Wrench TPR Grip 150mm
- » Adjustable Wrench TPR Grip 250mm
- » Hacksaw 24TPI Metal
- » Utility Knife

Item ID: **TTEPS12**





NEW



**GENERAL TOOL SET 18 PIECES**

FOAM SERIES 6x6 18 PIECES

CONTENTS

- » General tool set 18 pieces
  - » Adjustable Wrench Wide Jaw 150 mm
  - » Adjustable Wrench Wide Jaw 250 mm
  - » Hacksaw Ergonomic Handle 24TPI Metal
  - » Utility Knife
  - » Flat Cold Chisel
    - » 18, 25
  - » Centre Punch 5 mm
  - » Ball Pein Hammer 24oz
  - » Soft Face Hammer
  - » Measuring Tape Metric/Inch 3m
  - » Parallel Pin Punch Set 6 Pieces
    - » Parallel Pin Punch
      - » 3, 4, 5, 6, 7, 8
  - » Scriber
  - » Steel Rule mm/AF 200 mm

Item ID: **TTEX18**



NEW



**GENERAL SERVICE TOOL SET 219 PIECES**

FOAM SERIES 6x6 219 PIECES 1/4 3/8 1/2

CONTENTS

- » General service tool set 219 pieces
  - » 1/2" Torque Wrench 40 - 210Nm
  - » 1/4" Mini Palm Ratchet 45 Teeth
  - » 3/8" Torque Wrench 20 - 110Nm
  - » Drill Bits Fully Ground
    - » 1, 1.5, 2, 2.5, 3, 3.3, 3.5, 4, 4.2, 4.5, 5, 5.5, 6, 6.5, 6.8, 7, 7.5, 8, 8.5, 9, 9.5, 10, 10.5
  - » Nutsert Gun M3/M4/M5/M6
  - » Hand Rivet Gun Aluminium Alloy 2.4/3.2/4.0/4.8 mm
  - » 1/4" Extension Bar 100 mm
  - » 1/4" Die Chuck M3 - M12
  - » 1/4" Tap Chuck
    - » M3 - M8, M5 - M12
  - » Reducing Adaptor 3/8"F - 1/4"M
  - » Hex Mini Screwdriver 2.5
  - » Pitch Gauge
  - » Screw Extractor
    - » 1, 2, 3, 4, 5
  - » Die
    - » 0, 5, 7, 8, 25
  - » Tap
    - » 0, 5 ( x 2), 7, 8, 25, 75
  - » Screw Extractor Set With Belt Clip 5 Pieces
    - » Screw Extractor
      - » 1, 2, 3, 4, 5

Item ID: **TTEX219**





**GENERAL TOOL SET FOAM4X4 37 PIECES**



**CONTENTS**

- » LED Torch With Pocket Clip
- » T Handle Ball Point Hex Key Metric  
2.5, 3, 4, 5, 6, 7, 8
- » Hex Key Metric 7mm
- » Telescopic Magnifying Glass
- » Ball Point Hex Key Set 9 Pieces
- » Folding Key Set Mixed 8 Pieces
- » Telescopic Inspection Mirror
- » Telescopic Pick Up Tool 760mm
- » 1/2" Torque Wrench 40 - 210Nm
- » TX Key Set 9 Pieces

Item ID: **TTEX17**

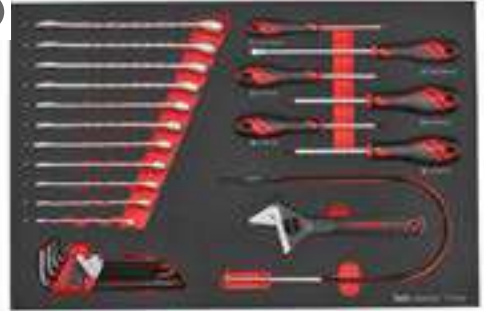

**GENERAL TOOL SET FOAM4X4 28 PIECES**



**CONTENTS**

- » Combination Spanner Metric  
8, 10, 11, 12, 13, 14, 15, 16, 17, 18, 19
- » PH Screwdriver  
PH1, PH2
- » Adjustable Wrench Wide Jaw 200mm
- » PZ Screwdriver  
PZ1, PZ2
- » Claw Pick Up Tool
- » Ball Point Hex Key Set 9 Pieces
- » Flat Screwdriver  
0.6 x 3.5, 1.0 x 5.5

Item ID: **TTESP28**







**NEW**



**MIXED DRIVER AND BITS SET FOAM4X4 115 PIECES**



**CONTENTS**

- » Mixed driver and bits set FOAM4X4 115 pieces
- » 1/4" Mini Bits Ratchet
- » 1/4" Flat Bits 25mm
- » 0.6 x 3.5, 0.6 x 4.5, 0.8 x 4.0, 0.8 x 5.5, 1.0 x 5.5, 1.2 x 6.5, 1.6 x 8.0
- » 1/4" Flat Bits 50mm
- » 0.6 x 3.5, 0.8 x 4.0, 0.8 x 5.5, 1.0 x 5.5, 1.2 x 6.5
- » 1/4" PH G Bits 25 mm PH2G x10
- » 1/4" Hex Bits 25mm
- » 2, 3, 4, 5, 6, 8
- » 1/4" Hex Bits 50mm
- » 4, 5, 6, 8
- » Flat Screwdriver
- » 0.5 x 2.5, 0.5 x 3.0, 0.6 x 3.5, 0.8 x 4.0, 1.0 x 5.5 ( x 2 ), 1.2 x 6.5 ( x 2 ), 1.2 x 8.0, 1.6 x 10.0
- » PH Screwdriver PH0, PH1, PH2, PH3, PH4
- » PZ Screwdriver PZ0, PZ1 ( x 2 ), PZ2, PZ3
- » 1/4" Stubby Bits Driver
- » 1/4" Quick Chuck Bits Driver 217 mm
- » 1/4" T Handle Quick Chuck Bits Driver
- » 1/4" PH Bits 25mm
- » PH1, PH2, PH3
- » 1/4" PH Bits 50mm
- » PH1, PH2, PH3
- » 1/4" PZ Bits 25mm
- » PZ1, PZ2, PZ3
- » 1/4" PZ Bits 50mm
- » PZ1, PZ2, PZ3
- » 1/4" Ratchet Head Hex/Square Drive
- » 1/4" ROB Bits 25mm
- » 1, 2, 3
- » 1/4" TPX Bits 25mm
- » TPX10, TPX15, TPX20, TPX25, TPX27, TPX30, TPX40
- » 1/4" TX Bits 25mm
- » TX6, TX7, TX8, TX9, TX10, TX15, TX20, TX25, TX27, TX30, TX40
- » 1/4" TX Bits 50mm
- » TX8, TX10, TX15, TX20, TX25, TX27, TX30

Item ID: **TTEMDD115N**



**NEW**



**FLEX HANDLE SET FOAMX4 3 PIECES**



**CONTENTS**

- » 1/4" Flex Handle 200 mm
- » 3/8" Flex Handle 300 mm
- » 1/2" Flex Handle 400 mm

Item ID: **TEXBR03**



**NEW**



**LONG ARM RATCHET FLEX HEAD SET FOAMX4 3 PIECES**



**CONTENTS**

- » 1/4" Long Ratchet Flexible Head 43 Teeth 200mm
- » 3/8" Long Ratchet Flexible Head 41 Teeth 300mm
- » 1/2" Long Ratchet Flexible Head 45 Teeth 400mm

Item ID: **TEXRF03**



**NEW****LONG ARM RATCHET SET FOAMX4 3 PIECES****CONTENTS**

- » 1/4" Ratchet Long Arm 43 Teeth 200mm
- » 3/8" Ratchet Long Arm 41 Teeth 300mm
- » 1/2" Ratchet Long Arm 45 Teeth 400mm

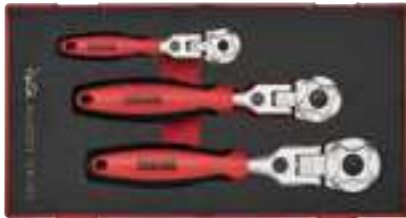
Item ID: **TEXRL03****1/4", 3/8" & 1/2" RATCHET FLEX HEAD SET FOAM1 3 PIECES****CONTENTS**

- » 3/8" Ratchet Flexible Head 72 Teeth
- » 1/4" Ratchet Flexible Head 72 Teeth
- » 1/2" Ratchet Flexible Head 72 Teeth

Item ID: **TEA7203****1/4" SOCKET & BITS SET FOAM1 87 PIECES****CONTENTS**

- » Hex Socket Adaptor 1/4" Hex - 1/4" 30mm
- » 1/4" TX Bits 25mm
  - » TX6, TX7, TX8, TX9, TX10, TX15, TX20, TX25, TX27, TX30, TX40
- » 1/4" PH Bits 25mm
  - » PH1, PH2, PH3
- » 1/4" Socket 6 pt Metric
  - » 5.5, 6, 7, 8, 9, 10, 11, 12, 13
- » 1/4" Socket 6 pt AF
  - » 1/4, 3/8, 5/16
- » 1/4" TPX Bits 25mm
  - » TPX10, TPX15, TPX20, TPX25, TPX27, TPX30, TPX40
- » 1/4" Hex Bits 25mm
  - » 2, 3, 4, 5, 6, 8
- » 1/4" Gearless Palm Ratchet
- » 1/4" PH G Bits 25mm PH2G
- » 1/4" Deep Socket 6 pt Metric
  - » 6, 7, 8, 9, 10, 11, 12, 13
- » 1/4" ROB Bits 25mm
  - » 1, 2, 3
- » 1/4" Flat Bits 25mm
  - » 0.6 x 3.5, 0.6 x 4.5, 0.8 x 4.0, 0.8 x 5.5, 1.0 x 5.5, 1.2 x 6.5, 1.6 x 8.0
- » 1/4" PZ Bits 25mm
  - » PZ1, PZ2, PZ3
- » 1/4" Extension Bar 75mm
- » Bi-flex Wrench 1/4" Hex x 1/4"

Item ID: **TEA1487**



**1/4" SOCKET SET 6 PT FOAM2 89 PIECES**



**CONTENTS**

- » 1/4" TX Bits 25mm
- » TX8, TX10, TX15, TX20, TX25, TX27, TX30, TX40, TX45
- » 1/4" PH Bits 25mm
- » PH0, PH1, PH2, PH3 (x2)
- » 1/4" Ratchet 72 Teeth
- » 1/4" Socket 6 pt Metric
- » 4, 5, 5.5, 6, 7, 8, 9, 10, 11, 12, 13
- » 1/4" TX Bit Socket
- » 10, 15, 20, 25, 27, 30, 40
- » 1/4" PH Bit Socket
- » PH0, PH1, PH2, PH3
- » Reducing Adaptor 3/8"F - 1/4"M
- » 1/4" TPX Bits 25mm
- » TPX10, TPX15, TPX20, TPX25, TPX27, TPX30, TPX40
- » 1/4" Extension Bar 50mm
- » 1/4" Extension Bar 100mm
- » 1/4" Hex Bits 25mm
- » 3, 4, 5, 6, 8, 10
- » 1/4" PZ Bit Socket
- » PZ1, PZ2, PZ3
- » 1/4" Deep Socket 6 pt Metric
- » 4, 5, 5.5, 6, 7, 8, 9, 10, 12, 13
- » 1/4" Flat Bits 25mm
- » 0.8 x 4.0, 0.8 x 5.5, 3, 7
- » 1/4" Flat Bit Socket
- » 4, 5.5, 7
- » 1/4" PZ Bits 25mm
- » PZ0, PZ1, PZ2, PZ3
- » 1/4" Universal Joint
- » 1/4" Spinner Handle
- » 1/4" Bit Adaptor Hex Bit Coupler
- » Hex Socket Adaptor 1/4" Hex - 1/4" 25mm

Item ID: **TED1489**



**3/8" SOCKET SET 6 PT FOAM2 36 PIECES**

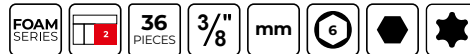

**CONTENTS**

- » Reducing Adaptor 1/2"F - 3/8"M
- » 3/8" Hex Bit Socket Metric
- » 3, 4, 5, 5.5, 6, 7, 8, 10, 12
- » 3/8" Socket 6 pt Metric
- » 8, 9, 10, 11, 12, 13, 14, 15, 16, 17, 18, 19, 22
- » 3/8" TX Bit Socket
- » TX10, TX15, TX20, TX25, TX27, TX30, TX40, TX45, TX50
- » 3/8" Wobble Extension Bar 75mm
- » 3/8" Rotating Spinner Handle
- » 3/8" Universal Joint
- » 3/8" Ratchet 72 Teeth

Item ID: **TED3836**

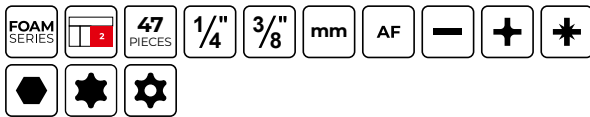

**NEW****1/4" & 3/8" BIT SOCKET SET FOAM2 47 PIECES****CONTENTS**

- » 1/4" PH Bit Socket
  - » PH0, PH1, PH2, PH3
- » Reducing Adaptor 3/8"F - 1/4"M
- » Step Up Adaptor 1/4"F - 3/8"M
- » 3/8" Hex Bit Socket AF
  - » 1/4, 1/8, 3/16, 3/8, 5/16, 5/32, 7/32
- » 3/8" Hex Bit Socket Metric
  - » 3, 4, 5, 5.5, 6, 7, 8, 10, 12
- » 3/8" TX Bit Socket
  - » TX10, TX15, TX20, TX25, TX27, TX30, TX40, TX45, TX50
- » 1/4" PZ Bit Socket
  - » PZ1, PZ2, PZ3
- » 3/8" TPX Bit Socket
  - » TPX10, TPX15, TPX20, TPX25, TPX27, TPX30, TPX40, TPX45, TPX50
- » 1/4" Flat Bit Socket
  - » 4, 5.5, 7
- » 3/8" Extension Bar 75mm

Item ID: **TEDBS47****1/2" SOCKET SET 12 PT FOAM2 27 PIECES****CONTENTS**

- » 1/2" Socket 12 pt Metric
  - » 10, 11, 12, 13, 14, 15, 16, 17, 18, 19, 22, 24
- » 1/2" Deep Socket 12 pt Metric
  - » 10, 11, 12, 13, 14, 15, 16, 17, 18, 19
- » 1/2" Universal Joint
- » 1/2" Ratchet 72 Teeth
- » Step Up Adaptor 3/8"F - 1/2"M
- » 1/2" Extension Bar 63.5mm
- » 1/2" Extension Bar 150mm

Item ID: **TED1227****NEW****1/2" LONG HEX & TX BIT SOCKET SET FOAM2 17 PIECES****CONTENTS**

- » 1/2" Long TX Bit Socket
  - » TX20, TX25, TX27, TX30, TX40, TX45, TX50, TX55, TX60
- » 1/2" Long Hex Bit Socket Metric
  - » 5, 6, 7, 8, 10, 12, 14, 17

Item ID: **TEDLBS17**



**1/4" & 1/2" SOCKET SET FOAM3 44 PIECES**

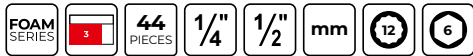

**CONTENTS**

- » 1/2" Ratchet 72 Teeth
- » 1/4" Ratchet 72 Teeth
- » 1/2" Wobble Extension Bar 75mm
- » 1/2" Wobble Extension Bar 150mm
- » 1/2" Universal Joint
- » 1/4" Universal Joint
- » 1/2" Socket 12 pt Metric  
10, 11, 12, 13, 14, 15, 16, 17, 18, 19, 21, 22, 24, 27, 30, 32
- » 1/4" Spinner Handle
- » 1/4" Extension Bar 50mm
- » 1/4" Extension Bar 75mm
- » 1/4" Deep Socket 6 pt Metric  
6, 7, 8, 9, 10, 11, 12, 13
- » 1/4" Socket 12 pt Metric  
4, 5, 5.5, 6, 7, 8, 9, 10, 11, 12, 13

Item ID: **TEFSK44**



**SPANNER & SOCKET SET FOAM3 57 PIECES**

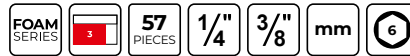

**CONTENTS**

- » Hex Socket Adaptor 1/4" Hex - 1/4" 30mm
- » 1/4" Ratchet 72 Teeth
- » 3/8" Ratchet 72 Teeth
- » 1/4" Socket 6 pt Metric  
4, 5, 5.5, 6, 7, 8, 10, 11, 12, 13
- » Combination Spanner Metric  
8, 9, 10, 11, 12, 13, 14, 15, 16, 17, 18, 19
- » Reducing Adaptor 3/8"F - 1/4"M
- » Reducing Adaptor 1/2"F - 3/8"M
- » 1/4" Extension Bar 50mm
- » 1/4" Extension Bar 75mm
- » 3/8" Socket 6 pt Metric  
8, 9, 10, 11, 12, 13, 14, 15, 16, 17, 18, 19, 21, 22
- » 1/4" Deep Socket 6 pt Metric  
6, 7, 8, 10, 12, 13
- » 1/4" Universal Joint
- » 3/8" Universal Joint
- » 3/8" Bit Adaptor Hex bit coupler 1/4" Hex
- » 3/8" Spark Plug Socket  
16, 21
- » 3/8" Extension Bar 150mm
- » 3/8" Extension Bar 75mm
- » 1/4" Bit Adaptor Hex Bit Coupler

Item ID: **TEFSK57**



**EXTENSION BARS SET FOAMX4 13 PIECES****CONTENTS**

- » Reducing Adaptor 3/8"F - 1/4"M
- » Hex Mini Screwdriver  
2, 2.5
- » 1/2" Universal Joint
- » 1/4" Universal Joint
- » 3/8" Universal Joint
- » 3/8" Wobble Extension Bar 75mm
- » 1/2" Extension Bar 500mm
- » 1/4" Extension Bar 150mm
- » 1/4" Extension Bar 305mm
- » T Bar Handle Grip
- » 3/8" Extension Bar 500mm
- » 1/2" Wobble Extension Bar 75mm

Item ID: **TEXEXT13****3/4" RATCHET & ACCESSORIES SET FOAMX4 3 PIECES****CONTENTS**

- » 3/4" Extension Bar 400mm
- » 3/4" Sliding T Bar
- » 3/4" Ratchet Heavy Duty 72 Teeth

Item ID: **TEX3403****3/4" SOCKET SET 6 PT FOAMX4 10 PIECES****CONTENTS**

- » 3/4" Socket 6 pt Metric
- » 22, 24, 27, 30, 32, 36, 38, 41, 46, 50

Item ID: **TEX3410**





**1/2" SOCKET SET 12 PT FOAM4X4 63 PIECES**

FOAM SERIES
4x4
63 PIECES
1/2"
mm
12

**CONTENTS**

- » 1/2" Deep Socket 12 pt Metric
- » 10, 11, 12, 13, 14, 15, 16, 17, 18, 19, 20, 21, 22, 24, 27, 30, 32, 36
- » 1/2" Socket 12 pt Metric
- » 8, 9, 10, 11, 12, 13, 14, 15, 16, 17, 18, 19, 20, 21, 22, 24, 25, 26, 27, 28, 29, 30, 32, 34
- » 1/2" Spark Plug Socket
- » 16, 18, 21
- » Reducing Adaptor 1/2"F - 3/8"M
- » 1/2" Universal Joint
- » 1/2" Ratchet 72 Teeth
- » 1/2" Bit Adaptor 5/16" Hex
- » 1/2" Bit Adaptor 12mm
- » 1/2" Bit Adaptor 10mm
- » 1/2" Extension Bar 500mm
- » 1/2" Extension Bar 125mm
- » 1/2" Extension Bar 63.5mm
- » 1/2" Extension Bar 150mm
- » Step Up Adaptor 1/2"F - 3/4"M
- » 1/2" Wobble Extension Bar 150mm
- » 1/2" Wobble Extension Bar 255mm
- » 1/2" Wobble Extension Bar 75mm
- » 1/2" Flex Head Adaptor
- » 1/2" Speed Brace
- » 1/2" Sliding T Bar
- » 1/2" Flex Handle 265mm

Item ID: **TTESK63**



**NEW**



**3/4" SOCKET & SPANNER SET 25 PIECES**

FOAM SERIES
4x4
25 PIECES
3/4"
mm
6

**CONTENTS**

- » Combination Spanner Metric
- » 34, 36, 38
- » 3/4" Extension Bar 200mm
- » 3/4" Flex Handle 480mm
- » 3/4" Ratchet Heavy Duty 72 Teeth
- » 3/4" Socket 6 pt Metric
- » 19, 21, 22, 24, 26, 27, 30, 32, 33, 34, 36, 38, 41, 46, 50
- » 3/4" Hex Bit Socket Metric
- » 14, 17, 19, 22

Item ID: **TTESK25**





### 3/4" SOCKET SET FOAM4X4 32 PIECES

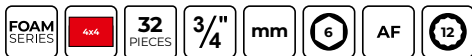

#### CONTENTS

- » 3/4" Socket 6 pt Metric  
19, 21, 22, 24, 27, 30, 32, 33, 34, 36, 38, 41, 46, 50
- » 3/4" Socket 12 pt AF  
1, 1-1/16, 1-1/2, 1-1/4, 1-1/8, 1-3/16, 1-3/4, 1-3/8, 1-5/16, 1-5/8, 1-7/16, 1-7/8, 15/16, 7/8
- » 3/4" Flex Handle Safety Lock 480mm
- » 3/4" Extension Bar Safety Lock 400mm
- » 3/4" Sliding T Bar Safety Lock
- » 3/4" Ratchet Heavy Duty 72 Teeth

Item ID: **TTESK32**

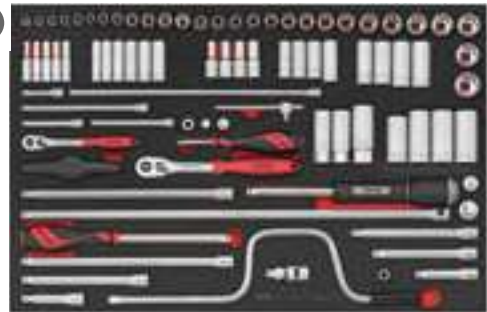

### 1/4" & 3/8" SOCKET SET FOAM4X4 86 PIECES

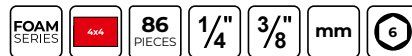

#### CONTENTS

- » 1/4" Ratchet 72 Teeth
- » 3/8" Ratchet 72 Teeth
- » 1/4" Socket 6 pt Metric  
4, 4.5, 5, 5.5, 6, 7, 8, 9, 10, 11, 12, 13
- » 3/8" Extension Bar 125mm
- » 3/8" Extension Bar 254mm
- » 3/8" Extension Bar 150mm
- » 3/8" Extension Bar 75mm
- » 3/8" Extension Bar 500mm
- » Reducing Adaptor 3/8"F - 1/4"M
- » Step Up Adaptor 1/4"F - 3/8"M
- » Step Up Adaptor 3/8"F - 1/2"M
- » 3/8" Socket 6 pt Metric  
7, 8, 9, 10, 11, 12, 13, 14, 15, 16, 17, 18, 19, 20, 21, 22
- » 1/4" Extension Bar 50mm
- » 1/4" Extension Bar 150mm
- » 1/4" Extension Bar 75mm
- » 1/4" Extension Bar 100mm
- » 1/4" Extension Bar 305mm
- » 3/8" Deep Socket 6 pt Metric  
7, 8, 9, 10, 11, 12, 13, 14, 15, 16, 17, 18, 19, 20, 21, 22
- » 1/4" Deep Socket 6 pt Metric  
4, 5, 5.5, 6, 7, 8, 9, 10, 11, 12, 13
- » 3/8" Wobble Extension Bar 75mm
- » 3/8" Wobble Extension Bar 255mm
- » 3/8" Wobble Extension Bar 150mm
- » 3/8" Speed Brace
- » 3/8" Rotating Spinner Handle
- » 1/4" Universal Joint
- » 3/8" Universal Joint
- » 3/8" Bit Adaptor Hex bit coupler 1/4" Hex
- » 3/8" Spinner Handle
- » 1/4" Spinner Handle
- » 3/8" Spark Plug Socket  
16, 18, 21
- » 1/4" Bit Adaptor Hex Bit Coupler
- » 1/4" Sliding T Bar

Item ID: **TTESK86**





**1/4" & 1/2" SOCKET SET 6 PT FOAM4X4 126 PIECES**

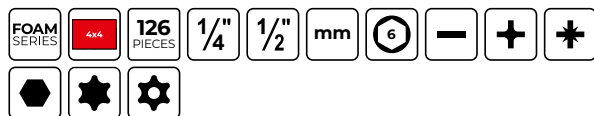

**CONTENTS**

- » 1/4" TX Bits 25mm
- » TX6, TX7, TX8, TX9, TX10, TX15, TX20, TX25, TX27, TX30, TX40
- » 1/4" PH Bits 25mm
- » PH1, PH2, PH3
- » 1/4" Socket 6 pt Metric
- » 4, 4.5, 5, 5.5, 6, 7, 8, 9, 10, 11, 12, 13
- » 1/4" TPX Bits 25mm
- » TPX10, TPX15, TPX20, TPX25, TPX27, TPX30, TPX40
- » 1/2" Deep Socket 12 pt Metric
- » 10, 13, 16, 17, 18, 19
- » 1/2" Spark Plug Socket
- » 16, 18, 21
- » 1/4" Hex Bits 25mm
- » 2, 3, 4, 5, 6, 8
- » 1/2" Universal Joint
- » 1/4" Universal Joint
- » 1/2" Extension Bar 255mm
- » 1/2" Extension Bar 125mm
- » 1/2" Socket 6 pt Metric
- » 10, 11, 12, 13, 14, 15, 16, 17, 18, 19, 20, 21, 24, 27, 30, 32, 34
- » 1/4" PH G Bits 25mm PH2G 10 pcs
- » 1/4" ROB Bits 25mm
- » 1, 2, 3
- » 1/2" Ratchet FRP 45 Teeth
- » 1/4" Flat Bits 25mm
- » 0.6 x 3.5, 0.6 x 4.5, 0.8 x 4.0, 0.8 x 5.5, 1.0 x 5.5, 1.2 x 6.5, 1.6 x 8.0
- » 1/4" PZ Bits 25mm
- » PZ1, PZ2, PZ3
- » 1/4" Deep Socket 6 pt Metric
- » 7, 8, 10, 11, 13
- » 1/4" Spinner Handle
- » 1/4" Mini Bits Ratchet
- » 1/4" Extension Bar 100mm
- » 1/4" Ratchet FRP 45 Teeth
- » 1/4" Bit Adaptor Hex Bit Coupler
- » 1/2" Breaker Bar 450 mm DIN3122
- » Hex Socket Adaptor 1/4" Hex - 1/4" 25mm

Item ID: **TTESK126**



**1/4", 3/8" & 1/2" SOCKET SET FOAM4X4 76 PIECES**

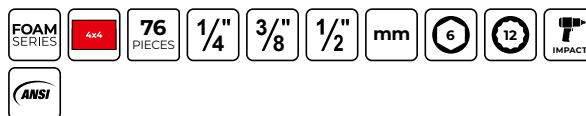

**CONTENTS**

- » 1/4" Socket 6 pt Metric
- » 4, 5, 5.5, 6, 7, 8, 9, 10, 11, 12, 13
- » 1/2" Socket 12 pt Metric
- » 10, 11, 12, 13, 14, 15, 16, 17, 18, 19, 22, 24
- » Reducing Adaptor 3/8"F - 1/4"M
- » Reducing Adaptor 1/2"F - 3/8"M
- » 1/2" Impact Socket ANSI Metric
- » 13, 15, 16, 17, 18, 19, 22, 24
- » 1/2" Universal Joint
- » 1/4" Universal Joint
- » 3/8" Universal Joint
- » 1/2" Extension Bar 255mm
- » 3/8" Socket 6 pt Metric
- » 8, 9, 10, 11, 12, 13, 14, 15, 16, 17, 18, 19, 22
- » 3/8" Wobble Extension Bar 75mm
- » 1/4" Deep Socket 6 pt Metric
- » 6, 7, 8, 10, 12, 13
- » 1/2" Ratchet FRP 45 Teeth
- » 1/2" Deep Impact Socket ANSI Metric
- » 13, 15, 16, 17, 18, 19, 22, 24
- » 1/2" Wobble Extension Bar 150mm
- » 3/8" Rotating Spinner Handle
- » 1/4" Extension Bar 150mm
- » 1/4" Extension Bar 305mm
- » Step Up Adaptor 3/8"F - 1/2"M
- » 3/8" Extension Bar 150mm
- » 1/4" Spinner Handle
- » T Bar Handle Grip
- » 1/4" Ratchet FRP 45 Teeth
- » 3/8" Ratchet FRP 45 Teeth

Item ID: **TTESK77**

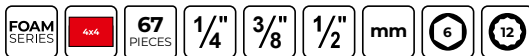

**NEW****1/4", 3/8" & 1/2" DRIVE METRIC SOCKET SET 67 PCS****CONTENTS**

- » 1/2" Breaker Bar 450 mm DIN3122
- » 1/2" Ratchet FRP 45 Teeth
- » 1/4" Ratchet FRP 45 Teeth
- » 3/8" Ratchet FRP 45 Teeth
- » 1/2" Wobble Extension Bar 150mm
- » 1/2" Extension Bar 255mm
- » 1/2" Universal Joint
- » 1/4" Universal Joint
- » 3/8" Universal Joint
- » Reducing Adaptor 1/2"F - 3/8"M
- » Reducing Adaptor 3/8"F - 1/4"M
- » 1/2" Socket 12 pt Metric
  - » 10, 11, 12, 13, 14, 15, 16, 17, 18, 19, 22, 24, 27, 30, 32
- » 1/4" Spinner Handle
- » 1/4" Extension Bar 50mm
- » 1/4" Extension Bar 100mm
- » 1/4" Extension Bar 305mm
- » 1/4" Socket 6 pt Metric
  - » 4, 5, 5.5, 6, 7, 8, 9, 10, 11, 12, 13
- » 1/4" Deep Socket 6 pt Metric
  - » 6, 7, 8, 9, 10, 11, 12, 13
- » 3/8" Wobble Extension Bar 75mm
- » 3/8" Extension Bar 150mm
- » Step Up Adaptor 3/8"F - 1/2"M
- » 3/8" Socket 6 pt Metric
  - » 8, 9, 10, 11, 12, 13, 14, 15, 16, 17, 18, 19, 22
- » 3/8" Rotating Spinner Handle
- » T Bar Handle Grip

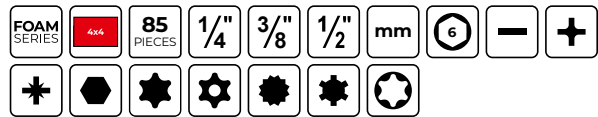
Item ID: **TTESK67****1/4", 3/8" & 1/2" SOCKET SET FOAM4X4 85 PIECES****CONTENTS**

- » 1/2" Long Ribe® Bit Socket
  - » 4, 5, 6, 8, 10, 11, 12, 13
- » 1/2" Long TX Bit Socket
  - » TX20, TX25, TX27, TX30, TX40, TX45, TX50, TX55, TX60
- » 1/4" TX Bit Socket
  - » 10, 15, 20, 25, 27, 30, 40
- » 1/4" PH Bit Socket
  - » PH0, PH1, PH2, PH3
- » 1/2" Long Hex Bit Socket Metric
  - » 5, 6, 7, 8, 10, 12
- » 3/8" Hex Bit Socket Metric
  - » 3, 4, 5, 5.5, 6, 7, 8, 10, 12
- » 3/8" TX Bit Socket
  - » TX10, TX15, TX20, TX25, TX27, TX30, TX40, TX45, TX50
- » 1/4" PZ Bit Socket
  - » PZ1, PZ2, PZ3
- » 1/4" TX-E Socket
  - » E4, E5, E6, E7, E8
- » 3/8" TPX Bit Socket
  - » TPX10, TPX15, TPX20, TPX25, TPX27, TPX30, TPX40, TPX45, TPX50
- » 3/8" TX-E Socket
  - » E10, E12, E14, E16, E18
- » 1/4" Flat Bit Socket
  - » 4, 5.5, 7
- » 1/2" Long XZN/Triple Square Bit Socket
  - » 5, 6, 8, 10, 12, 14, 16
- » 3/8" Extension Bar 75mm

Item ID: **TTESK85**



**1/2" IMPACT SOCKET SET ANSI FOAM2 21 PIECES**

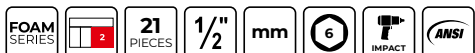

**CONTENTS**

- » Impact Step Up Adaptor 3/8"F (DIN) - 1/2"M (ANSI)
- » Impact Step Up Adaptor 1/2"F (DIN) - 3/4"M (ANSI)
- » 1/2" Impact Socket ANSI Metric
- » 13, 15, 16, 17, 18, 19, 22, 24
- » 1/2" Deep Impact Socket ANSI Metric
- » 13, 15, 16, 17, 18, 19, 22, 24
- » 1/2" Impact Universal Joint DIN (F) ANSI (M)
- » 1/2" Impact Extension Bar DIN (F) ANSI (M) 75mm
- » 1/2" Impact Extension Bar DIN (F) ANSI (M) 250mm

Item ID: **TED9121**



**1/2" DEEP IMPACT SOCKET SET AF DIN FOAM1 14 PIECES**

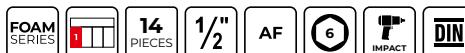

**CONTENTS**

- » 1/2" Deep Impact Socket DIN AF
- » 7/16, 1/2, 9/16, 5/8, 11/16, 3/4, 13/16, 7/8, 15/16, 1
- » Retaining Ring
- » 19 x 4, 24 x 4
- » Retaining Pin
- » 3 x 20, 3 x 25

Item ID: **TEA9214LAF**



**1/2" IMPACT SOCKET SET AF DIN FOAM1 16 PIECES**

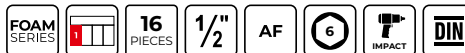

**CONTENTS**

- » 1/2" Impact Socket DIN AF
- » 3/8, 7/16, 1/2, 9/16, 5/8, 3/4, 13/16, 7/8, 1, 1-1/16, 1-1/8, 1-1/4
- » Retaining Ring
- » 19 x 4, 24 x 4
- » Retaining Pin
- » 3 x 20, 3 x 25

Item ID: **TEA9216AF**

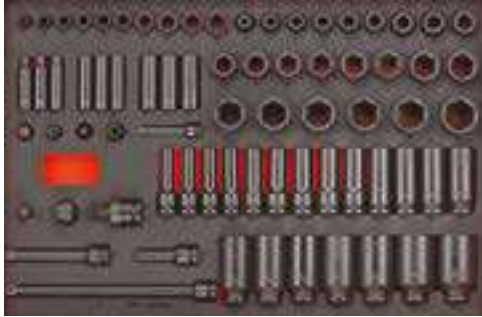
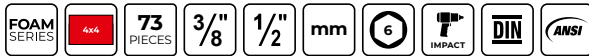

**3/8" & 1/2" IMPACT SOCKET SET FOAM4X4 73 PIECES****CONTENTS**

- » 1/2" Deep Impact Socket DIN Metric
  - » 10, 11, 12, 13, 14, 15, 16, 17, 18, 19, 21, 22, 24, 27, 28, 29, 30, 32, 35, 36
- » 1/2" Impact Socket DIN Metric
  - » 8, 10, 11, 12, 13, 14, 15, 16, 17, 18, 19, 20, 21, 22, 23, 24, 25, 26, 27, 28, 29, 30, 32
- » Impact Step Up Adaptor 3/8"F (DIN) - 1/2"M (ANSI)
- » Impact Step Up Adaptor 1/2"F (DIN) - 3/4"M (ANSI)
- » 3/8" Deep Impact Socket ANSI Metric
  - » 8, 10, 11, 12, 13, 14, 16, 17, 19
- » 1/2" Impact Extension Bar DIN 75mm
- » 1/2" Impact Extension Bar DIN 250mm
- » 1/2" Impact Extension Bar DIN 125mm
- » 3/8" Impact Socket ANSI Metric
  - » 8, 10, 11, 12, 13, 14, 15, 16, 17, 19
- » Retaining Ring
  - » 19 x 4, 24 x 4
- » Retaining Pin
  - » 3 x 20, 3 x 25
- » 1/2" Impact Coupler Adaptor 5/16" Hex
- » 3/8" Impact Coupler Adaptor 1/4" Hex
- » 1/2" Impact Universal Joint DIN
- » Impact Reducing Adaptor 1/2"F - 3/8"M DIN
- » Impact Reducing Adaptor 3/8"F - 1/4"M DIN

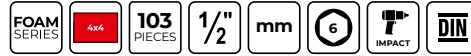
Item ID: **TTEISK73****NEW****1/2" SQUARE DRIVE IMPACT SOCKET SET 103 PIECES****CONTENTS**

- » 1/2" square drive impact socket set 103 pieces
  - » 1/2" Impact Extension Bar DIN 75 mm
  - » 1/2" Impact Extension Bar DIN 125 mm
  - » 1/2" Impact Extension Bar DIN 250 mm
  - » 1/2" Impact Universal Joint DIN
  - » Impact Reducing Adaptor 1/2"F - 3/8"M DIN
  - » Impact Step Up Adaptor 1/2"F - 3/4"M DIN
  - » 1/2" Impact Coupler Adaptor 5/16" Hex
  - » 1/2" Impact Socket DIN Metric
    - » 8, 10, 11, 12, 13, 14, 15, 16, 17, 18, 19, 21, 22, 24, 27, 28, 29, 30, 32
  - » 1/2" Deep Impact Socket DIN Metric
    - » 10, 11, 12, 13, 14, 15, 16, 17, 18, 19, 21, 22, 24, 27, 28, 29, 30, 32, 35, 36
  - » 1/4" PH G Impact Bits 30 mm PH2G x1
  - » 1/4" Hex Impact Bits 30mm
    - » 3, 4, 5, 6
  - » 1/4" Impact Driver
  - » 1/4" Magnetic Impact Bit Holder 60 mm
  - » 1/4" Impact Nut Setter
    - » 1/4, 7, 8, 10, 13
  - » Retaining Ring
    - » 19 x 4, 24 x 4
  - » Retaining Pin
    - » 3 x 20, 3 x 25
  - » 1/4" PH Impact Bits 30mm
    - » PH1, PH2, PH3
  - » 1/4" PZ Impact Bits 30mm
    - » PZ1, PZ2, PZ3
  - » 1/4" Quick Chuck Impact Bit Holder 60 mm
  - » 1/4" ROB Impact Bits 30mm
    - » 1, 2
  - » 1/4" TX Impact Bits 30mm
    - » TX10, TX15, TX20, TX25, TX27, TX30, TX40

Item ID: **TTEISK103**





**3/4" IMPACT SOCKET SET DIN FOAM4X4 33 PIECES**

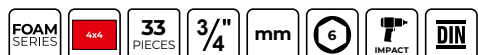

**CONTENTS**

- » 3/4" Deep Impact Socket DIN Metric  
19, 21, 22, 23, 24, 27, 30, 32, 33, 34, 36, 38, 41, 46
- » 3/4" Impact Socket DIN Metric  
19, 21, 22, 23, 24, 27, 28, 30, 32, 33, 34, 36, 38, 41, 46
- » Impact Step Up Adaptor 3/4"F - 1"M DIN
- » 3/4" Impact Universal Joint DIN
- » Retaining Ring 36 x 5.0mm
- » Retaining Pin 4 x 35mm
- » Impact Reducing Adaptor 3/4"F - 1/2"M DIN

Item ID: **TTEISK33**



**TORQUE SCREWDRIVER SET FOAM2 95 PIECES**

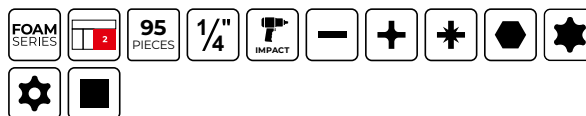

**CONTENTS**

- » 1/4" TX Bits 25mm  
TX6, TX7, TX8, TX9, TX10, TX15, TX20, TX25, TX27, TX30, TX40
- » 1/4" PH Bits 25mm  
PH1, PH2, PH3
- » 5/16" Flat Impact Driver Bits  
6, 8, 10, 12
- » 5/16" PH Impact Driver Bits  
PH1, PH2, PH3, PH4
- » 5/16" Hex Impact Driver Bits  
4, 5, 6, 8
- » 1/4" TPX Bits 25mm  
TPX10, TPX15, TPX20, TPX25, TPX27, TPX30, TPX40
- » 1/4" Hex Bits 25mm  
2, 3, 4, 5, 6, 8
- » 5/16" TX Impact Driver Bits  
TX30, TX40, TX45, TX50, TX55
- » 1/4" PH G Bits 25mm PH2G 10 pcs
- » 1/4" Torque Screwdriver 1-5Nm
- » 1/4" ROB Bits 25mm  
1, 2, 3
- » 1/4" Flat Bits 25mm  
0.6 x 3.5, 0.6 x 4.5, 0.8 x 4.0, 0.8 x 5.5, 1.0 x 5.5, 1.2 x 6.5, 1.6 x 8.0
- » 1/4" PZ Bits 25mm  
PZ1, PZ2, PZ3
- » 1/2" Impact Coupler Adaptor 5/16" Hex
- » 1/4" Ratcheting Bits Driver Set
- » 1/4" Bits Driver Extension 150mm Flexible
- » 1/4" Quick Chuck Bit Holder 35mm
- » 1/4" Sliding T Bar
- » Hex Socket Adaptor 5/16" Hex - 3/8"

Item ID: **TEDSD14**

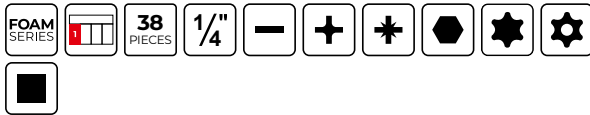

**TORQUE SCREWDRIVER SET FOAM1 38 PIECES****CONTENTS**

- » Hex Socket Adaptor 1/4" Hex - 1/4" 30mm
- » 1/4" TX Bits 25mm
  - » TX8, TX9, TX10, TX15, TX20, TX25, TX27, TX30, TX40
- » 1/4" PH Bits 25mm
  - » PH0, PH1, PH2, PH3
- » 1/4" TPX Bits 25mm
  - » TPX10, TPX15, TPX20, TPX30, TPX40
- » 1/4" Hex Bits 25mm
  - » 2, 3, 4, 5, 6
- » 1/4" PH G Bits 25mm PH2G 10 pcs
- » 1/4" Torque Screwdriver 1-5Nm
- » 1/4" ROB Bits 25mm
  - » 1, 2, 3
- » 1/4" Flat Bits 25mm
  - » 0.6 x 4.5, 0.8 x 5.5, 1.2 x 6.5, 3
- » 1/4" PZ Bits 25mm
  - » PZ0, PZ1, PZ2, PZ3

Item ID: **TEASD38****INSULATED TORQUE SCREWDRIVER SET FOAM1 9 PIECES****CONTENTS**

- » Interchangeable Blade Insulated Screwdriver
  - » 3, 4, 5.5, 6.5, PH1, PH2, PZ1, PZ2
- » Insulated Torque Screwdriver 1-5Nm

Item ID: **TEAVSD09****1/4" TORQUE SET FOAMX2 2 PIECES****CONTENTS**

- » 1/4" Torque Screwdriver 1-5Nm
- » 1/4" Torque Wrench 5 - 25Nm

Item ID: **TEZSD02**



**3/8" & 1/2" TORQUE WRENCH SET FOAMX4 2 PIECES**



**CONTENTS**

- » 3/8" Torque Wrench 20 - 110Nm
- » 1/2" Torque Wrench 40 - 210Nm

Item ID: **TEX1238**



**1/2" TORQUE MULTIPLIER SET FOAMX4 2 PIECES**



**CONTENTS**

- » Torque Multiplier 1:3 1/2"F - 3/4"M
- » 1/2" Torque Wrench 40 - 210Nm

Item ID: **TEXMP12**



**COMBINATION SPANNER SET ANTI SLIP FOAM2 12 PIECES**



**CONTENTS**

- » Combination Spanner Anti Slip Metric
- » 8, 9, 10, 11, 12, 13, 14, 15, 16, 17, 18, 19

Item ID: **TED8012**



**COMBINATION SPANNER SET FOAM2 15 PIECES**



**CONTENTS**

- » Combination Spanner Metric
- » 5.5, 6, 7, 8, 9, 10, 11, 12, 13, 14, 15, 16, 17, 18, 19

Item ID: **TED6515**



**COMBINATION SPANNER SET FOAMX4 7 PIECES****CONTENTS**

- » Combination Spanner Metric
- » 20, 21, 22, 24, 27, 30, 32

Item ID: **TEX2032****RATCHETING COMBINATION SPANNER SET RS FOAM2 12 PIECES****CONTENTS**

- » Ratcheting Combination Spanner Metric RS
- » 8, 9, 10, 11, 12, 13, 14, 15, 16, 17, 18, 19

Item ID: **TED6512RS****RATCHETING COMBINATION SPANNER SET R FOAM2 12 PIECES****CONTENTS**

- » Ratcheting Combination Spanner Metric R
- » 8, 9, 10, 11, 12, 13, 14, 15, 16, 17, 18, 19

Item ID: **TED6512R****DOUBLE RING SPANNER SET FOAMX4 8 PIECES****CONTENTS**

- » Double Ring Spanner Metric
- » 6 x 7, 8 x 9, 10 x 11, 12 x 13, 14 x 15, 16 x 17, 18 x 19, 20 x 22

Item ID: **TEX6308**



**LONG DOUBLE RING SPANNER SET FOAMX4 6 PIECES**

FOAM SERIES **6** PIECES

**CONTENTS**

- » Long Double Ring Spanner Metric
- » 8 x 10, 11 x 13, 12 x 14, 16 x 18, 17 x 19, 22 x 24

Item ID: **TEXFLS06**



**SPANNER & FILE SET FOAM4X4 32 PIECES**

FOAM SERIES **32** PIECES **mm** **CrV** STEEL

**CONTENTS**

- » Combination Spanner Metric
- » 8, 9, 10, 11, 12, 13, 14, 15, 16, 17, 18, 19, 20, 21, 22, 24, 27, 30, 32
- » Ratcheting Combination Spanner Metric RS
- » 8, 10, 11, 12, 13, 14, 17, 19
- » Hand File 250mm Half round
- » Hand File 250mm Round
- » Hand File 250mm Triangular
- » Hand File 250mm Flat Tapered
- » Hand File 250mm Flat

Item ID: **TTEX32**



**SPANNER SET FOAM4X4 37 PIECES**

FOAM SERIES **37** PIECES **mm** **CrV** STEEL

**CONTENTS**

- » Double Open Ended Spanner Metric
- » 6 x 7, 8 x 9, 10 x 11, 12 x 13, 14 x 15, 16 x 17, 18 x 19, 20 x 22, 21 x 23, 24 x 27, 30 x 32
- » Ratcheting Combination Spanner Metric R
- » 8, 9, 10, 11, 12, 13, 14, 15, 16, 17, 18, 19, 22, 24, 27
- » Double Ring Spanner Metric
- » 6 x 7, 8 x 9, 10 x 11, 12 x 13, 14 x 15, 16 x 17, 18 x 19, 20 x 22, 21 x 23, 24 x 27, 30 x 32

Item ID: **TTESP37**



**COMBINATION SPANNER SET FOAM4X4 31 PIECES**

FOAM SERIES **31** PIECES **mm** **CrV** STEEL

**CONTENTS**

- » Combination Spanner Metric
- » 5.5, 6, 7, 8, 9, 10, 11, 12, 13, 14, 15, 16, 17, 18, 19, 20, 21, 22, 23, 24, 25, 26, 27, 28, 29, 30, 32, 33, 34, 36, 38

Item ID: **TTESP31**



**NEW****METRIC COMBINATION & RATCHETING SPANNER SET****CONTENTS**

- » Combination Spanner Metric
  - » 8, 9, 10, 11, 12, 13, 14, 15, 16, 17, 18, 19, 20, 21, 22, 24, 27, 30, 32
- » Ratcheting Combination Spanner Metric R
  - » 8, 9, 10, 11, 12, 13, 14, 15, 16, 17, 18, 19

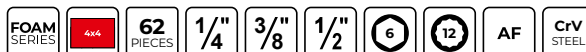
Item ID: **TTESP31A****SOCKET & COMBINATION SPANNER SET AF FOAM4X4 62 PIECES****CONTENTS**

- » 3/8" Deep Socket 6 pt AF
  - » 3/8, 7/16, 1/2, 9/16, 5/8, 11/16, 3/4
- » Combination Spanner AF
  - » 5/16, 3/8, 7/16, 1/2, 9/16, 5/8, 11/16, 3/4, 13/16, 7/8, 15/16, 1, 1-1/16, 1-1/8, 1-1/4
- » 1/4" Socket 6 pt AF
  - » 3/16, 7/32, 9/32, 5/16, 11/32, 3/8, 7/16, 1/2
- » 3/8" Socket 6 pt AF
  - » 3/8, 7/16, 1/2, 9/16, 5/8, 11/16, 3/4
- » 1/2" Socket 12 pt AF
  - » 3/8, 7/16, 1/2, 9/16, 5/8, 11/16, 3/4, 13/16, 7/8, 15/16, 1, 1-1/16, 1-1/8, 1-3/16, 1-1/4
- » 1/4" Deep Socket 6 pt AF
  - » 3/16, 7/32, 9/32, 5/16, 11/32, 3/8, 7/16, 1/2

Item ID: **TTEAF62**





**ADJUSTABLE WRENCH SET FOAM2 4 PIECES**



**CONTENTS**

- » Adjustable Wrench Wide Jaw 200mm
- » Adjustable Wrench TPR Grip 200mm
- » Adjustable Wrench TPR Grip 150mm
- » Adjustable Wrench TPR Grip 250mm

Item ID: **TEDADJ4**



**DOUBLE FLEX WRENCH SET FOAM2 7 PIECES**



**CONTENTS**

- » Double Flex Wrench Metric
- » 8 x 9, 10 x 11, 12 x 13, 14 x 15, 16 x 17, 18 x 19
- » Bi-flex Wrench 1/4" Hex x 1/4"

Item ID: **TEDDF7**



**SCREWDRIVER SET FLAT FOAM1 4 PIECES****CONTENTS**

- » Flat Screwdriver
- » 0.5 x 3.0, 0.8 x 4.0, 1.0 x 5.5, 1.2 x 6.5

Item ID: **TEAMD04N****SCREWDRIVER SET TX FOAM1 4 PIECES****CONTENTS**

- » TX Screwdriver
- » TX10, TX15, TX20, TX25

Item ID: **TEAMD04TXN****SCREWDRIVER SET PH/PZ FOAM1 4 PIECES****CONTENTS**

- » PH Screwdriver
- » PH0, PH1, PH2
- » PZ Screwdriver PZ1 x 75mm M

Item ID: **TEAMD04NI****SCREWDRIVER SET MIXED FOAM2 11 PIECES****CONTENTS**

- » PH Screwdriver
- » PH0, PH1, PH2 (x2)
- » Flat Screwdriver
- » 0.6 x 3.5, 1.0 x 5.5 (x2), 1.2 x 6.5 (x2)
- » PZ Screwdriver
- » PZ1, PZ2

Item ID: **TED911N**



**SCREWDRIVER SET FLAT & PH FOAMX4 5 PIECES**



**CONTENTS**

- » Flat Screwdriver
- » 1.0 x 5.5, 1.2 x 6.5, 1.2 x 8.0, 1.6 x 10.0
- » PH Screwdriver PH3 x 150mm XL Hex Shaft

Item ID: **TEX915N**



**SCREWDRIVER SET TX FOAM2 9 PIECES**



**CONTENTS**

- » TX Screwdriver
- » TX6, TX8, TX9, TX10, TX15, TX20, TX25, TX27, TX30

Item ID: **TED909TXN**



**STUBBY SCREWDRIVER SET FOAMX2 6 PIECES**



**CONTENTS**

- » PZ Screwdriver
- » PZ1, PZ2
- » PH Screwdriver
- » PH1, PH2
- » Flat Screwdriver 1.2 x 6.5 x 38mm XS
- » 1/4" Stubby Bits Driver

Item ID: **TEZMD06**





### SCREWDRIVER SET MIXED FOAM4X4 122 PIECES



#### CONTENTS

- » 1/4" TX Bits 25mm
  - » TX6, TX7, TX8, TX9, TX10, TX15, TX20, TX25, TX27, TX30, TX40
- » 1/4" PH Bits 25mm
  - » PH1, PH2, PH3
- » 1/4" Flat Bits 50mm
  - » 0.6 x 3.5, 0.8 x 4.0, 0.8 x 5.5, 1.0 x 5.5, 1.2 x 6.5
- » PH Screwdriver
  - » PH0, PH1 (x2), PH2 (x2), PH3, PH4
- » 1/4" TX Bits 50mm
  - » TX8, TX10, TX15, TX20, TX25, TX27, TX30
- » Flat Screwdriver
  - » 0.5 x 2.5, 0.5 x 3.0, 0.6 x 3.5, 0.8 x 4.0, 1.0 x 5.5 (x2), 1.2 x 6.5 (x3), 1.2 x 8.0, 1.6 x 10.0
- » PZ Screwdriver
  - » PZ0, PZ1 (x2), PZ2 (x3), PZ3
- » 1/4" TPX Bits 25mm
  - » TPX10, TPX15, TPX20, TPX25, TPX27, TPX30, TPX40
- » 1/4" PZ Bits 50mm
  - » PZ1, PZ2, PZ3
- » 1/4" Hex Bits 25mm
  - » 2, 3, 4, 5, 6, 8
- » 1/4" PH Bits 50mm
  - » PH1, PH2, PH3
- » 1/4" PH G Bits 25mm PH2G 10 pcs
- » 1/4" ROB Bits 25mm
  - » 1, 2, 3
- » 1/4" Hex Bits 50mm
  - » 4, 5, 6, 8
- » 1/4" Flat Bits 25mm
  - » 0.6 x 3.5, 0.6 x 4.5, 0.8 x 4.0, 0.8 x 5.5, 1.0 x 5.5, 1.2 x 6.5, 1.6 x 8.0
- » 1/4" PZ Bits 25mm
  - » PZ1, PZ2, PZ3
- » 1/4" Ratcheting Bits Driver Set

Item ID: **TTEMD122N**



### SCREWDRIVER SET MIXED FOAM4X4 98 PIECES

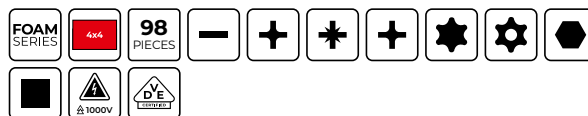

#### CONTENTS

- » 1/4" TX Bits 25mm
  - » TX6, TX7, TX8, TX9, TX10, TX15, TX20, TX25, TX27, TX30, TX40
- » 1/4" PH Bits 25mm
  - » PH1, PH2, PH3
- » PH Power Thru Screwdriver
  - » PH2, PH3
- » 1/4" TPX Bits 25mm
  - » TPX10, TPX15, TPX20, TPX25, TPX27, TPX30, TPX40
- » 1/4" Hex Bits 25mm
  - » 2, 3, 4, 5, 6, 8
- » Flat Insulated Screwdriver
  - » 0.4 x 2.5, 0.8 x 4.0, 1.0 x 5.5
- » TPX Screwdriver
  - » TPX10, TPX15, TPX20, TPX25, TPX30
- » 1/4" Bits Driver Extension 100mm
- » 1/4" Bits Driver Extension 150mm Flexible
- » 1/4" PH G Bits 25mm PH2G 10 pcs
- » Mini Screwdriver Set Flat & PH 6 Pieces
- » 1/4" ROB Bits 25mm
  - » 1, 2, 3
- » 1/4" Flat Bits 25mm
  - » 0.6 x 3.5, 0.6 x 4.5, 0.8 x 4.0, 0.8 x 5.5, 1.0 x 5.5, 1.2 x 6.5, 1.6 x 8.0
- » Flat Power Thru Screwdriver
  - » 1.2 x 6.5, 1.2 x 8, 1.6 x 10
- » Mini Screwdriver Set TX 6 Pieces
- » 1/4" PZ Bits 25mm
  - » PZ1, PZ2, PZ3
- » PZ Insulated Screwdriver PZ2
- » Magnetic Screwdriver Charger
- » PH Insulated Screwdriver
  - » PH0, PH1, PH2
- » TX Screwdriver
  - » TX8, TX9
- » 1/4" Ratcheting Bits Driver Set
- » 1/4" Bit Adaptor Hex Bit Coupler
- » Hex Socket Adaptor 1/4" Hex - 1/4" 25mm

Item ID: **TTEMD98N**





**SCREWDRIVER & SPANNER SET FOAM4X4 33 PIECES**



**CONTENTS**

- » Combination Spanner Metric  
8, 10, 11, 12, 13, 14, 15, 16, 17, 18, 19
- » PH Screwdriver  
PH1, PH2
- » TPX Screwdriver  
TPX10, TPX15, TPX20, TPX25, TPX30
- » Flat Screwdriver  
0.5 x 2.5, 0.6 x 3.5, 0.8 x 4.0, 1.0 x 5.5
- » Ball Point Hex Key Set 9 Pieces
- » TX Screwdriver  
TX8, TX9

Item ID: **TTEMD33**



**SCREWDRIVER & HEX/TX KEY SET 1 FOAM3 54 PIECES**

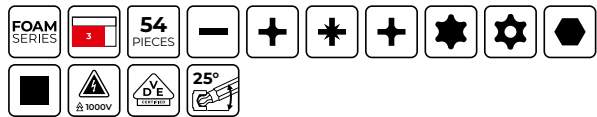

**CONTENTS**

- » 1/4" PH Bits 25mm  
PH1, PH2, PH3
- » 1/4" TPX Bits 25mm  
TPX20, TPX25, TPX30
- » PZ Screwdriver PZ2 x 100mm L
- » 1/4" Hex Bits 25mm  
2, 3, 4, 5, 6, 8
- » Flat Slim Insulated Screwdriver 0.8 x 4.0mm
- » Flat Screwdriver 1.2 x 6.5 x 100mm L Hex Shaft
- » 1/4" TX Bits 25mm  
TX10, TX15, TX20, TX25, TX30, TX40
- » Measuring Tape Metric 5m
- » PH Slim Insulated Screwdriver PH1
- » 1/4" ROB Bits 25mm  
1, 2, 3
- » PH Screwdriver PH2 x 100mm L
- » 1/4" PZ Bits 25mm  
PZ1, PZ2, PZ3
- » 1/4" Flat Bits 25mm  
0.6 x 3.5, 1.0 x 5.5, 1.6 x 8.0
- » Hose Clip Driver 7mm
- » Ball Point Hex Key Set A 9 Pieces
- » 1/4" Quick Chuck Bits Driver 217mm
- » TX Key Set 9 Pieces
- » PZ Slim Insulated Screwdriver PZ1

Item ID: **TEFMD54**







### SCREWDRIVER & HEX/TX KEY SET 2 FOAM3 54 PIECES

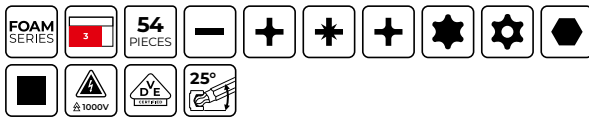

#### CONTENTS

- » 1/4" PH Bits 25mm
  - » PH1, PH2, PH3
- » 1/4" TPX Bits 25mm
  - » TPX20, TPX25, TPX30
- » PZ Screwdriver PZ2 x 100mm L
- » 1/4" Hex Bits 25mm
  - » 2, 3, 4, 5, 6, 8
- » Flat Slim Insulated Screwdriver 0.8 x 4.0mm
- » Flat Screwdriver 1.2 x 6.5 x 100mm L Hex Shaft
- » 1/4" TX Bits 25mm
  - » TX10, TX15, TX20, TX25, TX30, TX40
- » PH Slim Insulated Screwdriver PH1
- » 1/4" ROB Bits 25mm
  - » 1, 2, 3
- » PH Screwdriver PH2 x 100mm L
- » 1/4" PZ Bits 25mm
  - » PZ1, PZ2, PZ3
- » Measuring Tape Metric/Inch 5m
- » 1/4" Flat Bits 25mm
  - » 0.6 x 3.5, 1.0 x 5.5, 1.6 x 8.0
- » Hose Clip Driver 7mm
- » Ball Point Hex Key Set A 9 Pieces
- » 1/4" Quick Chuck Bits Driver 217mm
- » TX Key Set 9 Pieces
- » PZ Slim Insulated Screwdriver PZ1

Item ID: **TEFMDI54**



### POWER THRU SCREWDRIVER SET FOAMX4 5 PIECES



#### CONTENTS

- » PH Power Thru Screwdriver
  - » PH2, PH3
- » Flat Power Thru Screwdriver
  - » 1.2 x 6.5, 1.2 x 8, 1.6 x 10

Item ID: **TEXMDTN**







**BITS DRIVER SET FOAM1 78 PIECES**

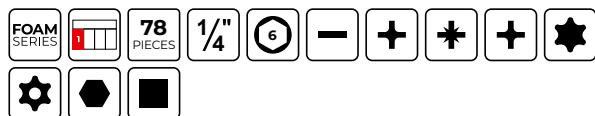

**CONTENTS**

- » Hex Socket Adaptor 1/4" Hex - 1/4" 30mm
- » 1/4" TX Bits 25mm
  - » TX6, TX7, TX8, TX9, TX10, TX15, TX20, TX25, TX27, TX30, TX40
- » 1/4" PH Bits 25mm
  - » PH1, PH2, PH3
- » 1/4" Socket 6 pt Metric
  - » 4, 5, 5.5, 6, 7, 8, 9, 10, 11, 12, 13
- » 1/4" TPX Bits 25mm
  - » TPX10, TPX15, TPX20, TPX25, TPX27, TPX30, TPX40
- » 1/4" Hex Bits 25mm
  - » 2, 3, 4, 5, 6, 8
- » 1/4" PH G Bits 25mm PH2G 10 pcs
- » 1/4" Magnetic Bit Holder 50mm
- » 1/4" ROB Bits 25mm
  - » 1, 2, 3
- » 1/4" Flat Bits 25mm
  - » 0.6 x 3.5, 0.6 x 4.5, 0.8 x 4.0, 0.8 x 5.5, 1.0 x 5.5, 1.2 x 6.5, 1.6 x 8.0
- » 1/4" PZ Bits 25mm
  - » PZ1, PZ2, PZ3
- » 1/4" Ratchet Head Hex/Square Drive
- » 1/4" Quick Chuck Bits Driver 147mm

Item ID: **TEAMDQ78**



**IMPACT BIT SET FOAM1 50 PIECES**



**CONTENTS**

- » 1/4" PZ Impact Bits 30mm
  - » PZ1, PZ2, PZ3
- » 1/4" TX Impact Bits 30mm
  - » TX10, TX15, TX20, TX25, TX27, TX30, TX40
- » 1/4" ROB Impact Bits 50mm
  - » 1, 2, 3
- » 1/4" PZ Impact Bits 50mm
  - » PZ1, PZ2, PZ3
- » 1/4" PH Impact Bits 50mm
  - » PH1, PH2, PH3
- » 1/4" PH G Impact Bits 30mm PH2G 1 pc
- » 1/4" Hex Impact Bits 30mm
  - » 3, 4, 5, 6
- » 1/4" PH Impact Bits 30mm
  - » PH1, PH2, PH3
- » 1/4" Hex Impact Bits 50mm
  - » 3, 4, 5, 6
- » 1/4" Magnetic Impact Bit Holder 60mm
- » 1/4" ROB Impact Bits 30mm
  - » 1, 2
- » 1/4" TX Impact Bits 50mm
  - » TX10, TX15, TX20, TX25, TX27, TX30, TX40
- » 1/4" Quick Chuck Impact Bit Holder 60mm
- » 1/4" PH G Impact Bits 50mm PH2G 1 pc

Item ID: **TEABS50**



**T-HANDLE BALL POINT HEX KEY SET FOAM2 7 PIECES****CONTENTS**

- » T Handle Ball Point Hex Key Metric
- » 2.5, 3, 4, 5, 6, 7, 8

Item ID: **TEDHEX7****BALL POINT HEX & TX KEY SET FOAM2 42 PIECES****CONTENTS**

- » Mini TX Key
- » TX6, TX7, TX8, TX9, TX10, TX15
- » Ball Point Hex Key Metric 7mm
- » Ball Point Hex Key Set 9 Pieces
- » Folding Key Set Mixed 8 Pieces
- » Ball Point Hex Key Set AF 9 Pieces
- » TX Key Set 9 Pieces

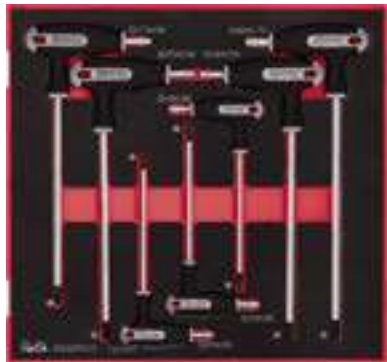
Item ID: **TEDHT42****T-HANDLE BALL POINT TX KEY SET FOAM2 7 PIECES****CONTENTS**

- » T Handle Ball Point TX Key
- » TX10, TX15, TX20, TX25, TX27, TX30, TX40

Item ID: **TEDTX7****NEW****PLIER SET VINYL GRIP Q FOAM2 5 PIECES****CONTENTS**

- » Quick Set Water Pump Plier HRC60 250mm
- » Heavy Duty Combination Plier 200mm
- » Long Nose Plier 200mm
- » Side Cutting Plier 135mm
- » Heavy Duty Side Cutting Plier 200mm

Item ID: **TED441Q**

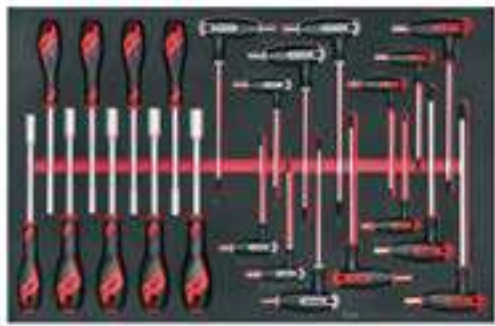

**NUT DRIVER & HEX/TX T-HANDLE SET FOAM4X4 23 PIECES**



**CONTENTS**

- » T Handle Ball Point Hex Key Metric
- » 2.5, 3, 4, 5, 6, 7, 8
- » T Handle Ball Point TX Key
- » TX10, TX15, TX20, TX25, TX27, TX30, TX40
- » Nut Driver
- » 5, 5.5, 6, 7, 8, 10, 11, 12, 13

Item ID: **TTEX23N**



**PLIER SET TPR GRIP FOAM2 5 PIECES**



**CONTENTS**

- » Side Cutting Plier TPR Grip 140mm
- » Heavy Duty Combination Plier TPR Grip 200mm
- » Water Pump Plier TPR Grip 250mm
- » Heavy Duty Side Cutting Plier TPR Grip 200mm
- » Long Nose Plier TPR Grip 205mm

Item ID: **TED441-T**



**NEW**

**PLIER SET TPR GRIP Q FOAM2 5 PIECES**



**CONTENTS**

- » Side Cutting Plier TPR Grip 140mm
- » Quick Set Water Pump Plier TPR Grip HRC60 250mm
- » Heavy Duty Combination Plier TPR Grip 200mm
- » Heavy Duty Side Cutting Plier TPR Grip 200mm
- » Long Nose Plier TPR Grip 205mm

Item ID: **TED441-TQ**



**POWER GRIP PLIER SET FOAMX2 3 PIECES**



**CONTENTS**

- » Long Nose Power Grip Plier 125mm
- » Long Nose Power Grip Plier 170mm
- » Curved Jaw Power Grip Plier 105mm

Item ID: **TEZVG03**



**PLIER SET FOAM4X4 11 PIECES****CONTENTS**

- » Circlip Plier Inner Straight 185mm
- » Curved Jaw Power Grip Plier 235mm
- » Curved Jaw Power Grip Plier 105mm
- » Circlip Plier Outer Straight 180mm
- » Water Pump Plier TPR Grip 250mm
- » Heavy Duty Side Cutting Plier TPR Grip 200mm
- » Long Nose Power Grip Plier 170mm
- » Heavy Duty Combination Plier TPR Grip 190mm
- » Circlip Plier Outer Bent 165mm
- » Long Nose Plier TPR Grip 205mm
- » Circlip Plier Inner Bent 170mm

Item ID: **TTEMB11****PLIER SET FOAM4X4 17 PIECES****CONTENTS**

- » Side Cutting Plier TPR Grip 140mm
- » Side Cutting Plier TPR Grip 160mm
- » Water Pump Plier TPR Grip 185mm
- » Water Pump Plier TPR Grip 250mm
- » Heavy Duty Combination Plier TPR Grip 200mm
- » Heavy Duty Combination Plier TPR Grip 190mm
- » Heavy Duty Side Cutting Plier TPR Grip 165mm
- » Heavy Duty Side Cutting Plier TPR Grip 200mm
- » Heavy Duty Side Cutting Plier Offset TPR Grip 200mm
- » Cable Cutter TPR Grip 208mm
- » Circlip Plier Inner Straight 185mm
- » Flat Nose Plier TPR Grip 170mm
- » Circlip Plier Outer Straight 180mm
- » Circlip Plier Outer Bent 165mm
- » Wire Stripping Plier TPR Grip
- » Long Nose Plier TPR Grip 205mm
- » Circlip Plier Inner Bent 170mm

Item ID: **TTEMB17**

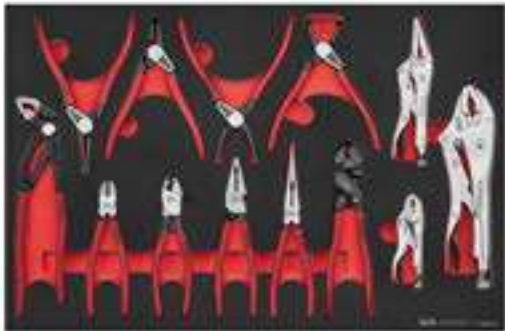

**PLIER SET Q FOAM4X4 13 PIECES**



**CONTENTS**

- » Mini Bolt Cutter 200mm
- » Cable Cutter 160mm
- » Curved Jaw Power Grip Plier 235mm
- » Curved Jaw Power Grip Plier 105mm
- » Quick Set Water Pump Plier HRC60 250mm
- » Long Nose Power Grip Plier 170mm
- » Circlip Plier Inner Straight PRO 175mm
- » Circlip Plier Outer Bent PRO 165mm
- » Circlip Plier Outer Straight PRO 175mm
- » Circlip Plier Inner Bent PRO 175mm
- » Heavy Duty Combination Plier 185mm
- » Long Nose Plier 200mm
- » Side Cutting Plier 160mm

Item ID: **TTEMB13Q**

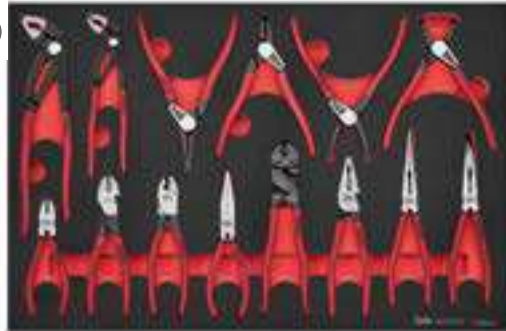

**PLIER SET VINYL GRIP Q FOAM4X4 14 PIECES**



**CONTENTS**

- » Quick Set Water Pump Plier HRC60 185mm
- » Quick Set Water Pump Plier HRC60 250mm
- » Mini Bolt Cutter 200mm
- » Cable Cutter 160mm
- » Bent Long Nose Plier 200mm
- » Flat Nose Plier 165mm
- » Circlip Plier Inner Straight PRO 175mm
- » Circlip Plier Outer Bent PRO 165mm
- » Circlip Plier Outer Straight PRO 175mm
- » Circlip Plier Inner Bent PRO 175mm
- » Heavy Duty Combination Plier 185mm
- » Long Nose Plier 200mm
- » Heavy Duty Side Cutting Plier 160mm
- » Side Cutting Plier 135mm

Item ID: **TTEMB14Q**





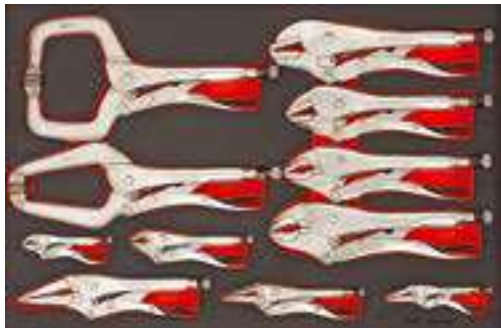

**POWER GRIP PLIER SET FOAM4X4 11 PIECES**



**CONTENTS**

- » Flat Jaw Power Grip Plier 300mm
- » Flat Jaw Power Grip Plier 250mm
- » Long Nose Power Grip Plier 125mm
- » Long Nose Power Grip Plier 170mm
- » Long Nose Power Grip Plier 230mm
- » Curved Jaw Power Grip Plier 235mm
- » Curved Jaw Power Grip Plier 125mm
- » Curved Jaw Power Grip Plier 105mm
- » Curved Jaw Power Grip Plier 300mm
- » Swivel C Clamp Power Grip Plier 280mm
- » Swivel Clamping Power Grip Plier 300mm

Item ID: **TTEVG11**



**INSULATED INTERCHANGEABLE BLADE SET FOAM1 10 PIECES**



**CONTENTS**

- » Interchangeable Blade Insulated Screwdriver
- » 3, 4, 5.5, 6.5, PH1, PH2, PZ1, PZ2
- » Insulated Handle for Interchangeable Blades S
- » Insulated Handle for Interchangeable Blades L

Item ID: **TEAMDV10**



**INSULATED SCREWDRIVER SET FLAT FOAM1 4 PIECES**



**CONTENTS**

- » Flat Slim Insulated Screwdriver
- » 0.8 x 4.0, 1.0 x 5.5
- » Flat Insulated Screwdriver
- » 0.4 x 2.5, 0.5 x 3.0

Item ID: **TEAMDV04N**







**INSULATED SCREWDRIVER SET PH/PZ FOAM1 4 PIECES**



**CONTENTS**

- » PH Slim Insulated Screwdriver  
PH1, PH2
- » PZ Slim Insulated Screwdriver  
PZ1, PZ2

Item ID: **TEAMDV04N1**



**INSULATED SCREWDRIVER SET FOAM3 12 PIECES**



**CONTENTS**

- » PH Insulated Screwdriver  
PH0, PH3
- » Flat Slim Insulated Screwdriver  
0.8 x 4.0, 1.0 x 5.5
- » PH Slim Insulated Screwdriver  
PH1, PH2
- » PZ Slim Insulated Screwdriver  
PZ1, PZ2
- » Flat Insulated Screwdriver  
0.4 x 2.5, 0.5 x 3.0
- » PZ Insulated Screwdriver  
PZ0, PZ3

Item ID: **TEFMDV12**



**INSULATED SCREWDRIVER SET MIXED FOAM2 9 PIECES**



**CONTENTS**

- » Flat Insulated Screwdriver  
0.4 x 2.5, 0.6 x 3.5, 0.8 x 4.0, 1.0 x 5.5
- » Voltage Tester
- » PZ Insulated Screwdriver PZ2
- » PH Insulated Screwdriver  
PH0, PH1, PH2

Item ID: **TEDV909N**





**NEW**

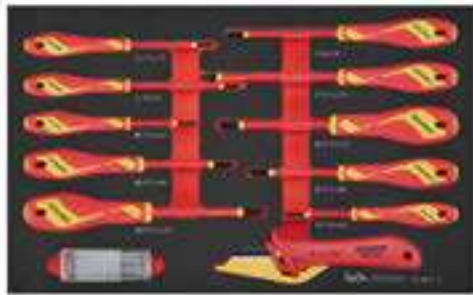

**INSULATED SCREWDRIVER & KNIFE SET FOAM3 15 PIECES**



**CONTENTS**

- » Flat Insulated Screwdriver  
0.4 x 2.5, 0.5 x 3.0, 0.8 x 4.0, 1.0 x 5.5
- » Replacement Blades For Insulated Knife
- » PZ Insulated Screwdriver  
PZ0, PZ1, PZ2
- » PH Insulated Screwdriver  
PH0, PH1, PH2
- » Insulated Knife

Item ID: **TEFMDV15**

**INSULATED PLIER & SCREWDRIVER SET FOAM3 11 PIECES**



**CONTENTS**

- » Insulated Long Nose Plier 215mm
- » Flat Slim Insulated Screwdriver 0.8 x 4.0mm
- » PH Slim Insulated Screwdriver  
PH1, PH2
- » Insulated Wire Stripping Plier
- » Voltage Tester
- » PZ Slim Insulated Screwdriver  
PZ1, PZ2
- » Insulated Combination Plier 185mm
- » Flat Insulated Screwdriver 0.4 x 2.5mm
- » Insulated Side Cutting Plier 160mm

Item ID: **TEFXV11**





**NEW**



**INSULATED SPANNER & SCREWDRIVER SET FOAM3 17 PIECES**



**CONTENTS**

- » Flat Insulated Screwdriver
- » 0.8 x 4.0, 1.0 x 5.5
- » Replacement Blades For Insulated Knife
- » PZ Insulated Screwdriver PZ2
- » Insulated Spanner
- » 8, 10, 12, 13, 14, 17, 19
- » PH Insulated Screwdriver
- » PH1, PH2
- » Insulated Knife

Item ID: **TEFXV17**



**INSULATED PLIER SET FOAM2 4 PIECES**



**CONTENTS**

- » Insulated Long Nose Plier 215mm
- » Insulated Wire Stripping Plier
- » Insulated Combination Plier 185mm
- » Insulated Side Cutting Plier 160mm

Item ID: **TEDV440**



**NEW**



**INSULATED PLIER & KNIFE SET FOAM2 8 PIECES**



**CONTENTS**

- » Insulated Long Nose Plier Bent 210mm
- » Replacement Blades For Insulated Knife
- » Insulated Water Pump Plier 260mm
- » Insulated Cable Cutter 210mm
- » Insulated Knife

Item ID: **TEDVMB08**





**NEW**



**INSULATED PLIER SET FOAM3 7 PIECES**



**CONTENTS**

- » Insulated Long Nose Plier 215mm
- » Insulated Long Nose Plier Bent 210mm
- » Insulated Wire Stripping Plier
- » Insulated Water Pump Plier 260mm
- » Insulated Cable Cutter 210mm
- » Insulated Combination Plier 185mm
- » Insulated Side Cutting Plier 160mm

Item ID: **TEFMBV07**



**3/8" INSULATED SOCKET SET FOAM2 18 PIECES**



**CONTENTS**

- » 3/8" Insulated Socket  
6, 7, 8, 9, 10, 11, 12, 13, 14, 15, 16, 17, 18, 19, 20
- » 3/8" Insulated Extension Bar 75mm
- » 3/8" Insulated Extension Bar 150mm
- » 3/8" Insulated Ratchet

Item ID: **TEDV3818**



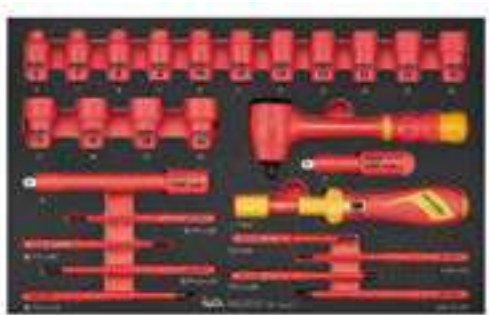

**INSULATED TORQUE SCREWDRIVER SET FOAM3 27 PIECES**



**CONTENTS**

- » 3/8" Insulated Socket
- » 6, 7, 8, 9, 10, 11, 12, 13, 14, 15, 16, 17, 18, 19, 20
- » Interchangeable Blade Insulated Screwdriver
- » 3, 4, 5.5, 6.5, PH1, PH2, PZ1, PZ2
- » 3/8" Insulated Extension Bar 75mm
- » 3/8" Insulated Extension Bar 150mm
- » 3/8" Insulated Ratchet
- » Insulated Torque Screwdriver 1-5Nm

Item ID: **TEFXV27**



**INSULATED SOCKET & SCREWDRIVER SET FOAM3 28 PIECES**



**CONTENTS**

- » 3/8" Insulated Socket
- » 6, 7, 8, 9, 10, 11, 12, 13, 14, 15, 16, 17, 18, 19, 20
- » Interchangeable Blade Insulated Screwdriver
- » 3, 4, 5.5, 6.5, PH1, PH2, PZ1, PZ2
- » 3/8" Insulated Extension Bar 75mm
- » 3/8" Insulated Extension Bar 150mm
- » Insulated Handle for Interchangeable Blades S
- » Insulated Handle for Interchangeable Blades L
- » 3/8" Insulated Ratchet

Item ID: **TEFXV28**



**NEW**

**INSULATED SPANNER SET FOAM2 12 PIECES**



**CONTENTS**

- » Insulated Spanner
- » 8, 9, 10, 11, 12, 13, 14, 15, 16, 17, 18, 19

Item ID: **TEDVSP12**







**NEW**



**INSULATED SOCKET & SPANNER SET FOAM3 19 PIECES**



**CONTENTS**

- » 3/8" Insulated Socket
- » 8, 9, 10, 11, 12, 13, 14, 15, 17, 18, 19, 20
- » Insulated Long Nose Plier Bent 210mm
- » 3/8" Insulated Extension Bar 75mm
- » 3/8" Insulated Extension Bar 150mm
- » Insulated Wire Stripping Plier
- » Insulated Combination Plier 185mm
- » 3/8" Insulated Ratchet
- » Insulated Side Cutting Plier 160mm

Item ID: **TEFSKV19**



**NEW**

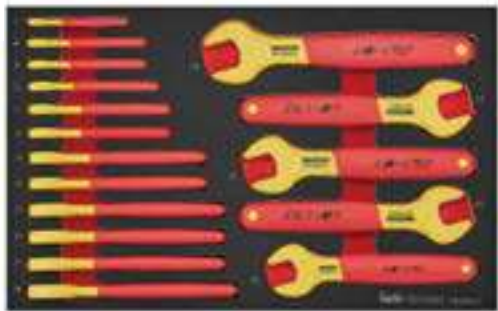

**INSULATED SPANNER SET FOAM3 17 PIECES**



**CONTENTS**

- » Insulated Spanner
- » 7, 8, 9, 10, 11, 12, 13, 14, 15, 16, 17, 18, 19, 20, 21, 22, 24

Item ID: **TEFSPV17**



**NEW**



**CUTTING TOOL SET FOAM2 6 PIECES**

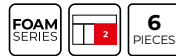

**CONTENTS**

- » Scissors 5-1/2"
- » Compact tin snip straight cut Cr-Mo 190mm
- » Compact tin snip straight/right cut Cr-Mo 182mm
- » Compact tin snip straight/left cut Cr-Mo 182mm
- » Deburring Tool Pocket Clip
- » Scriber With Carbide Tip

Item ID: **TEDCT06**



**MEASURING TOOL SET FOAM2 3 PIECES**

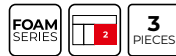

**CONTENTS**

- » Dial Gauge with Magnetic Stand 0-25mm
- » Micrometer 0 - 25mm
- » Digital Caliper 0-150mm

Item ID: **TEDIMM**







**3/8" T BAR SPARK PLUG SOCKET SET FOAMX4 5 PIECES**



**CONTENTS**

- » 3/8" T-Bar Spark Plug Socket (Magnetic)  
14, 16, 21
- » T Bar for T Bar Sockets

Item ID: **TEXTB05**



**PUNSCH & CHISEL SET FOAM2 14 PIECES**

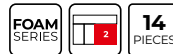

**CONTENTS**

- » Parallel Pin Punch  
3, 4, 5, 6, 7, 8
- » Centre Punch  
4, 5, 8
- » Flat Cold Chisel  
18, 25 (x2), 26
- » Automatic Centre Punch

Item ID: **TEDPC14**



**WHEEL TOOL SET FOAMX4 5 PIECES**



**CONTENTS**

- » 1/2" Impact Socket Wheel Nut  
17, 19, 21
- » 1/2" Impact Extension Bar ANSI 125mm
- » 1/2" Breaker Bar 450 mm DIN3122

Item ID: **TEXW05**



**PRY BAR SET ROLL/HEEL FOAMX4 4 PIECES**



**CONTENTS**

- » Pry Bar Roll Heel Type 400mm
- » Pry Bar Roll Heel Type 500mm
- » Pry Bar Roll Heel Type 300 mm
- » Tyre Lever 500mm

Item ID: **TEXPB4**





NEW



**RIVET GUN SET FOAM1 81 PIECES**



CONTENTS

- » Hand Rivet Gun Aluminium Alloy 2.4/3.2/4.0/4.8mm

Item ID: **TEAHR81**



**CLIP & PANEL REMOVER SET FOAM1 4 PIECES**

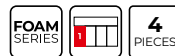

CONTENTS

- » Trim clip removal tool V-shape
- » Trim clip removal tool V-shape large
- » Panel clip removal tool U-shape large
- » Panel clip removal tool U-shape

Item ID: **TEASR04A**



**EXTRACTOR AND NUT SPLITTER SET FOAMX2 6 PIECES**



CONTENTS

- » Nut Splitter Set 2 Pieces
- » 1/2" Stud Extractor Socket
- » 6, 8, 10, 12

Item ID: **TEZSN06**



# OTHER TOOL SETS

## A VARIETY OF TOOL SETS INCLUDING PORTABLE SOLUTIONS AND WALL RACKS

A portable tool kit can be a convenient, organised, space-saving, versatile, and cost-effective option for people who need to take their tools with them or have limited storage space



A comprehensive range of tool holders that are ideal to attach to tool panels above a bench or to mount directly on the wall. The holders are perfect for the storage of tools you use frequently, they create order and make the tools easy to reach.





**TOOL SET HEAVY DUTY VEHICLE 105 PIECES**

- Combination Spanner Metric
- 8, 10, 11, 12, 13, 14, 15, 16, 17, 18, 19, 21, 22, 24, 25, 26, 27, 30, 32
- 1/2" Hex Bit Socket Metric
- 5, 6, 7, 8, 10, 12, 14, 17, 19
- Ball Pein Hammer 24oz
- Telescopic Magnetic Pick Up Tool And Pen
- 1/2" Socket 6 pt Metric
- 8, 10, 12, 13, 14, 15, 16, 17, 18, 19, 21, 22, 24, 25, 26, 27, 30, 32
- Hook Tool 125°
- Ball Point Hex Key Metric 7mm
- 1/2" Ratchet FRP 45 Teeth
- Quick Set Water Pump Plier HRC60 250mm
- Ball Point Hex Key Set 9 Pieces
- 1/2" Extension Bar 125mm
- Adjustable Wrench 300mm
- Adjustable Wrench 150mm
- 1/4" Ratcheting Bits Driver Set
- Heavy Duty Combination Plier 185mm
- Bit Set With Belt Clip Mixed 29 Pieces
- 1/2" Breaker Bar 450 mm DIN3122
- Side Cutting Plier 160mm
- Flat Screwdriver 0.5 x 2.5 x 75mm S

Item ID: **THDV105**



**TOOL SET HEAVY DUTY VEHICLE ENGINEERS HAMMER 105 PIECES**

- Combination Spanner Metric
- 8, 10, 11, 12, 13, 14, 15, 16, 17, 18, 19, 21, 22, 24, 25, 26, 27, 30, 32
- 1/2" Hex Bit Socket Metric
- 5, 6, 7, 8, 10, 12, 14, 17, 19
- Engineers Hammer 800g
- Telescopic Magnetic Pick Up Tool And Pen
- 1/2" Socket 6 pt Metric
- 8, 10, 12, 13, 14, 15, 16, 17, 18, 19, 21, 22, 24, 25, 26, 27, 30, 32
- Hook Tool 125°
- Ball Point Hex Key Metric 7mm
- 1/2" Ratchet FRP 45 Teeth
- Quick Set Water Pump Plier HRC60 250mm
- Ball Point Hex Key Set 9 Pieces
- 1/2" Extension Bar 125mm
- Adjustable Wrench 300mm
- Adjustable Wrench 150mm
- 1/4" Ratcheting Bits Driver Set
- Heavy Duty Combination Plier 185mm
- Bit Set With Belt Clip Mixed 29 Pieces
- 1/2" Breaker Bar 450 mm DIN3122
- Side Cutting Plier 160mm
- Flat Screwdriver 0.5 x 2.5 x 75mm S

Item ID: **THDV105E**

**105**  
PIECES

**105**  
PIECES







### TOOL KIT 187 PIECES WITH MEGA ROSSO CARRYING BOX

187  
PIECES

- 1/4" Socket 6 pt Metric  
4, 5, 5.5, 6, 7, 8, 10, 11, 12, 13
- 1/2" Socket 12 pt Metric  
10, 11, 12, 13, 14, 15, 16, 17, 18, 19, 21, 22, 24, 27, 30, 32
- Reducing Adaptor 3/8"F - 1/4"M
- Reducing Adaptor 1/2"F - 3/8"M
- Combination Spanner Metric  
8, 10, 11, 12, 13, 14, 15, 17, 19
- 1/4" Extension Bar 50mm
- 1/4" Extension Bar 100mm
- 1/2" Universal Joint
- 1/4" Universal Joint
- 3/8" Universal Joint
- 3/8" Socket 6 pt Metric  
8, 9, 10, 11, 12, 13, 14, 15, 16, 17, 18, 19, 21, 22
- 1/4" Deep Socket 6 pt Metric  
6, 7, 8, 10, 12, 13
- Barn Style Tool Box
- 1/2" Ratchet FRP 45 Teeth
- Spanner Ring
- 3/8" Bit Adaptor Hex bit coupler 1/4" Hex
- Step Up Adaptor 3/8"F - 1/2"M
- 1/2" Extension Bar 63.5mm
- 1/2" Extension Bar 150mm
- 3/8" Extension Bar 150mm
- 1/4" Ratchet FRP 45 Teeth
- 1/4" Bit Adaptor Hex Bit Coupler
- 3/8" Ratchet FRP 45 Teeth

Item ID: **TC187**



### TOOL PANEL KIT 16 PIECES RED

16  
PIECES

- Adjustable Wrench 600mm
- Bolt Cutter 600mm
- Groove Joint Water Pump Plier 400mm
- Aluminium Pipe Wrench 450mm
- Magnetic Tool Rail
- Tool Hooks 7 x 90° & 3 x 45°
- Side Panel with Stand

Item ID: **TKP26R16**







**MOBILE TOOL PANEL TOOL KIT 33 PIECES**

- Combination Spanner Set 8-19 mm Wall Rack 12 Pieces
- Mobile Tool Panel 2 Panels
- T-Handle Ball Point Hex Key Set Wall Rack 7 Pieces
- Screwdriver Set Wall Rack 10 Pieces
- Plier Set Wall Rack 4 Pieces

Item ID: **TPT01**

**33**  
PIECES

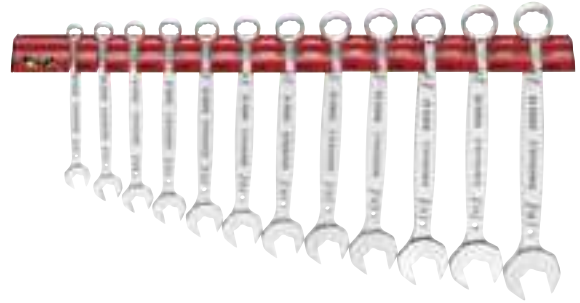

**12**  
PIECES **mm**

**SPANNER SET ANTI SLIP COMBINATION 12 PIECES WALL RACK**

- Combination Spanner Anti Slip Metric
- 8, 9, 10, 11, 12, 13, 14, 15, 16, 17, 18, 19

Item ID: **WR8012**



**12**  
PIECES **mm**

**SPANNER SET COMBINATION MM 12 PIECES WALL RACK**

- Combination Spanner Metric
- 8, 9, 10, 11, 12, 13, 14, 15, 16, 17, 18, 19

Item ID: **WRSP12**



12  
PIECES mm**SPANNER SET LONG COMBINATION 12 PIECES WALL RACK**

- Long Combination Spanner Metric
- 8, 9, 10, 11, 12, 13, 14, 15, 16, 17, 18, 19

Item ID: **WRSP12LMP**5  
PIECES mm**SPANNER SET LONG RING 5 PIECES WALL RACK**

- Long Double Ring Spanner Metric
- 8 x 10, 11 x 13, 12 x 14, 17 x 19, 22 x 24

Item ID: **WRFLS05**12  
PIECES mm**SPANNER SET RATCHET COMBINATION 12 PIECES WALL RACK**

- Ratcheting Combination Spanner Metric RS
- 8, 9, 10, 11, 12, 13, 14, 15, 16, 17, 18, 19

Item ID: **WRSP12RS**6  
PIECES mm**WRENCH SET DOUBLE FLEX 6 PIECES WALL RACK**

- Double Flex Wrench Metric
- 8 x 9, 10 x 11, 12 x 13, 14 x 15, 16 x 17, 18 x 19

Item ID: **WRDF06**

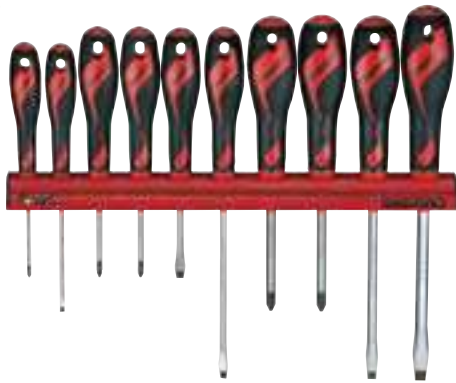

**SCREWDRIVER SET 10 PIECES WALL RACK**

- Flat Screwdriver  
0.5 x 3.0, 1.0 x 5.5 (x2), 1.2 x 6.5, 1.2 x 8.0
- PH Screwdriver  
PH0, PH1, PH2
- PZ Screwdriver  
PZ1, PZ2

Item ID: **WRMD10N**



**HEX KEY SET T HANDLE 7 PIECES WALL RACK**

- T Handle Ball Point Hex Key Metric  
2.5, 3, 4, 5, 6, 7, 8

Item ID: **WRHEX07**



**SCREWDRIVER SET 5 PIECES WALL RACK**

- PH Power Thru Screwdriver  
PH2, PH3
- Flat Power Thru Screwdriver  
1.2 x 6.5, 1.2 x 8, 1.6 x 10

Item ID: **WRMDT05N**



**HEX KEY SET T HANDLE 7 PIECES AF WALL RACK**

- T Handle Ball Point Hex Key AF  
1/4, 1/8, 3/16, 3/32, 5/16, 5/32, 7/32

Item ID: **WRHEX07AF**





**TX KEY SET T HANDLE 7 PIECES WALL RACK**

- T Handle Ball Point TX Key
- TX10, TX15, TX20, TX25, TX27, TX30, TX40

Item ID: **WRTX07**

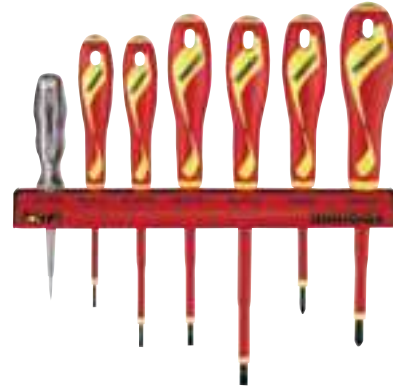

**SCREWDRIVER SET 1000 VOLT 7 PIECES WALL RACK**

- Flat Insulated Screwdriver
- 0,4 x 2,5, 0,5 x 3,0, 0,8 x 4,0, 1,0 x 5,5
- Voltage Tester
- PH Insulated Screwdriver
- PH1, PH2

Item ID: **WRMDV07N**



**PLIER SET 4 PIECES WALL RACK**

- Side Cutting Plier TPR Grip 160mm
- Water Pump Plier TPR Grip 250mm
- Heavy Duty Combination Plier TPR Grip 190mm
- Long Nose Plier TPR Grip 205mm

Item ID: **WRMB04**



**SCREWDRIVER SET 1000 VOLT 5 PIECES WALL RACK**

- Flat Insulated Screwdriver
- 0,5 x 3,0, 1,0 x 5,5
- PZ Insulated Screwdriver PZ2
- PH Insulated Screwdriver
- PH1, PH2

Item ID: **WRMDV05N**





**PLIER SET 1000 VOLT 4 PIECES WALL RACK**

- Insulated Long Nose Plier 215mm
- Insulated Side Cutting Plier 205mm
- Insulated Side Cutting Plier 160mm
- Insulated Combination Plier 185mm

Item ID: **WRMBV04**



**PUNCH AND CHISEL SET 10 PIECES WALL RACK**

- Parallel Pin Punch
- 3, 4, 5, 6, 7, 8
- Centre Punch 5mm
- Flat Cold Chisel
- 18, 25 (x2)

Item ID: **WRPC10**



**FILE SET 5 PIECES WALL RACK**

- Hand File 250mm Half round
- Hand File 250mm Round
- Hand File 250mm Triangular
- Hand File 250mm Flat Tapered
- Hand File 250mm Flat

Item ID: **WRFL05**









# PRO35™

## MADE FOR PROFESSIONALS

Introducing the next generation in tool storage, specifically designed to cater to the demands of professionals in automotive, maintenance, engineering, and motorsport. Crafted with a robust 3-piece heavy gauge steel cabinet frame and fortified with our advanced 5-step phosphate-free rust protection, they are built to last even in the toughest work environments.



**3-PIECE HEAVY GAUGE  
STEEL CABINET FRAME**



**5-STEP PHOSPHATE-FREE  
RUST PROTECTION**



**3-DIGIT  
COMBINATION LOCK**



**UP TO 40KG DRAWER  
LOADING CAPACITY**



**ALL DRAWERS COMPATIBLE  
WITH OUR MODULAR TOOL  
CONTROL SYSTEM**





Read more about product care and the TengTools Lifetime guarantee here:



# IMPROVED FEATURES



## 3-DIGIT COMBINATION LOCK

Flexible Security Options - Secure your tools with our multiple lock options. Switch between combination and key locks depending on your preference, keeping your tools safe and accessible.

## FLAT ALUMINIUM DRAWER FRONT HANDLES

Aluminum handles with space for labelling ensure you stay organised. Label your drawers to reflect the contents, tailored by you.



## NEW REINFORCED DRAWER DESIGN

Our drawers are engineered to fit TengTools Tool Control Modules seamlessly. Reinforced and capable of holding up to 40kg, they're built for heavy-duty use.

The drawers are tested pulling them out and pushing them in more than 35,000 times with maximum drawer load.





## FOAM WORKTOP MAT AS STANDARD.

Upgrade to hard-wearing laminated wood or sleek stainless-steel worktops. Available in multiple sizes for a perfect fit.



### COMFORT GRIP HANDLE

Ergonomically designed for ease of movement. When used with a side shelf it creates extra space for storing longer items conveniently at your side.



### EXTRA TOOL PROTECTION

FOAM mats supplied in each drawer to protect loose tools while being stored.

### FULL EXTENSION BALL BEARING SLIDES

Each drawer is fully extendable with ball bearing slides ensuring a smooth and reliable opening, and closing action every time.

### HEAVY-DUTY CASTORS

Navigate your workspace with ease using our robust castors. Supplied with two fixed and two swivel, with brakes for stability when you need it.

### RECESSED SIDE HANDLES (TOOL CHESTS)

Fold-down side handles with 150kg capacity each.





# PRO35™

## BOOST YOUR PERFORMANCE

Elevate your workspace with TengTools PRO35™ Series Tool Cabinets. These cabinets boast a host of enhanced features crafted to boost your performance. From reinforced drawer designs capable of holding up to 40kg to precision-engineered compatibility with our Tool Control System, every detail has been refined to ensure seamless functionality and unparalleled convenience. Say goodbye to cluttered workspaces and hello to streamlined productivity.





PRO35™



**11" PRO35™ TOOL CHEST 2 DRAWERS RED**

-  **2 Drawer**

 **3-Piece Cabinet Frame**
-  **5-Step Phosphate-Free Rust Protection**

 **Heavy Gauge Steel**

	Width (mm)	Depth (mm)	Height (mm)
Dimensions	310	210	190

Item ID: **TST11R2**







**26" PRO35™ TOOL CHEST 4 DRAWERS RED**

- 4 Drawer**
- 3-Step Ball Bearing Slides**
- 5-Step Phosphate-Free Rust Protection**
- Combination Lock As Standard**
- 26" Wide Box**
- Heavy Gauge Steel**
- Up To 30kg Drawer Loading Capacity**

	Width (mm)	Depth (mm)	Height (mm)	Capacity (Kg)
Dimensions	660	305	380	
Drawer 1	569	275	50	30
Drawer 2	569	275	50	30
Drawer 3	569	275	50	30
Drawer 4	569	275	75	30

Item ID: **TST26R4**



**26" PRO35™ TOOL CHEST 4 DRAWERS BLACK**

- 4 Drawer**
- 3-Step Ball Bearing Slides**
- 5-Step Phosphate-Free Rust Protection**
- Combination Lock As Standard**
- 26" Wide Box**
- Heavy Gauge Steel**
- Up To 30kg Drawer Loading Capacity**

	Width (mm)	Depth (mm)	Height (mm)	Capacity (Kg)
Dimensions	660	305	380	
Drawer 1	569	275	50	30
Drawer 2	569	275	50	30
Drawer 3	569	275	50	30
Drawer 4	569	275	75	30

Item ID: **TST26B4**





**26" PRO35™ TOOL CHEST 4 DRAWERS BLACK WITH CUSTOM STICKER**

- 4 Drawer**
- 3-Step Ball Bearing Slides**
- 5-Step Phosphate-Free Rust Protection**
- Combination Lock As Standard**
- 26" Wide Box**
- Heavy Gauge Steel**
- Up To 30kg Drawer Loading Capacity**

	Width (mm)	Depth (mm)	Height (mm)	Capacity (Kg)
Dimensions	660	305	380	
Drawer 1	569	275	50	30
Drawer 2	569	275	50	30
Drawer 3	569	275	50	30
Drawer 4	569	275	75	30

Item ID: **TST26B4P**



**26" PRO35™ DEEP TOOL CHEST 5 DRAWERS RED**

- 5 Drawer**
- 3-Step Ball Bearing Slides**
- 5-Step Phosphate-Free Rust Protection**
- Combination Lock As Standard**
- 26" Wide Box**
- Heavy Gauge Steel**
- Up To 30kg Drawer Loading Capacity**

	Width (mm)	Depth (mm)	Height (mm)	Capacity (Kg)
Dimensions	660	455	483	
Drawer 1	575	380	50	30
Drawer 2	575	380	50	30
Drawer 3	575	380	75	30
Drawer 4	575	380	75	30
Drawer 5	575	380	75	30

Item ID: **TST26R5F**





**26" PRO35™ TOOL CHEST 3 DRAWERS RED**

- 3 Drawer**
- 26" Wide Box**
- 3-Step Ball Bearing Slides**
- Heavy Gauge Steel**
- 5-Step Phosphate-Free Rust Protection**
- Up To 30kg Drawer Loading Capacity**
- Combination Lock As Standard**

	Width (mm)	Depth (mm)	Height (mm)	Capacity (Kg)
Dimensions	660	305	250	
Drawer 1	569	275	50	30
Drawer 2	569	275	50	30
Drawer 3	569	275	75	30

Item ID: **TSM26R3**



**26" PRO35™ TOOL CHEST 3 DRAWERS BLACK**

- 3 Drawer**
- 26" Wide Box**
- 3-Step Ball Bearing Slides**
- Heavy Gauge Steel**
- 5-Step Phosphate-Free Rust Protection**
- Up To 30kg Drawer Loading Capacity**
- Combination Lock As Standard**

	Width (mm)	Depth (mm)	Height (mm)	Capacity (Kg)
Dimensions	660	305	250	
Drawer 1	569	275	50	30
Drawer 2	569	275	50	30
Drawer 3	569	275	75	30

Item ID: **TSM26B3**





**37" PRO35™ TOOL CHEST 5 DRAWERS RED**

- 5 Drawer**
- 3-Step Ball Bearing Slides**
- 5-Step Phosphate-Free Rust Protection**
- Combination Lock As Standard**
- 37" Wide Box**
- Heavy Gauge Steel**
- Up To 25kg Drawer Loading Capacity**

	Width (mm)	Depth (mm)	Height (mm)	Capacity (Kg)
Dimensions	945	455	483	
Drawer 1	860	380	50	25
Drawer 2	860	380	50	25
Drawer 3	860	380	75	25
Drawer 4	860	380	75	25
Drawer 5	860	380	75	25

Item ID: **TST37R5F**



**53" PRO35™ TOOL CHEST 10 DRAWERS RED**

- 10 Drawer**
- 3-Step Ball Bearing Slides**
- 5-Step Phosphate-Free Rust Protection**
- Combination Lock As Standard**
- 53" Wide Box**
- Heavy Gauge Steel**
- Up To 40kg Drawer Loading Capacity**

	Width (mm)	Depth (mm)	Height (mm)	Capacity (Kg)
Dimensions	1337	455	560	
Drawer 1	575	380	75	40
Drawer 2	575	380	75	40
Drawer 3	575	380	75	40
Drawer 4	575	380	75	40
Drawer 5	575	380	75	40
Drawer 6	575	380	75	40
Drawer 7	575	380	75	40
Drawer 8	575	380	75	40
Drawer 9	575	380	75	40
Drawer 10	575	380	75	40

Item ID: **TST53R10F**





**26" PRO35™ LOW ROLLER CABINET 4 DRAWERS RED**

- 4 Drawer**
- 26" Wide Box**
- 3-Piece Cabinet Frame**
- Heavy Gauge Steel**
- 5-Step Phosphate-Free Rust Protection**
- Up To 40kg Drawer Loading Capacity**
- 3-Step Ball Bearing Slides**
- Comfort Grip Handle**
- Combination Lock As Standard**
- 4" x 1-1/4" Castor Wheels**

	Width (mm)	Depth (mm)	Height (mm)	Height Inc Wheels	Capacity (Kg)
Dimensions	680	460	656	770	
Drawer 1	575	380	75		40
Drawer 2	575	380	75		40
Drawer 3	575	380	75		40
Drawer 4	575	380	312		40

Item ID: **TSW26R4L**



**26" PRO35™ LOW ROLLER CABINET 6 DRAWERS RED**

- 6 Drawer**
- 26" Wide Box**
- 3-Piece Cabinet Frame**
- Heavy Gauge Steel**
- 5-Step Phosphate-Free Rust Protection**
- Up To 40kg Drawer Loading Capacity**
- 3-Step Ball Bearing Slides**
- Comfort Grip Handle**
- Combination Lock As Standard**
- 4" x 1-1/4" Castor Wheels**

	Width (mm)	Depth (mm)	Height (mm)	Height Inc Wheels	Capacity (Kg)
Dimensions	680	460	656	770	
Drawer 1	575	380	75		40
Drawer 2	575	380	75		40
Drawer 3	575	380	75		40
Drawer 4	575	380	75		40
Drawer 5	575	380	75		40
Drawer 6	575	380	154		40

Item ID: **TSW26R6L**





PRO35™



**26" PRO35™ ROLLER CABINET 6 DRAWERS RED**

- 6 Drawer**
- 26" Wide Box**
- 3-Piece Cabinet Frame**
- Heavy Gauge Steel**
- 5-Step Phosphate-Free Rust Protection**
- Up To 40kg Drawer Loading Capacity**
- 3-Step Ball Bearing Slides**
- Comfort Grip Handle**
- Combination Lock As Standard**
- 5" x 1-1/4" Castor Wheels**

	Width (mm)	Depth (mm)	Height (mm)	Height Inc Wheels	Capacity (Kg)
Dimensions	680	460	813	960	
Drawer 1	575	380	75		40
Drawer 2	575	380	75		40
Drawer 3	575	380	75		40
Drawer 4	575	380	75		40
Drawer 5	575	380	75		40
Drawer 6	575	380	312		40

Item ID: **TSW26R6**



PRO35™



**26" PRO35™ ROLLER CABINET 7 DRAWERS RED**

- 7 Drawer**
- 26" Wide Box**
- 3-Piece Cabinet Frame**
- Heavy Gauge Steel**
- 5-Step Phosphate-Free Rust Protection**
- Up To 40kg Drawer Loading Capacity**
- 3-Step Ball Bearing Slides**
- Comfort Grip Handle**
- Combination Lock As Standard**
- 5" x 1-1/4" Castor Wheels**

	Width (mm)	Depth (mm)	Height (mm)	Height Inc Wheels	Capacity (Kg)
Dimensions	680	460	813	960	
Drawer 1	575	380	75		40
Drawer 2	575	380	75		40
Drawer 3	575	380	75		40
Drawer 4	575	380	75		40
Drawer 5	575	380	75		40
Drawer 6	575	380	154		40
Drawer 7	575	380	154		40

Item ID: **TSW26R7**







**PRO35™**



**26" PRO35™ ROLLER CABINET 9 DRAWERS RED**

- 9 Drawer**
- 3-Piece Cabinet Frame**
- 5-Step Phosphate-Free Rust Protection**
- 3-Step Ball Bearing Slides**
- Combination Lock As Standard**
- 26" Wide Box**
- Heavy Gauge Steel**
- Up To 40kg Drawer Loading Capacity**
- Comfort Grip Handle**
- 5" x 1-1/4" Castor Wheels**

	Width (mm)	Depth (mm)	Height (mm)	Height Inc Wheels	Capacity (Kg)
Dimensions	680	460	813	960	
Drawer 1	575	380	75		40
Drawer 2	575	380	75		40
Drawer 3	575	380	75		40
Drawer 4	575	380	75		40
Drawer 5	575	380	75		40
Drawer 6	575	380	75		40
Drawer 7	575	380	75		40
Drawer 8	575	380	75		40
Drawer 9	575	380	75		40



**PRO35™**



**26" PRO35™ ROLLER CABINET 9 DRAWERS BLACK**

- 9 Drawer**
- 3-Piece Cabinet Frame**
- 5-Step Phosphate-Free Rust Protection**
- 3-Step Ball Bearing Slides**
- Combination Lock As Standard**
- 26" Wide Box**
- Heavy Gauge Steel**
- Up To 40kg Drawer Loading Capacity**
- Comfort Grip Handle**
- 5" x 1-1/4" Castor Wheels**

	Width (mm)	Depth (mm)	Height (mm)	Height Inc Wheels	Capacity (Kg)
Dimensions	680	460	813	960	
Drawer 1	575	380	75		40
Drawer 2	575	380	75		40
Drawer 3	575	380	75		40
Drawer 4	575	380	75		40
Drawer 5	575	380	75		40
Drawer 6	575	380	75		40
Drawer 7	575	380	75		40
Drawer 8	575	380	75		40
Drawer 9	575	380	75		40

Item ID: **TSW26R9**

Item ID: **TSW26B9**





PRO35™



PRO35™



**37" PRO35™ ROLLER CABINET 7 DRAWERS RED**

- 7** Drawer
- 37" Wide Box**
- 3-Piece Cabinet Frame**
- Heavy Gauge Steel**
- 5-Step Phosphate-Free Rust Protection**
- Up To 40kg Drawer Loading Capacity**
- 3-Step Ball Bearing Slides**
- Comfort Grip Handle**
- Combination Lock As Standard**
- 5" x 2" Castor Wheels**

	Width (mm)	Depth (mm)	Height (mm)	Height Inc Wheels	Capacity (Kg)
Dimensions	964	460	813	985	
Drawer 1	860	380	75		25
Drawer 2	860	380	75		25
Drawer 3	860	380	75		25
Drawer 4	860	380	75		25
Drawer 5	860	380	75		25
Drawer 6	860	380	154		40
Drawer 7	860	380	154		40

Item ID: **TSW37R7**

**37" PRO35™ ROLLER CABINET 8 DRAWERS BLACK**

- 8** Drawer
- 37" Wide Box**
- 3-Piece Cabinet Frame**
- Heavy Gauge Steel**
- 5-Step Phosphate-Free Rust Protection**
- Up To 40kg Drawer Loading Capacity**
- 3-Step Ball Bearing Slides**
- Comfort Grip Handle**
- Combination Lock As Standard**
- 5" x 2" Castor Wheels**

	Width (mm)	Depth (mm)	Height (mm)	Height Inc Wheels	Capacity (Kg)
Dimensions	964	460	813	985	
Drawer 1	860	380	75		25
Drawer 2	860	380	75		25
Drawer 3	860	380	75		25
Drawer 4	860	380	75		25
Drawer 5	860	380	75		25
Drawer 6	860	380	75		25
Drawer 7	860	380	75		25
Drawer 8	860	380	154		40

Item ID: **TSW37B8**





**PRO35™**



**53" PRO35™ ROLLER CABINET 9 DRAWERS RED**

-  **9 Drawer**
-  **3-Piece Cabinet Frame**
-  **5-Step Phosphate-Free Rust Protection**
-  **3-Step Ball Bearing Slides**
-  **Combination Lock As Standard**
-  **53" Wide Box**
-  **Heavy Gauge Steel**
-  **Up To 40kg Drawer Loading Capacity**
-  **Comfort Grip Handle**
-  **6" x 2" Castor Wheels**

	Width (mm)	Depth (mm)	Height (mm)	Height Inc Wheels	Capacity (Kg)
Dimensions	1350	460	813	993	
Drawer 1	1215	380	160		40
Drawer 2	575	380	75		40
Drawer 3	575	380	75		40
Drawer 4	575	380	75		40
Drawer 5	575	380	75		40
Drawer 6	575	380	75		40
Drawer 7	575	380	75		40
Drawer 8	575	380	154		40
Drawer 9	575	380	154		40

Item ID: **TSW53R9**













PRO35™



**64" PRO35™ ROLLER CABINET 15 DRAWERS RED**

-  **15 Drawer**
-  **3-Piece Cabinet Frame**
-  **5-Step Phosphate-Free Rust Protection**
-  **3-Step Ball Bearing Slides**
-  **Combination Lock As Standard**
-  **64" Wide Box**
-  **Heavy Gauge Steel**
-  **Up To 40kg Drawer Loading Capacity**
-  **Comfort Grip Handle**
-  **6" x 2" Castor Wheels**

Item ID: **TSW64R15**

	Width (mm)	Depth (mm)	Height (mm)	Height Inc Wheels	Capacity (Kg)
Dimensions	1640	460	974	1153	
Drawer 1	1215	380	75		40
Drawer 2	575	380	75		40
Drawer 3	575	380	75		40
Drawer 4	575	380	75		40
Drawer 5	575	380	75		40
Drawer 6	575	380	75		40
Drawer 7	575	380	312		40
Drawer 8	860	380	75		25
Drawer 9	860	380	75		25
Drawer 10	860	380	75		25
Drawer 11	860	380	75		25
Drawer 12	860	380	75		25
Drawer 13	860	380	75		25
Drawer 14	860	380	154		40
Drawer 15	860	380	154		40





**PRO35™**



**PRO35™**



**26" PRO35™ STACK TOOL STORAGE 16 DRAWERS RED**

- 16 Drawer
- 26" Wide Box
- 3-Piece Cabinet Frame
- Heavy Gauge Steel
- 5-Step Phosphate-Free Rust Protection
- Up To 40kg Drawer Loading Capacity
- 3-Step Ball Bearing Slides
- Comfort Grip Handle
- Combination Lock As Standard
- 5" x 1-1/4" Castor Wheels

**26" PRO35™ STACK TOOL STORAGE 16 DRAWERS BLACK**

- 16 Drawer
- 26" Wide Box
- 3-Piece Cabinet Frame
- Heavy Gauge Steel
- 5-Step Phosphate-Free Rust Protection
- Up To 40kg Drawer Loading Capacity
- 3-Step Ball Bearing Slides
- Comfort Grip Handle
- Combination Lock As Standard
- 5" x 1-1/4" Castor Wheels

**Contents:**

Item ID	Description
TST26R4	26" PRO35™ Tool Chest 4 Drawers Red
TSM26R3	26" PRO35™ Tool Chest 3 Drawers Red
TSW26R9	26" PRO35™ Roller Cabinet 9 Drawers Red

**Contents:**

Item ID	Description
TST26B4	26" PRO35™ Tool Chest 4 Drawers Black
TSM26B3	26" PRO35™ Tool Chest 3 Drawers Black
TSW26B9	26" PRO35™ Roller Cabinet 9 Drawers Black

Item ID: **TSS26R16**

Item ID: **TSS26B16**





PRO35™



**37" PRO35™ STACK TOOL STORAGE 12 DRAWERS RED**

- 12 Drawer
- 37" Wide Box
- 3-Piece Cabinet Frame
- Heavy Gauge Steel
- 5-Step Phosphate-Free Rust Protection
- Up To 40kg Drawer Loading Capacity
- 3-Step Ball Bearing Slides
- Comfort Grip Handle
- Combination Lock As Standard
- 5" x 2" Castor Wheels

**Contents:**

Item ID	Description
TST37R5F	37" PRO35™ Tool Chest 5 Drawers Red
TSW37R7	37" PRO35™ Roller Cabinet 7 Drawers Red

Item ID: **TSS37R12**



PRO35™



**53" PRO35™ STACK TOOL STORAGE 19 DRAWERS RED**

- 19 Drawer
- 53" Wide Box
- 3-Piece Cabinet Frame
- Heavy Gauge Steel
- 5-Step Phosphate-Free Rust Protection
- Up To 40kg Drawer Loading Capacity
- 3-Step Ball Bearing Slides
- Comfort Grip Handle
- Combination Lock As Standard
- 6" x 2" Castor Wheels

**Contents:**

Item ID	Description
TST53R10F	53" PRO35™ Tool Chest 10 Drawers Red
TSW53R9	53" PRO35™ Roller Cabinet 9 Drawers Red

Item ID: **TSS53R19**







CLASSIC™



26" CLASSIC TOOL CHEST 4 DRAWER RED

- 4 Drawer**
- 26" Wide Box**
- 3-Step Ball Bearing Slides**
- Heavy Gauge Steel**
- 5-Step Phosphate-Free Rust Protection**
- Up To 30kg Drawer Loading Capacity**
- Key Lock**

	Width (mm)	Depth (mm)	Height (mm)	Capacity (Kg)
Dimensions	660	305	380	
Drawer 1	569	275	50	30
Drawer 2	569	275	50	30
Drawer 3	569	275	50	30
Drawer 4	569	275	75	30

Item ID: **TC804EV**

CLASSIC™



26" CLASSIC FULL DEPTH TOOL CHEST 5 DRAWERS RED

- 5 Drawer**
- 26" Wide Box**
- 3-Step Ball Bearing Slides**
- Heavy Gauge Steel**
- 5-Step Phosphate-Free Rust Protection**
- Up To 30kg Drawer Loading Capacity**
- Key Lock**

	Width (mm)	Depth (mm)	Height (mm)	Capacity (Kg)
Dimensions	660	455	483	
Drawer 1	575	380	50	30
Drawer 2	575	380	50	30
Drawer 3	575	380	75	30
Drawer 4	575	380	75	30
Drawer 5	575	380	75	30

Item ID: **TC805SV**





## CLASSIC™

**26" CLASSIC TOOL CHEST 3 DRAWERS RED**

- 3 Drawer**
- 3-Step Ball Bearing Slides**
- 5-Step Phosphate-Free Rust Protection**
- Key Lock**
- 26" Wide Box**
- Heavy Gauge Steel**
- Up To 30kg Drawer Loading Capacity**

	Width (mm)	Depth (mm)	Height (mm)	Capacity (Kg)
Dimensions	660	305	250	
Drawer 1	569	275	50	30
Drawer 2	569	275	50	30
Drawer 3	569	275	75	30

Item ID: **TC803SV**

## CLASSIC™

**26" CLASSIC CABINET 7 DRAWERS RED**

- 7 Drawer**
- 3-Piece Cabinet Frame**
- 5-Step Phosphate-Free Rust Protection**
- 3-Step Ball Bearing Slides**
- Key Lock**
- 26" Wide Box**
- Heavy Gauge Steel**
- Up To 30kg Drawer Loading Capacity**
- 5" x 1-1/4" Castor Wheels**

	Width (mm)	Depth (mm)	Height (mm)	Height Inc Wheels	Capacity (Kg)
Dimensions	680	460	813	960	
Drawer 1	575	380	75		30
Drawer 2	575	380	75		30
Drawer 3	575	380	75		30
Drawer 4	575	380	75		30
Drawer 5	575	380	75		30
Drawer 6	575	380	154		30
Drawer 7	575	380	154		30

Item ID: **TCW707EV**



**26" PRO CABINET 7 SOFT CLOSE DRAWERS RED**

- 7 Drawer**
- 3-Piece Cabinet Frame**
- 5-Step Phosphate-Free Rust Protection**
- 3-Step Ball Bearing Slides**
- Combination Lock As Standard**
- 26" Wide Box**
- Heavy Gauge Steel**
- Up To 30kg Drawer Loading Capacity**
- Comfort Grip Handle**
- 5" x 1-1/4" Castor Wheels**

	Width (mm)	Depth (mm)	Height (mm)	Height Inc Wheels	Capacity (Kg)
Dimensions	670	460	813	960	
Drawer 1	575	380	75		30
Drawer 2	575	380	75		30
Drawer 3	575	380	75		30
Drawer 4	575	380	75		30
Drawer 5	575	380	75		30
Drawer 6	575	380	150		30
Drawer 7	575	380	150		30

Item ID: **TCW907X**



**PRO35™**



**15" PRO35™ SIDE CABINET 1 DRAWER RED**

	Width (mm)	Depth (mm)	Height (mm)
Dimensions	382	460	795

Item ID: **TSC15R1**



**PRO35™**



**15" PRO35™ SIDE CABINET 7 DRAWERS RED**

	Width (mm)	Depth (mm)	Height (mm)
Dimensions	382	460	795

Item ID: **TSC15R7**





**PRO35™**



**PRO35™ SIDE CUPBOARD RED**

	Width (mm)	Depth (mm)	Height (mm)
Dimensions	400	200	500

Item ID: **TSC8RID**



**PRO35™**



**15" PRO35™ SIDE CABINET WITH DOOR RED**

	Width (mm)	Depth (mm)	Height (mm)
Dimensions	382	460	795

Item ID: **TSC15RID**



\*Tools not included

**TC4 CARRYING CASE**

	Width (mm)	Depth (mm)	Height (mm)
Dimensions	662	295	63

Item ID: **TC-4**

**SPARE STRAPS FOR TC-4**

Item ID: **TC-4SBL**



**MECCA PRO™**



**MECCA PRO TC9 SERVICE CASE**

	Width (mm)	Depth (mm)	Height (mm)
Dimensions	560	390	200

Item ID: **TC-SC**





MECCA PRO™



**MECCA PRO TC-6 CARRYING CASE**

	Width (mm)	Depth (mm)	Height (mm)
Dimensions	468	350	130

Item ID: **TC-6T**



**PLASTIC TOOL BOX**

	Width (mm)	Depth (mm)	Height (mm)
Dimensions	445	240	202

Item ID: **TCP445C**



**BARN STYLE TOOL BOX**

	Width (mm)	Depth (mm)	Height (mm)
Dimensions	450	200	200

Item ID: **TC450**



**BACK PACK TOOL BOX**

	Width (mm)	Depth (mm)	Height (mm)
Dimensions	380	230	430

Item ID: **TCSB**





**TOOL BAG**

	Width (mm)	Depth (mm)	Height (mm)
Dimensions	430	280	330

Item ID: **TCSB16**



**CANTILEVER TOOL BOX**

	Width (mm)	Depth (mm)	Height (mm)
Dimensions	570	220	340

Item ID: **TC540**



**TOP BOX COVER RED**

- Protective cover with the TengTools logo
- Fits TengTools 26" top boxes

Item ID: **TC-COVER**



**CABINET COVER RED**

- Protective cover with the TengTools logo
- Fits TengTools 26" roller cabinets

Item ID: **TC-WC02**







**STACK COVER RED**

- Protective cover with the TengTools logo
- Fits TengTools 26" stacks

Item ID: **TC-COVER1**



**NON SLIP MAT ROLL**

	Length (mm)	Width (mm)	Thickness (mm)
Dimensions	2000	450	2

Item ID: **TC-MAT**



**TOTE TRAY**

	Width (mm)	Depth (mm)	Height (mm)
Dimensions	476	204	89

Item ID: **TCA05**



**DIVIDER SET SMALL**

- Interlocking black metal dividers for use in top box size drawers
- A simple way to create a drawer with 9 separate compartments

Item ID: **TCDIVS**





**DIVIDER SET LARGE**

- Interlocking black metal dividers for use in roller cabinet size drawers
- A simple way to create a drawer with 9 separate compartments

Item ID: **TCDIVL**



**TOOL BOX FIXING BRACKETS**

Item ID:	Suitable for	No. of Pieces
TCF01	26" Wide Middle Box - 8 Series & CLASSIC	2
TCF02	26" Top Box - 8 Series & CLASSIC	2
TCF03	53" Top Box - 8 Series & CLASSIC	2
TCF04	26" & 37" Deep Top Box - 8 Series & CLASSIC	2
TCF05	26" 3-Drawer PRO35™ Tool Chest	2
TCF06	26" 4-Drawer PRO35™ Tool Chest	2
TCF07	26", 37", 53" PRO35™ Deep Tool Chest	2



**MAGNETIC RACK FOR TYRE TOOLS**

- Designed to take 4 sockets, torque wrench and an air wrench

Item ID: **BDIS-TYR**





**MAGNETIC TRAY RED**

Item ID:	Width (mm)	Depth (mm)	Height (mm)	No. of Magnets
580K	230	98	136	2
580M	460	98	136	4
580N	640	98	136	6

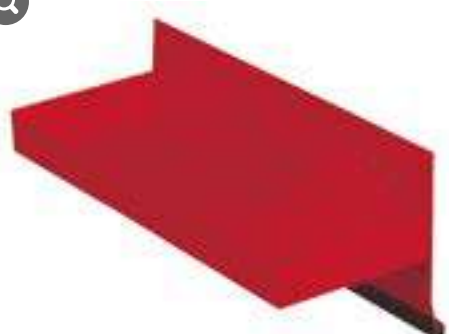

**MAGNETIC SHELF RED**

Item ID:	Width (mm)	Depth (mm)	Height (mm)
580C	310	115	31
580D	210	115	31



**MAGNETIC TRAY FOR CANS RED**

Item ID:	Width (mm)	Depth (mm)	Height (mm)	No. of Can Holders
580CK	230	98	136	2
580CM	460	98	136	4
580CN	640	98	136	6



**MAGNETIC SIDE SHELF RED**

Item ID:	Width (mm)	Depth (mm)	Height (mm)
580J	410	90	100





\*Paper roll not included

**PAPER ROLL HOLDER**

	Width (mm)	Depth (mm)
Dimensions	370	370

Item ID: **TCA01**



**SIDE SHELF FOR VICE**

	Width (mm)	Depth (mm)	Height (mm)
Dimensions	385	203	166

Item ID: **TCATV**



\*Paper roll not included

**PAPER ROLL HOLDER FOR SIDE HANDLE**

	Width (mm)
Dimensions	360

Item ID: **TCA08**



**POWER TOOL SHELF**

	Width (mm)	Depth (mm)	Height (mm)
Dimensions	375	280	55

Item ID: **TCATP**





**SIDE SHELF FOR ROLLER CABINET 457 X 100 X 50MM**

	Width (mm)	Depth (mm)	Height (mm)
Dimensions	457	100	50

Item ID: **580T**



**CABLE TIE HOLDER TOOL CHEST ACCESSORY**

	Width (mm)	Depth (mm)	Height (mm)
Dimensions	203	53	275

Item ID: **TCCTH**



**CABLE HOOK TOOL CABINET ACCESSORY**

	Width (mm)	Depth (mm)	Height (mm)
Dimensions	20	100	160

Item ID: **TCCH**



**MAGNETS WITH ADHESIVE TAPE 2 PIECES**

- 3M adhesive backing tape for reliable and long-lasting attachment.
- Suitable for holding a variety of items, such as power strips, offering convenience in various professional settings.
- Rubber-coating protects the paint on your TengTools tool cabinet from scratches.
- Compatible with any TengTools tool cabinet.

Item ID: **TC-MAG1**





**MAGNETIC TOOL RAIL**

- 6 individual magnets each with a capacity of 450g
- Designed to fix to the side of TengTools roller cabinets
- Also suitable for wall mounting or for use with other tool boxes
- Ideal for hanging up tools while working

Item ID: **TC-MAG**

**REPLACEMENT LOCKS**

Which lock to choose?

**CLASSIC™**

Item ID:	Description
TCDRK	Tool Box Spare Bar Type Key Lock
TCPRK	Tool Box Spare Regular Type Key Lock

Tool Box	Description	Key Lock
TC804EV	26" Classic Tool Chest 4 Drawer Red	TCPRK
TC805SV	26" Classic Full Depth Tool Chest 5 Drawers Red	TCPRK
TC803SV	26" Classic Tool Chest 3 Drawers Red	TCDRK
TCW707EV	26" Classic Cabinet 7 Drawers Red	TCDRK
TSC8R1D	PRO35™ Side Cupboard Red	TCPRK

**REPLACEMENT LOCKS**

Which lock to choose?

**PRO35™**

**ALL PRO35™ STORAGE (EXCEPT TSC8R1) CAN BE FITTED WITH A COMBINATION LOCK OR KEY LOCK**

Item ID:	Description
TC-90CLOCK	Tool Box Spare Combination Lock 90°
TC-90KEYLOCK	Key lock for TengTools storage, can replace the combination lock (TC-90CLOCK). Key turns 90°.
TC-180CLOCK	Tool Box Spare Combination Lock 180°
TC-180KEYLOCK	Key lock for TengTools storage, can replace the combination lock (TC-180CLOCK). Key turns 180°.

Tool Box	Description	Combination Lock	Key Lock
TSC15R1	15" PRO35™ side cabinet 1 drawer	TC-180CLOCK	TC-180KEYLOCK
TSC15R1D	15" PRO35™ Side Cabinet	TC-90CLOCK	TC-90KEYLOCK
TSC15R7	15" PRO35™ side cabinet 7 drawers	TC-180CLOCK	TC-180KEYLOCK
TSM26B3	26" PRO35™ tool chest 3 drawers	TC-180CLOCK	TC-180KEYLOCK
TSM26R3	26" PRO35™ tool chest 3 drawers	TC-180CLOCK	TC-180KEYLOCK
TST26B4	26" PRO35™ tool chest 4 drawers	TC-90CLOCK	TC-90KEYLOCK
TST26B4P	26" PRO35™ tool chest 4 drawers	TC-90CLOCK	TC-90KEYLOCK
TST26R4	26" PRO35™ tool chest 4 drawers	TC-90CLOCK	TC-90KEYLOCK
TST26R5F	26" PRO35™ deep tool chest 5 drawers	TC-90CLOCK	TC-90KEYLOCK
TST37R5F	37" PRO35™ tool chest 5 drawers	TC-90CLOCK	TC-90KEYLOCK
TST53R10F	53" PRO35™ tool chest 10 drawers	TC-90CLOCK	TC-90KEYLOCK
TSW26B9	26" PRO35™ roller cabinet 9 drawers	TC-180CLOCK	TC-180KEYLOCK
TSW26R4L	26" PRO35™ low roller cabinet	TC-180CLOCK	TC-180KEYLOCK
TSW26R6	26" PRO35™ roller cabinet 6 drawers	TC-180CLOCK	TC-180KEYLOCK
TSW26R6L	26" PRO35™ low roller cabinet	TC-180CLOCK	TC-180KEYLOCK
TSW26R7	26" PRO35™ roller cabinet 7 drawers	TC-180CLOCK	TC-180KEYLOCK
TSW26R9	26" PRO35™ roller cabinet 9 drawers	TC-180CLOCK	TC-180KEYLOCK
TSW37B8	37" PRO35™ roller cabinet 8 drawers	TC-180CLOCK	TC-180KEYLOCK
TSW37R7	37" PRO35™ roller cabinet 7 drawers	TC-180CLOCK	TC-180KEYLOCK
TSW53R9	53" PRO35™ roller cabinet 9 drawers	TC-180CLOCK	TC-180KEYLOCK
TSW64R15	64" PRO35™ roller cabinet 15 drawers	TC-180CLOCK	TC-180KEYLOCK







**SPARE PART FOR LOCKS**

- Set of 3 key type locks for TengTools tool boxes
- One common key number
- Enables a stack system to be converted to have one common key on all locks

Item ID: **TC-LOCK3**



**SPARE PART FOR LOCKS**

- Set of 3 key type locks for TengTools tool boxes
- One common key number
- Enables a stack system to be converted to have one common key on all locks

Item ID: **TC-LOCK5**



**SIDE PANEL FOR CABINET**

	Width (mm)	Depth (mm)	Height (mm)
Dimensions	456	25	805

Item ID: **TCW-SP01**

**TOOLBOX SPARE PARTS**

Item ID:	Description
TCWPRK	Spare Part For Locks Lock and Key 6-series
TC-BKEY	Spare Part For Locks Three Piece Blank Key
TC-NKEY	Spare Part For Locks Spare Key With Number
TCW-SW	Wheel Set 4" x 1-1/4"
TC-540W	Wheel Set for Tool Box
TCRFH	Side Handle for Cabinet
TCWIQ-SC	Wheel Set 6" x 2"
TCDSH	Side Handles for Top/Middle Box
TCNBC	Wheel Set 5" x 2"
ALUE804	Aluminium drawer handle 4 pieces black
ALUE803	Aluminium drawer handle 3 pieces black





\*Hooks not included

**SIDE PANEL WITH STAND**

	Width (mm)	Depth (mm)	Height (mm)
Dimensions	460	25	640

Item ID: **TCW-SP**



**TOOL HOOKS**

Item ID:	Description
TCW-HK10	Tool Hooks 7 x 90° & 3 x 45°
TCW-HK45	Tool Hooks 10 x 45°
TCW-HK90	Tool Hooks 10 x 90°
TCW-HK02	Tool Hooks 10 x Double Hooks
TCW-HK03	Tool Hooks 6 x 90°, 6 x 45° & 8 x Double Hooks



**SOCKET CLIP RAIL**

Item ID:	Description
ALU430	Single Track 430mm Aluminium Clip Rail
ALU450	450mm 4 Track Clip Rail Set with Clips and Handles 33 Pieces
ALU1000-1	Single Track 1 meter Aluminium Clip Rail
ALU1000-4	Four Track 1 meter Aluminium Clip Rail



**SOCKET CLIPS**

Item ID:	Description
ALU14	Socket Clips 1/4" Drive 10 Pieces
ALU38	Socket Clips 3/8" Drive 10 Pieces
ALU12	Socket Clips 1/2" Drive 10 Pieces
ALU34	Socket Clips 3/4" Drive 10 Pieces





**HOOK ON TRAY**

Item ID:	Width (mm)	Depth (mm)	Height (mm)
TCT01	230	101	139
TCT02	460	101	139
TCT03	640	101	139



**HOOK ON TRAY FOR CANS**

Item ID:	Width (mm)	Depth (mm)	Height (mm)	No. of Can Holders
TCC02	460	98	136	4
TCC03	640	98	136	6



\*T-bar not included

**HOOK ON TOOL HOLDER**

- Hook tool holder for tool panels
- Designed to hook in to the square holes on TengTools wall and side panels and wall cabinets
- Ideal for storing tools such as T bars etc

Item ID: **TCT04**



**ABS TOP FOR 26" CABINET**

- ABS tray designed to fit the top of TengTools standard width (26"/660mm) cabinets
- Individual parts areas plus positioning for a middle box or top box to give a very organised work area
- Protects the top of the roller cabinet from scratches and marks

Item ID: **ABS-TOP**





**37 MM THICK WORKTOP FOR CABINETS**

Item ID:	Description	Width (mm)	Depth (mm)	Thickness (mm)
TC-TB01	Work Top for 53" Cabinet	1354	460	37
TC-TB02	Work Top for 26" Cabinet	672	460	37



**STAINLESS STEEL WORK TOP**

Item ID:	Description	Width (mm)	Depth (mm)	Thickness (mm)
TC-TBS02	Stainless steel work top for 26" cabinet	665	454	20
TC-TBS04	Stainless steel work top for 37" cabinet	943	454	20



**18 MM LAMINATED WORK TOP**

Item ID:	Description	Width (mm)	Depth (mm)	Thickness (mm)
TC-TB08	18 mm laminated work top for side cabinet	372	454	18
TC-TB05	18 mm laminated work top for 26" roller cabinet	663	454	18
TC-TB03	18 mm laminated work top for 37" roller cabinet	948	455	18
TC-TB06	18 mm laminated work top for 53" roller cabinet	1340	454	18
TC-TB07	18 mm laminated work top for 64" roller cabinet	1623	454	18



**5 MM EVA TOP FOAM FOR ROLLER CABINET**

Item ID:	Description	Width (mm)	Depth (mm)	Thickness (mm)
EVA-453946	5 mm EVA top foam for 37" roller cabinet	946	453	5
EVA-453660	5 mm EVA top foam for 26" roller cabinet	453	660	5





**MECHANICS WORK CHAIR**

- Adjustable height to ensure a comfortable working position
- Padded seat with the TengTools logo
- Swivel castors to move around easily
- Handy storage shelf in the bottom of the stool keeping components close to hand

Item ID: **TCA06**



**MECHANICS CREEPER**

	Width (mm)	Length (mm)	Height (mm)
Dimensions	500	1050	155

Item ID: **TCA07**



**KNEELING PAD**

	Width (mm)	Length (mm)	Depth (mm)
Dimensions	210	450	30.5

Item ID: **KP01**



**KNEELING PAD**

	Width (mm)	Length (mm)	Depth (mm)
Dimensions	300	880	30.5

Item ID: **KP02**





**KNEELING PAD**

	Width (mm)	Length (mm)	Depth (mm)
Dimensions	320	480	30.5

Item ID: **KP03**



**WORK BENCH**

Item ID:	Description	Width (mm)	Depth (mm)	Thickness (mm)
TWB1500	Work Bench 1500mm	1500	800	927
TWB2000	Work Bench 2000mm	2000	800	927



**WORK BENCH TOOL PANEL KIT**

Item ID:	Description	Width (mm)	No. of Panels
TWB-1500A	Work Bench Tool Panel Kit 1500mm	1500	2
TWB-2000A	Work Bench Tool Panel Kit 2000mm	2000	4

**WORKBENCH SPARE PARTS**

Item ID:	Description
TWB-15TOP	Work Bench Work Top 1500mm
TWB-20TOP	Work Bench Work Top 2000mm
TWB-4WD	Work Bench Wheel Set
TWB-LEG	Work Bench Legs
TWB-20SQ	Work Bench Square Tube 1500mm
TWB-15SQ	Work Bench Square Tube 2000mm
TWB-PA	Work Bench Panel







\*Tool Cabinet not included

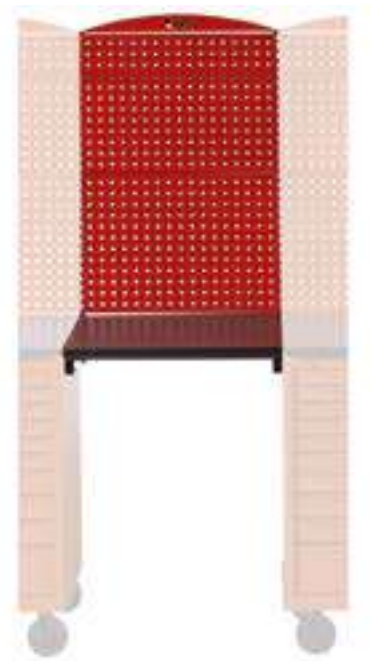

\*Tool Cabinet not included

**TOOL PANEL SETS**

Item ID:	Description
TC-S01	Tool Panel Set for 26" Cabinet
TC-SL01	Tool Panel Set for 53" Cabinet

**ADD ON PANEL SET BETWEEN CABINETS**

Item ID:	Description
TC-S02	Add On Panel Set for 26" Cabinet
TC-SL02	Add On Panel Set for 53" Cabinet

**ADD ON PANEL SPARE PARTS**

Item ID:	Description
TC-LBK	L Bracket
TWB-UPR	Work Bench Upright
TC-LEG	Support Leg
TC-FB01	Fixing Bar for 26" Cabinet
TC-FB02	Fixing Bar for 53" Cabinet
TC-FB03	Fixing Bar for 37" Cabinet
TC-H01	Header for 26" Cabinet
TC-H02	Header for 53" Cabinet
TC-H05	Header for 37" Cabinet

Item ID:	Description
TC-PA01	Tool Panel for 26" Cabinet
TC-PA02	Tool Panel for 53" Cabinet
TC-PA03	Tool Panel for 37" Cabinet
TC-UPRL	Upright Long Cabinet Left
TC-UPRR	Upright Long Cabinet Right
TC-160UR	Upright 1.6m
TC-UPRLS	Upright Short Left
TC-UPRRS	Upright Short Right





\*Tool Cabinet not included

**ADD ON PANEL SET BESIDE CABINET**

Item ID:	Description
TC-S03AL	Add On Panel Set Left for 26" Cabinet
TC-S03AR	Add On Panel Set Right for 26" Cabinet
TC-SL03AL	Add On Panel Set Left for 53" Cabinet
TC-SL03AR	Add On Panel Set Right for 53" Cabinet



\*Tool Cabinet not included

**ADD ON PANEL SET FOR 37" CABINET**

Item ID:	Description
TC-S03	Add On Panel Set 37" 2 Panels
TC-S04	Add On Panel Set 37" 1 Panel





\*Tool Cabinet not included

**MOBILE TOOL PANEL**

Item ID:	Description
TPM01	Mobile Tool Panel 2 Panels
TPM02	Mobile Tool Panel 4 Panels



**TROLLEY FOR TOP BOX**

- Frame with a set of 4 wheels for TengTools regular top boxes
- Creates a mobile tool box
- Especially useful if the tool box is heavily laden with tools

Item ID: **TCTMC**



**TROLLEY FOR SIDE CABINET**

- Frame with a set of 4 wheels for TengTools side cabinets
- Creates a mobile tool box or storage unit
- Especially useful if the cabinet is heavily laden

Item ID: **TCSMC**





**TOOL CABINET**

	Width (mm)	Height (mm)	Depth (mm)
Dimensions	660	600	305

Item ID: **TCB80**



**WALL HANGING TOOL CABINET 1350 MM**

	Width (mm)	Height (mm)	Depth (mm)
Dimensions	1335	700	200

Item ID: **TCB135**



**WALL HANGING TOOL CABINET 1800 MM**

	Width (mm)	Height (mm)	Depth (mm)
Dimensions	1800	700	200

Item ID: **TCB180**



# SOCKET SETS

## ALWAYS READY FOR ACTION







Tengtools socket sets are designed with a focus on quality, durability, and accessibility. We use high-grade materials such as chrome vanadium steel for sockets, and offer a wide range of sizes in both metric and AF measurements.

The sockets are clearly marked and easy to identify, and the sets are compatible with different types of ratchets and extensions.

## MECCA PRO™

### SOCKET SETS

IN DURABLE, SHOCKPROOF CASES

-  Secure lock system with click mechanism so you know the top is closed properly
-  Hard-wearing hinge with metal pin for increased life
-  Retractable handle, especially designed for comfort and durability.
-  Clear layout makes it easier to see which tools are missing
-  Rubber feet to prevent the box from sliding and which protects against scratching
-  Fully recyclable packaging that helps the environment









**1/4" SOCKET SET 6 PT 13 PIECES**



**CONTENTS**

- » 1/4" Ratchet FRP 45 Teeth
- » 1/4" Extension Bar 50 mm
- » 1/4" Socket 6 pt Metric
- » 4, 5, 5.5, 6, 7, 8, 9, 10, 11, 12, 13

Item ID: **M1413N1**



**1/4" SOCKET SET 6 PT WITH BELT CLIP 15 PIECES**



**CONTENTS**

- » 1/4" PH Bits 25mm
- » PH1, PH2
- » 1/4" Socket 6 pt Metric
- » 5.5, 6, 7, 8, 10, 12, 13
- » 1/4" Extension Bar 50mm
- » 1/4" Flat Bits 25mm 0.8 x 5.5mm 3 pcs
- » 1/4" Hex Bits 25mm
- » 4, 5
- » 1/4" Bit Adaptor Hex Bit Coupler
- » 1/4" Mini Ratchet 72 Teeth

Item ID: **TJ1415**





**1/4" SOCKET SET 6 PT WITH BELT CLIP 19 PIECES**

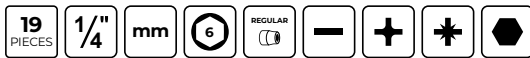

**CONTENTS**

- » 1/4" PH Bits 25mm
- » PH1, PH2
- » 1/4" Socket 6 pt Metric
- » 8, 9, 10, 11, 12, 13
- » 1/4" Hex Bits 25mm
- » 4, 5, 6
- » 1/4" Magnetic Bit Holder 50mm
- » 1/4" Flat Bits 25mm
- » 0.6 x 4.5, 0.8 x 5.5, 1.2 x 6.5
- » 1/4" PZ Bits 25mm
- » PZ1, PZ2
- » 1/4" Mini Bits Ratchet
- » Hex Socket Adaptor 1/4" Hex - 1/4" 25mm

Item ID: **TJ1419**



**1/4" SOCKET SET 6 PT WITH BELT CLIP 20 PIECES**

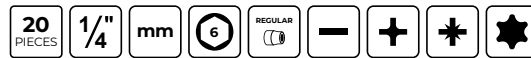

**CONTENTS**

- » 1/4" PH Bits 25mm
- » PH1, PH2
- » 1/4" Socket 6 pt Metric
- » 5.5, 6, 7, 8, 9, 10, 13
- » 1/4" Magnetic Bit Holder 50mm
- » 1/4" TX Bits 25mm
- » TX10, TX15, TX20
- » 1/4" Flat Bits 25mm
- » 0.6 x 4.5, 0.8 x 5.5, 1.2 x 6.5
- » 1/4" PZ Bits 25mm
- » PZ1, PZ2
- » 1/4" Mini Bits Ratchet
- » Hex Socket Adaptor 1/4" Hex - 1/4" 25mm

Item ID: **TJ1420**





**1/4" SOCKET SET 6 PT 8 PIECES**



**CONTENTS**

- » 1/4" Socket 6 pt Metric
- » 5.5, 6, 7, 8, 10, 12, 13
- » 1/4" Mini Ratchet 72 Teeth

Item ID: **T1408**



**1/4" SOCKET SET 6 PT 22 PIECES**



**CONTENTS**

- » 1/4" PH Bits 25mm
- » PH1, PH2
- » 1/4" Ratchet 72 Teeth
- » 1/4" Socket 6 pt Metric
- » 4, 5, 5.5, 6, 7, 8, 10, 12, 13
- » 1/4" Extension Bar 50mm
- » 1/4" TX Bits 25mm
- » TX10, TX15, TX20
- » 1/4" Flat Bits 25mm
- » 0.6 x 4.5, 0.8 x 5.5, 1.2 x 6.5
- » 1/4" PZ Bits 25mm
- » PZ1, PZ2
- » 1/4" Bit Adaptor Hex Bit Coupler

Item ID: **T1422**

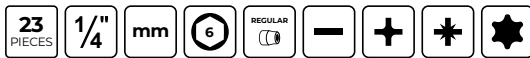

**1/4" SOCKET SET 6 PT 23 PIECES****CONTENTS**

- » Adjustable Wrench 100mm
- » 1/4" PH Bits 25mm
- » PH1, PH2
- » 1/4" Socket 6 pt Metric
- » 4, 5, 5.5, 6, 7, 8, 10, 12, 13
- » 1/4" Extension Bar 50mm
- » 1/4" TX Bits 25mm
- » TX10, TX15, TX20
- » 1/4" Flat Bits 25mm
- » 0.8 x 4.0, 0.8 x 5.5, 1.2 x 6.5
- » 1/4" PZ Bits 25mm
- » PZ1, PZ2
- » 1/4" Mini Bits Ratchet
- » Hex Socket Adaptor 1/4" Hex - 1/4" 25mm

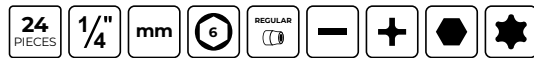
Item ID: **T1423****1/4" SOCKET SET 6 PT 24 PIECES****CONTENTS**

- » 1/4" PH Bits 25mm
- » PH1, PH2
- » 1/4" Socket 6 pt Metric
- » 4, 5, 5.5, 6, 7, 8, 10, 11, 12, 13
- » 1/4" Hex Bits 25mm
- » 3, 5, 6
- » 1/4" TX Bits 25mm
- » TX10, TX15, TX20
- » 1/4" Flat Bits 25mm
- » 0.8 x 4.0, 0.8 x 5.5
- » 1/4" Universal Joint
- » 1/4" Extension Bar 75mm
- » 1/4" Ratchet FRP 45 Teeth
- » 1/4" Bit Adaptor Hex Bit Coupler

Item ID: **T1424**



**1/4" SOCKET SET FLEXIBLE RATCHET 6 PT 20 PIECES**

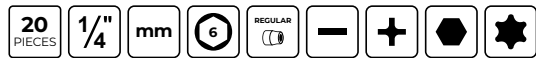

**CONTENTS**

- » 1/4" PH Bits 25mm
- » PH1, PH2
- » 1/4" Socket 6 pt Metric
- » 4, 5, 5.5, 6, 7, 8, 10, 11, 12, 13
- » 1/4" Hex Bits 25mm
- » 3, 5, 6
- » 1/4" TX Bits 25mm
- » TX10, TX15, TX20
- » 1/4" Flat Bits 25mm
- » 0.8 x 4.0, 0.8 x 5.5
- » 1/4" Universal Joint
- » 1/4" Ratchet Flexible Head 72 Teeth
- » 1/4" Extension Bar 75mm
- » 1/4" Bit Adaptor Hex Bit Coupler

Item ID: **T1424S**



**1/4" SOCKET SET 6 PT AF 35 PIECES**

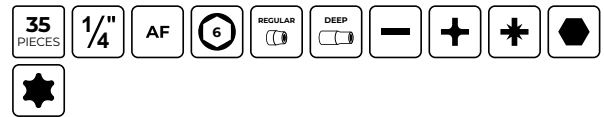

**CONTENTS**

- » 1/4" PH Bits 25mm
- » PH1, PH2
- » 1/4" Socket 6 pt AF
- » 3/16, 7/32, 9/32, 5/16, 11/32, 3/8, 7/16, 1/2
- » Reducing Adaptor 3/8"F - 1/4"M
- » 1/4" Extension Bar 50mm
- » 1/4" Extension Bar 100mm
- » 1/4" Hex Bits 25mm
- » 5, 6
- » 1/4" Deep Socket 6 pt AF
- » 3/16, 1/4, 5/16, 3/8, 7/16, 1/2
- » 1/4" TX Bits 25mm
- » TX10, TX15, TX20
- » 1/4" Flat Bits 25mm
- » 0.8 x 4.0, 0.8 x 5.5
- » 1/4" PZ Bits 25mm
- » PZ1, PZ2
- » Hex Key Metric
- » 1.5, 2, 2.5
- » 1/4" Universal Joint
- » 1/4" Ratchet FRP 45 Teeth
- » 1/4" Bit Adaptor Hex Bit Coupler

Item ID: **T1435AF**

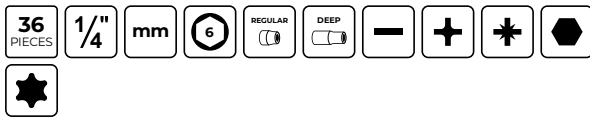

**1/4" SOCKET SET 6 PT 36 PIECES****CONTENTS**

- » 1/4" PH Bits 25mm
- » PH1, PH2
- » 1/4" Socket 6 pt Metric
- » 4, 5, 5.5, 6, 7, 8, 10, 11, 12, 13
- » Reducing Adaptor 3/8"F - 1/4"M
- » 1/4" Extension Bar 50mm
- » 1/4" Extension Bar 100mm
- » 1/4" Hex Bits 25mm
- » 5, 6
- » 1/4" Deep Socket 6 pt Metric
- » 6, 7, 8, 10, 12, 13
- » 1/4" TX Bits 25mm
- » TX10, TX15, TX20
- » 1/4" Flat Bits 25mm
- » 0.8 x 4.0, 0.8 x 5.5
- » 1/4" PZ Bits 25mm
- » PZ1, PZ2
- » 1/4" Universal Joint
- » 1/4" Ratchet FRP 45 Teeth
- » 1/4" Bit Adaptor Hex Bit Coupler

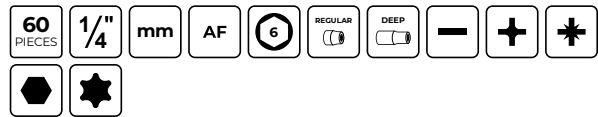
Item ID: **T1436****MECCA PRO 1/4" SOCKET SET 6 PT 60 PIECES****CONTENTS**

- » 1/4" PH Bits 25mm
- » PH1, PH2
- » 1/4" Socket 6 pt Metric
- » 4, 4.5, 5, 5.5, 6, 7, 8, 9, 10, 11, 12, 13
- » 1/4" TX Bit Socket
- » 10, 15, 20, 25, 27
- » 1/4" Socket 6 pt AF
- » 3/16, 7/32, 9/32, 5/16, 11/32, 3/8, 7/16, 1/2
- » 1/4" PH Bit Socket
- » PH1, PH2
- » 1/4" Extension Bar 50mm
- » 1/4" Extension Bar 100mm
- » 1/4" Hex Bits 25mm
- » 5, 6
- » 1/4" Deep Socket 6 pt AF
- » 1/4, 5/16, 3/8, 7/16, 1/2
- » 1/4" Deep Socket 6 pt Metric
- » 6, 7, 8, 10, 12, 13
- » 1/4" TX Bits 25mm
- » TX10, TX15, TX20
- » 1/4" Flat Bits 25mm
- » 0.8 x 4.0, 0.8 x 5.5
- » 1/4" Flat Bit Socket
- » 4, 5.5, 7
- » 1/4" PZ Bits 25mm
- » PZ1, PZ2
- » 1/4" Universal Joint
- » 1/4" Spinner Handle
- » 1/4" Ratchet FRP 45 Teeth
- » 1/4" Bit Adaptor Hex Bit Coupler
- » 1/4" Sliding T Bar

Item ID: **T1460**





**1/4" SOCKET CLIP RAIL SET 6 PT 12 PIECES**



**CONTENTS**

- » 1/4" Socket 6 pt Metric
- » 4, 4.5, 5, 5.5, 6, 7, 8, 9, 10, 11, 12, 13

Item ID: **M1412**



**1/4" DRIVE HEX BIT SOCKET CLIP RAIL METRIC 9-PIECE SET**

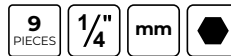

**CONTENTS**

- » 1/4" Hex Bit Socket Metric
- » 3, 4, 5, 5.5, 6, 7, 8, 10, 12

Item ID: **M1409HN**



**1/4" DEEP SOCKET CLIP RAIL SET 6 PT 9 PIECES**



**CONTENTS**

- » 1/4" Deep Socket 6 pt Metric
- » 4, 5, 6, 7, 8, 9, 10, 12, 13

Item ID: **M1407**



**1/4" TX BIT SOCKET CLIP RAIL SET 8 PIECES**

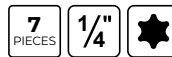

**CONTENTS**

- » 1/4" TX Bit Socket
- » 10, 15, 20, 25, 27, 30, 40

Item ID: **M1408TX**

**3/8" SOCKET SET 6 PT 12 PIECES****CONTENTS**

- » 3/8" Socket 6 pt Metric
- » 8, 10, 11, 12, 13, 14, 15, 16, 17, 19
- » 3/8" Extension Bar 75mm
- » 3/8" Ratchet FRP 45 Teeth

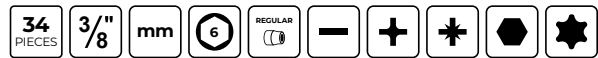
Item ID: **M3812N1****3/8" SOCKET SET 6 PT 34 PIECES****CONTENTS**

- » 1/4" TX Bits 25mm
- » TX10, TX15, TX20, TX25, TX27, TX30, TX40
- » 1/4" PH Bits 25mm
- » PH1, PH2, PH3
- » 1/4" Hex Bits 25mm
- » 3, 4, 5, 6
- » Reducing Adaptor 1/2" F - 3/8" M
- » 3/8" Socket 6 pt Metric
- » 8, 10, 11, 12, 13, 14, 15, 17, 19
- » 1/4" Flat Bits 25mm
- » 0.8 x 4.0, 0.8 x 5.5, 3
- » 1/4" PZ Bits 25mm
- » PZ1, PZ2, PZ3
- » 3/8" Bit Adaptor Hex bit coupler 1/4" Hex
- » 3/8" Extension Bar 150mm
- » 3/8" Extension Bar 75mm
- » 3/8" Ratchet FRP 45 Teeth

Item ID: **T3834**



**MECCA PRO 3/8" SOCKET SET 6 PT AF 35 PIECES**

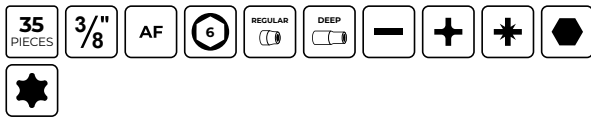

**CONTENTS**

- » 3/8" Deep Socket 6 pt AF
- » 3/8, 7/16, 1/2, 9/16, 11/16, 3/4
- » 1/4" PH Bits 25mm
- » PH1, PH2
- » 3/8" Socket 6 pt AF
- » 5/16, 3/8, 7/16, 1/2, 9/16, 5/8, 11/16, 3/4, 13/16, 7/8
- » 1/4" Hex Bits 25mm
- » 5, 6
- » Reducing Adaptor 1/2"F - 3/8"M
- » 3/8" Wobble Extension Bar 75mm
- » 1/4" TX Bits 25mm
- » TX10, TX15, TX20
- » 1/4" Flat Bits 25mm
- » 0.8 x 4.0, 0.8 x 5.5
- » 1/4" PZ Bits 25mm
- » PZ1, PZ2
- » 3/8" Bit Adaptor Hex bit coupler 1/4" Hex
- » 3/8" Spark Plug Socket
- » 16, 21
- » 3/8" Universal Joint
- » 3/8" Extension Bar 150mm
- » 3/8" Ratchet FRP 45 Teeth

Item ID: **T3835AF**



**MECCA PRO 3/8" SOCKET SET 6 PT 39 PIECES**

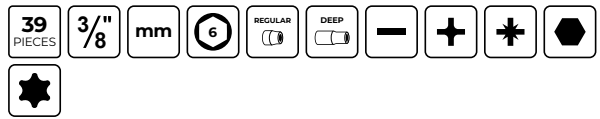

**CONTENTS**

- » 1/4" PH Bits 25mm
- » PH1, PH2
- » 1/4" Hex Bits 25mm
- » 5, 6
- » Reducing Adaptor 1/2"F - 3/8"M
- » 3/8" Socket 6 pt Metric
- » 8, 9, 10, 11, 12, 13, 14, 15, 16, 17, 18, 19, 21, 22
- » 3/8" Wobble Extension Bar 75mm
- » 1/4" TX Bits 25mm
- » TX10, TX15, TX20
- » 1/4" Flat Bits 25mm
- » 0.8 x 4.0, 0.8 x 5.5
- » 3/8" Deep Socket 6 pt Metric
- » 8, 10, 12, 13, 17, 19
- » 1/4" PZ Bits 25mm
- » PZ1, PZ2
- » 3/8" Bit Adaptor Hex bit coupler 1/4" Hex
- » 3/8" Spark Plug Socket
- » 16, 21
- » 3/8" Universal Joint
- » 3/8" Extension Bar 150mm
- » 3/8" Ratchet FRP 45 Teeth

Item ID: **T3839**





**MECCA PRO 3/8" SOCKET & TOOL SET 39 PIECES**

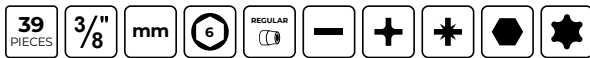

**CONTENTS**

- » 1/4" PH Bits 25mm
- » PH1, PH2
- » Combination Spanner Metric
- » 8, 10, 11, 12, 13, 14, 15, 17, 19
- » 1/4" Hex Bits 25mm
- » 5, 6
- » Reducing Adaptor 1/2" F - 3/8" M
- » 3/8" Socket 6 pt Metric
- » 8, 9, 10, 11, 12, 13, 14, 15, 16, 17, 18, 19, 21, 22
- » 1/4" TX Bits 25mm
- » TX10, TX15, TX20
- » 1/4" Flat Bits 25mm
- » 0.8 x 4.0, 0.8 x 5.5
- » 1/4" PZ Bits 25mm
- » PZ1, PZ2
- » 3/8" Bit Adaptor Hex bit coupler 1/4" Hex
- » 3/8" Universal Joint
- » 3/8" Extension Bar 150mm
- » 3/8" Ratchet FRP 45 Teeth

Item ID: **T3840**



**MECCA PRO 3/8" SOCKET & TOOL SET MM/AF 48 PIECES**

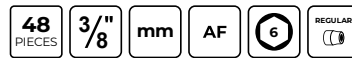

**CONTENTS**

- » Combination Spanner Metric
- » 8, 10, 12, 13, 14, 15, 16, 17, 18, 19
- » PH Screwdriver
- » PH0, PH1, PH2
- » Reducing Adaptor 1/2" F - 3/8" M
- » Flat Screwdriver
- » 0.5 x 3.0, 1.0 x 5.5, 1.2 x 6.5
- » 3/8" Socket 6 pt Metric
- » 8, 10, 12, 13, 14, 15, 16, 17, 18, 19
- » Combination Spanner AF
- » 7/16, 1/2, 9/16, 11/16
- » 3/8" Socket 6 pt AF
- » 7/16, 1/2, 9/16, 11/16
- » Side Cutting Plier TPR Grip 160mm
- » Water Pump Plier TPR Grip 250mm
- » Heavy Duty Combination Plier TPR Grip 190mm
- » 3/8" Bit Adaptor Hex bit coupler 1/4" Hex
- » 3/8" Spark Plug Socket
- » 16, 21
- » Long Nose Plier TPR Grip 205mm
- » 3/8" Universal Joint
- » 3/8" Extension Bar 150mm
- » 3/8" Extension Bar 75mm
- » Adjustable Wrench 200mm
- » Curved Jaw Power Grip Plier 190mm
- » 3/8" Ratchet FRP 45 Teeth

Item ID: **T3848**





**MECCA PRO 3/8" SOCKET & TOOL SET 67 PIECES**

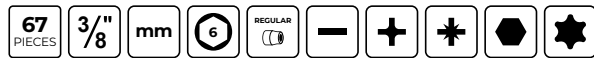

**CONTENTS**

- » 1/4" TX Bits 25mm  
TX8, TX10, TX15, TX20, TX25, TX27, TX30, TX40, TX45, TX50
- » 1/4" PH Bits 25mm  
PH0, PH1, PH2, PH3
- » Combination Spanner Metric  
8, 10, 11, 12, 13, 14, 15, 16, 17, 19
- » PH Screwdriver  
PH0, PH1, PH2
- » 1/4" Hex Bits 25mm  
3, 4, 5, 6, 8, 10
- » 3/8" Socket 6 pt Metric  
8, 9, 10, 11, 12, 13, 14, 15, 16, 17, 18, 19, 20, 22
- » Reducing Adaptor 1/2" F - 3/8" M
- » Flat Screwdriver  
0.5 x 3.0, 1.0 x 5.5, 1.2 x 6.5
- » 1/4" Flat Bits 25mm  
0.8 x 4.0, 0.8 x 5.5, 7
- » 1/4" PZ Bits 25mm  
PZ1, PZ2, PZ3
- » Water Pump Plier 240mm
- » 3/8" Bit Adaptor Hex bit coupler 1/4" Hex
- » 3/8" Universal Joint
- » 3/8" Extension Bar 150mm
- » 3/8" Extension Bar 75mm
- » Heavy Duty Combination Plier 185mm
- » Long Nose Plier 200mm
- » Side Cutting Plier 160mm
- » 3/8" Ratchet FRP 45 Teeth

Item ID: **T3867**



**MECCA PRO 3/8" SOCKET & TOOL SET 80 PIECES**

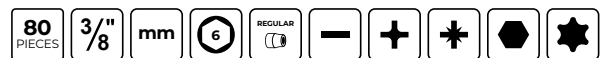

**CONTENTS**

- » 1/4" PH Bits 25mm: PH1, PH2, PH3
- » 3/8" Extension Bar 125mm
- » LED Torch With Pocket Clip
- » Flat Screwdriver: 0.5 x 3.0, 1.0 x 5.5
- » 1/4" Magnetic Bits Driver 217mm
- » 1/4" TPX Bits 25mm: TPX20, TPX25, TPX30
- » PH Screwdriver; PH1, PH2
- » Adjustable Wrench Wide Jaw 200mm
- » 1/4" Hex Bits 25mm  
4, 5, 6
- » 3/8" Socket 6 pt Metric  
8, 10, 11, 12, 13, 14, 15, 17, 19, 20, 21, 22
- » Reducing Adaptor 1/2" F - 3/8" M
- » Folding Hex Key Set 1.5-6 mm ALU 7 Pieces
- » 1/4" TX Bits 25mm  
TX10, TX15, TX20, TX25, TX30, TX40
- » Long Nose Plier 165mm
- » 1/4" PH G Bits 25mm PH2G 10 pcs
- » Measuring Tape Metric 5m
- » 1/4" ROB Bits 25mm  
1, 2, 3
- » 1/4" Flat Bits 25mm  
0.6 x 4.5, 0.8 x 5.5, 1.2 x 6.5
- » Combination Spanner Metric  
6, 7, 8, 10, 11
- » Combination Plier 180mm
- » 1/4" PZ Bits 25mm  
PZ1, PZ2, PZ3
- » Water Pump Plier 180mm
- » 3/8" Bit Adaptor Hex bit coupler 1/4" Hex
- » Double Ring Spanner Rigger Jigger 10 x 13mm
- » 3/8" Universal Joint
- » Utility Knife
- » Telescopic Pick Up Tool 760mm
- » Side Cutting Plier 160mm
- » Carpenters Claw Hammer 16oz
- » Folding Utility Saw
- » 3/8" Ratchet FRP 45 Teeth
- » Hex Socket Adaptor 1/4" Hex - 1/4" 25mm

Item ID: **TM080**



**3/8" SOCKET CLIP RAIL SET 6 PT 16 PIECES****CONTENTS**

- » 3/8" Socket 6 pt Metric
- » 7, 8, 9, 10, 11, 12, 13, 14, 15, 16, 17, 18, 19, 20, 21, 22

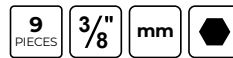
Item ID: **M3816****3/8" HEX BIT SOCKET CLIP RAIL SET 9 PIECES****CONTENTS**

- » 3/8" Hex Bit Socket Metric
- » 3, 4, 5, 5.5, 6, 7, 8, 10, 12

Item ID: **M3812****3/8" DEEP SOCKET CLIP RAIL SET 6 PT 7 PIECES****CONTENTS**

- » 3/8" Deep Socket 6 pt Metric
- » 10, 12, 13, 14, 15, 17, 19

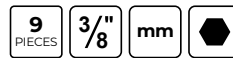
Item ID: **M3807****3/8" LONG HEX BIT SOCKET CLIP RAIL SET 9 PIECES****CONTENTS**

- » 3/8" Long Hex Bit Socket Metric
- » 3, 4, 5, 5.5, 6, 7, 8, 10, 12

Item ID: **M3809**





**3/8" BALL POINT LONG HEX BIT SOCKET CLIP RAIL SET**

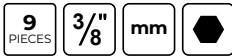

**CONTENTS**

- » 3/8" Hex Bit Socket Ball Point Metric
- » 3, 4, 5, 5.5, 6, 7, 8, 10, 12

Item ID: **M3809HBN**



**3/8" TPX BIT SOCKET CLIP RAIL SET 9 PIECES**

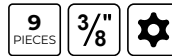

**CONTENTS**

- » 3/8" TPX Bit Socket
- » TPX10, TPX15, TPX20, TPX25, TPX27, TPX30, TPX40, TPX45, TPX50

Item ID: **M3813TPX**



**3/8" HEX BIT SOCKET CLIP RAIL SET AF 8 PIECES**

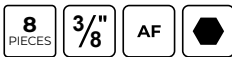

**CONTENTS**

- » 3/8" Hex Bit Socket AF
- » 3/32, 5/32, 3/16, 7/32, 1/4, 5/16, 3/8

Item ID: **M3811**



**3/8" TX BIT SOCKET CLIP RAIL SET 9 PIECES**

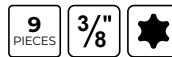

**CONTENTS**

- » 3/8" TX Bit Socket
- » TX10, TX15, TX20, TX25, TX27, TX30, TX40, TX45, TX50

Item ID: **M3813TX**



**3/8" LONG TX BIT SOCKET CLIP RAIL SET 9 PIECES****CONTENTS**

- » 3/8" Long TX Bit Socket
- » TX10, TX15, TX20, TX25, TX27, TX30, TX40, TX45, TX50

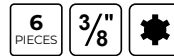
Item ID: **M3809TX****3/8" LONG RIBE® BIT SOCKET CLIP RAIL SET 6 PIECES****CONTENTS**

- » 3/8" Long Ribe® Bit Socket
- » 4, 5, 6, 8, 9, 10

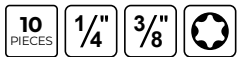
Item ID: **M3806****1/4" & 3/8" TX-E SOCKET CLIP RAIL SET 10 PIECES****CONTENTS**

- » 1/4" TX-E Socket
- » E4, E5, E6, E7, E8
- » 3/8" TX-E Socket
- » E10, E12, E14, E16, E18

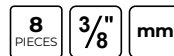
Item ID: **M3814****3/8" CROW FOOT WRENCH CLIP RAIL SET 8 PIECES****CONTENTS**

- » 3/8" Crow Foot Wrench
- » 10, 11, 12, 13, 16, 17, 18, 19

Item ID: **M3808MM**



**1/2" SOCKET SET 12 PT 12 PIECES**



**CONTENTS**

- » 1/2" Socket 12 pt Metric
- » 8, 10, 12, 13, 14, 15, 17, 18, 19, 24
- » 1/2" Ratchet FRP 45 Teeth
- » 1/2" Extension Bar 125mm

Item ID: **M1212N1**



**MECCA PRO 1/2" SOCKET SET 12 PT AF 20 PIECES**



**CONTENTS**

- » 1/2" Socket 12 pt AF
- » 3/8, 7/16, 1/2, 9/16, 5/8, 11/16, 3/4, 13/16, 7/8, 15/16, 1, 1-1/16, 1-1/8, 1-3/16, 1-1/4
- » 1/2" Universal Joint
- » 1/2" Ratchet FRP 45 Teeth
- » Step Up Adaptor 3/8"F - 1/2"M
- » 1/2" Extension Bar 63.5mm
- » 1/2" Extension Bar 150mm

Item ID: **T1220AF**



**MECCA PRO 1/2" SOCKET SET 12 PT 21 PIECES**

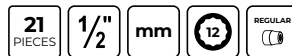

**CONTENTS**

- » 1/2" Socket 12 pt Metric
- » 10, 11, 12, 13, 14, 15, 16, 17, 18, 19, 21, 22, 24, 27, 30, 32
- » 1/2" Universal Joint
- » 1/2" Ratchet FRP 45 Teeth
- » Step Up Adaptor 3/8"F - 1/2"M
- » 1/2" Extension Bar 63.5mm
- » 1/2" Extension Bar 150mm

Item ID: **T1221**





**MECCA PRO 1/2" SOCKET SET 6 PT 21 PIECES**



**CONTENTS**

- » 1/2" Universal Joint
- » 1/2" Socket 6 pt Metric
  - » 10, 11, 12, 13, 14, 15, 16, 17, 18, 19, 21, 22, 24, 27, 30, 32
- » 1/2" Ratchet FRP 45 Teeth
- » Step Up Adaptor 3/8"F - 1/2"M
- » 1/2" Extension Bar 63.5mm
- » 1/2" Extension Bar 150mm

Item ID: **T1221-6**



**MECCA PRO 1/2" SOCKET SET 6 PT 34 PIECES**



**CONTENTS**

- » 1/2" Deep Socket 12 pt Metric
  - » 13, 14, 15, 16, 17, 18, 19, 24
- » 1/2" Spark Plug Socket
  - » 16, 21
- » 1/2" Universal Joint
- » 1/2" Extension Bar 255mm
- » 1/2" Extension Bar 125mm
- » 1/2" Socket 6 pt Metric
  - » 10, 11, 12, 13, 14, 15, 16, 17, 18, 19, 20, 21, 22, 23, 24, 27
- » 1/2" Ratchet FRP 45 Teeth
- » Step Up Adaptor 3/8"F - 1/2"M

Item ID: **T1234**





**MECCA PRO 1/2" SOCKET & TOOL SET MM/AF 44 PIECES**



**CONTENTS**

- » 1/2" Socket 12 pt Metric
- » 10, 11, 12, 13, 14, 15, 16, 17, 18, 19, 20, 21, 22, 23, 24, 27, 30, 32
- » 1/2" Deep Socket 12 pt Metric
- » 10, 13, 17, 19
- » PZ Screwdriver
- » PZ1, PZ2
- » 1/2" Spark Plug Socket
- » 16, 21
- » 1/2" Universal Joint
- » 1/2" Extension Bar 255mm
- » 1/2" Extension Bar 125mm
- » 1/2" Extension Bar 63.5mm
- » 1/2" Ratchet FRP 45 Teeth
- » 1/2" Socket 12 pt AF
- » 3/8, 1/2, 9/16, 19/32, 11/16, 25/32, 13/16, 1
- » Step Up Adaptor 3/8"F - 1/2"M
- » Double Ring Spanner Rigger Jigger 10 x 13mm
- » 1/2" Breaker Bar 450 mm DIN3122
- » Flat Screwdriver
- » 1.0 x 5.5, 1.2 x 6.5

Item ID: **T1244**



**MECCA PRO 1/2" SOCKET & TOOL SET 68 PIECES**

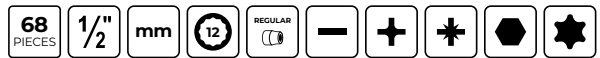

**CONTENTS**

- » 1/4" TX Bits 25mm
- » TX8, TX10, TX15, TX20, TX25, TX27, TX30, TX40, TX45, TX50
- » 1/4" PH Bits 25mm
- » PH0, PH1, PH2, PH3
- » 1/2" Socket 12 pt Metric
- » 10, 11, 12, 13, 14, 15, 16, 17, 18, 19, 21, 22, 24, 27, 30, 32
- » Combination Spanner Metric
- » 8, 10, 11, 12, 13, 14, 15, 16, 17, 19
- » PH Screwdriver
- » PH0, PH1, PH2
- » 1/4" Hex Bits 25mm
- » 3, 4, 5, 6, 8, 10
- » 1/2" Universal Joint
- » Flat Screwdriver
- » 0.5 x 3.0, 1.0 x 5.5, 1.2 x 6.5
- » 1/4" Flat Bits 25mm
- » 0.8 x 4.0, 0.8 x 5.5, 7
- » 1/2" Ratchet FRP 45 Teeth
- » 1/4" PZ Bits 25mm
- » PZ1, PZ2, PZ3
- » Water Pump Plier 240mm
- » Step Up Adaptor 3/8"F - 1/2"M
- » 1/2" Extension Bar 63.5mm
- » 1/2" Extension Bar 150mm
- » Heavy Duty Combination Plier 185mm
- » Long Nose Plier 200mm
- » Side Cutting Plier 160mm

Item ID: **T1268**



**1/2" SOCKET CLIP RAIL SET 12 PT 15 PIECES****CONTENTS**

- » 1/2" Socket 12 pt Metric
- » 10, 12, 13, 14, 15, 16, 17, 18, 19, 21, 22, 24, 27, 30, 32

Item ID: **M1215MM****1/2" SOCKET CLIP RAIL SET 12 PT AF 15 PIECES****CONTENTS**

- » 1/2" Socket 12 pt AF
- » 3/8, 7/16, 1/2, 9/16, 5/8, 11/16, 3/4, 13/16, 7/8, 15/16, 1, 1-1/16, 1-1/8, 1-3/16, 1-1/4

Item ID: **M1215AF****1/2" DEEP SOCKET CLIP RAIL SET 12 PT 8 PIECES****CONTENTS**

- » 1/2" Deep Socket 12 pt Metric
- » 13, 14, 15, 17, 19, 21, 22, 24

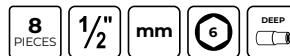
Item ID: **M1207****1/2" DEEP SOCKET CLIP RAIL SET 6 PT 8 PIECES****CONTENTS**

- » 1/2" Deep Socket 6 pt Metric
- » 13, 14, 15, 16, 17, 18, 19, 24

Item ID: **M1208-6**





**1/2" HEX BIT SOCKET CLIP RAIL SET 9 PIECES**

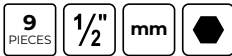

**CONTENTS**

- » 1/2" Hex Bit Socket Metric
- » 5, 6, 7, 8, 9, 10, 12, 14, 17

Item ID: **M1212**



**1/2" LONG HEX BIT SOCKET CLIP RAIL SET 6 PIECES**

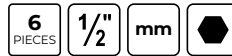

**CONTENTS**

- » 1/2" Long Hex Bit Socket Metric
- » 5, 6, 7, 8, 10, 12

Item ID: **M1211**



**1/2" HEX BIT SOCKET CLIP RAIL SET AF 9 PIECES**

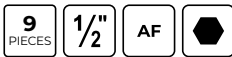

**CONTENTS**

- » 1/2" Hex Bit Socket AF
- » 1/2, 1/4, 3/16, 3/8, 5/16, 5/8, 7/32, 9/16, 9/32

Item ID: **M1209AF**



**1/2" TX-E SOCKET CLIP RAIL SET 9 PIECES**

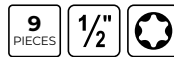

**CONTENTS**

- » 1/2" TX-E Socket
- » E10, E11, E12, E14, E16, E18, E20, E22, E24

Item ID: **M1210**



**1/2" TPX BIT SOCKET CLIP RAIL SET 9 PIECES****CONTENTS**

- » 1/2" TPX Bit Socket
- » TPX20, TPX25, TPX27, TPX30, TPX40, TPX45, TPX50, TPX55, TPX60

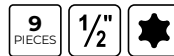
Item ID: **M1213TPX****1/2" LONG TX BIT SOCKET CLIP RAIL SET 9 PIECES****CONTENTS**

- » 1/2" Long TX Bit Socket
- » TX20, TX25, TX27, TX30, TX40, TX45, TX50, TX55, TX60

Item ID: **M1209TX****1/2" TX BIT SOCKET CLIP RAIL SET 9 PIECES****CONTENTS**

- » 1/2" TX Bit Socket
- » TX20, TX25, TX27, TX30, TX40, TX45, TX50, TX55, TX60

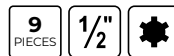
Item ID: **M1213TX****1/2" LONG RIBE® BIT SOCKET CLIP RAIL SET 9 PIECES****CONTENTS**

- » 1/2" Long Ribe® Bit Socket
- » 04, 05, 06, 08, 09, 10, 11, 12, 13

Item ID: **M1209**



**MECCA PRO 3/4" SOCKET SET 6 PT 18 PIECES**



**CONTENTS**

- » 3/4" Socket 6 pt Metric
- » 19, 21, 22, 24, 27, 30, 32, 33, 34, 36, 38, 41, 46, 50
- » 3/4" Extension Bar 400mm
- » 3/4" Extension Bar 200mm
- » 3/4" Sliding T Bar
- » 3/4" Ratchet Heavy Duty 72 Teeth

Item ID: **T3418-6**



**1" SOCKET SET 12 PT 15 PIECES**



**CONTENTS**

- » 1" Ratchet Head 24 Teeth
- » 1" Socket 12 pt Metric
- » 36, 41, 46, 50, 55, 60, 65, 70, 75, 80
- » 1" Extension Bar 400mm
- » 1" Extension Bar 200mm
- » 1" Power Bar 560mm
- » T Bar Adaptor 1"

Item ID: **M1115MM**

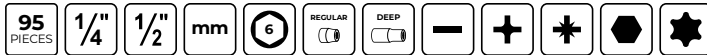

**MECCA PRO 1/4" & 1/2" SOCKET & TOOL SET 95 PIECES****CONTENTS**

- » 1/4" TX Bits 25mm
- » TX8, TX10, TX15, TX20, TX25, TX27, TX30, TX40
- » 1/4" PH Bits 25mm
- » PH0, PH1, PH2, PH3 (x2)
- » 1/4" Socket 6 pt Metric
- » 4, 4.5, 5, 5.5, 6, 7, 8, 9, 10, 11, 12, 13
- » Combination Spanner Metric
- » 8, 10, 12, 13, 14, 17
- » PH Screwdriver
- » PH1, PH2
- » PZ Screwdriver
- » PZ1, PZ2
- » 1/2" Spark Plug Socket 21mm
- » 1/4" Extension Bar 50mm
- » 1/4" Extension Bar 100mm
- » 1/4" Hex Bits 25mm
- » 3, 4, 5, 6, 8, 10
- » 1/2" Universal Joint
- » 1/4" Universal Joint
- » 1/2" Extension Bar 255mm
- » 1/2" Extension Bar 125mm
- » 1/4" Deep Socket 6 pt Metric
- » 4, 5, 6, 7, 8, 9, 10, 11, 12, 13
- » 1/2" Socket 6 pt Metric
- » 10, 11, 12, 13, 14, 15, 17, 19, 22, 24, 27, 30, 32
- » 1/4" Flat Bits 25mm
- » 0.8 x 4.0, 0.8 x 5.5, 7
- » 1/2" Bit Adaptor 5/16" Hex
- » 1/4" Magnetic Bit Holder 50mm
- » 1/2" Ratchet FRP 45 Teeth
- » 1/4" PZ Bits 25mm
- » PZ0, PZ1, PZ2, PZ3
- » Hex Key Metric
- » 1.5, 2, 2.5
- » Step Up Adaptor 3/8" F - 1/2" M
- » 1/4" Spinner Handle
- » 1/4" Ratchet FRP 45 Teeth
- » 1/4" Bit Adaptor Hex Bit Coupler
- » Flat Screwdriver
- » 0.5 x 3.0, 0.8 x 4.0
- » 1/4" Sliding T Bar
- » Hex Socket Adaptor 1/4" Hex - 1/4" 25mm

Item ID: **TM095**



**MECCA PRO 1/4", 3/8" & 1/2" SOCKET SET 106 PIECES**



**CONTENTS**

- » 1/4" TX Bits 25mm
- » TX8, TX10, TX15, TX20, TX25, TX27, TX30, TX40
- » 1/4" PH Bits 25mm
- » PH0, PH1, PH2, PH3
- » 1/4" Socket 6 pt Metric
- » 4, 5, 5.5, 6, 7, 8, 10, 11, 12, 13
- » 1/2" Socket 12 pt Metric
- » 19, 24, 27, 30, 32
- » Combination Spanner Metric
- » 8, 9, 10, 11, 12, 13, 14, 15, 16, 17, 18, 19
- » Reducing Adaptor 3/8"F - 1/4"M
- » Reducing Adaptor 1/2"F - 3/8"M
- » 1/4" TPX Bits 25mm
- » TPX10, TPX15, TPX20, TPX25, TPX27, TPX30, TPX40
- » 1/4" Extension Bar 50mm
- » 1/4" Extension Bar 75mm
- » 1/4" Hex Bits 25mm
- » 3, 4, 5, 6, 8, 10
- » 1/2" Extension Bar 255mm
- » 1/2" Extension Bar 63.5mm
- » 3/8" Socket 6 pt Metric
- » 8, 9, 10, 11, 12, 13, 14, 15, 16, 17, 18, 19, 21, 22
- » Double Flex Wrench Metric
- » 8 x 9, 10 x 11, 12 x 13, 14 x 15
- » 1/4" Flat Bits 25mm
- » 0.8 x 4.0, 0.8 x 5.5, 7
- » 1/4" Deep Socket 6 pt Metric
- » 6, 7, 8, 10, 12, 13
- » 1/4" PZ Bits 25mm
- » PZ1, PZ2, PZ3
- » 1/2" Flex Head Adaptor
- » Spanner Ring
- » 1/4" Universal Joint
- » 3/8" Universal Joint
- » 3/8" Bit Adaptor Hex bit coupler 1/4" Hex
- » 3/8" Spark Plug Socket
- » 16, 21
- » Step Up Adaptor 3/8"F - 1/2"M
- » 3/8" Extension Bar 150mm
- » 3/8" Extension Bar 75mm
- » 1/4" Ratchet FRP 45 Teeth
- » 1/4" Bit Adaptor Hex Bit Coupler
- » Bi-flex Wrench 1/4" Hex x 1/4"
- » Adjustable Wrench TPR Grip 250mm
- » 3/8" Ratchet FRP 45 Teeth

Item ID: **TM106**



**MECCA PRO 1/4", 3/8" & 1/2" SOCKET SET MM/AF 111 PIECES****CONTENTS**

- » 3/8" Deep Socket 6 pt AF
  - » 3/8, 7/16, 1/2, 9/16, 11/16, 3/4, 13/16, 7/8
- » 1/4" PH Bits 25mm
  - » PH1, PH2, PH3
- » 1/4" Socket 6 pt Metric
  - » 4, 5, 6, 7, 8, 10, 12
- » 3/8" Socket 6 pt AF
  - » 3/8, 7/16, 1/2, 9/16, 11/16, 3/4, 13/16, 7/8
- » 1/2" Socket 6 pt AF
  - » 11/16, 3/4, 13/16, 7/8, 1, 1-3/16
- » 1/4" Extension Bar Flexible 150mm
- » 1/4" Extension Bar 50mm
- » 1/4" Extension Bar 100mm
- » Step Up Adaptor 1/4"F - 3/8"M
- » Step Up Adaptor 3/8"F - 1/2"M
- » 1/4" Socket 6 pt AF
  - » 3/16, 7/32, 9/32, 1/4, 3/8, 7/16
- » 1/4" Hex Bits 25mm
  - » 3, 4, 5, 6, 7, 10
- » Reducing Adaptor 1/2"F - 3/8"M
- » 1/2" Extension Bar 255mm
- » 1/2" Extension Bar 63.5mm
- » 3/8" Deep Socket 6 pt Metric
  - » 8, 9, 10, 12, 13, 14, 15, 16, 17
- » 1/4" TX Bits 25mm
  - » TX10, TX15, TX20, TX25, TX30, TX40
- » 3/8" Socket 6 pt Metric
  - » 8, 9, 10, 12, 13, 14, 15, 16, 17
- » 1/2" Socket 6 pt Metric
  - » 17, 24, 27, 32
- » 1/4" Flat Bits 25mm
  - » 0.8 x 4.0, 0.8 x 5.5, 7
- » 1/2" Bit Adaptor 5/16" Hex
- » 1/2" Ratchet FRP 45 Teeth
- » 1/4" PZ Bits 25mm
  - » PZ1, PZ2, PZ3
- » 1/4" Universal Joint
- » 3/8" Universal Joint
- » 3/8" Bit Adaptor Hex bit coupler 1/4" Hex
- » 3/8" Spinner Handle
- » 1/4" Spinner Handle
- » 3/8" Spark Plug Socket
  - » 16, 21
- » 3/8" Extension Bar 150mm
- » 3/8" Extension Bar 75mm
- » 1/4" Ratchet FRP 45 Teeth
- » 1/4" Bit Adaptor Hex Bit Coupler
- » 1/4" Sliding T Bar
- » 3/8" Ratchet FRP 45 Teeth

Item ID: **TM111**





**MECCA PRO 1/4", 3/8" & 1/2" SOCKET & TOOL SET MM/AF 127 PIECES**



**CONTENTS**

- » 1/4" TX Bits 25mm
- » TX8, TX10, TX15, TX20, TX25, TX27, TX30, TX40
- » 1/4" PH Bits 25mm
- » PH0, PH1, PH2, PH3
- » 1/4" Socket 6 pt Metric
- » 4, 5, 5.5, 6, 7, 8, 10, 11, 12, 13
- » 1/2" Socket 12 pt Metric
- » 19, 24, 27, 30, 32
- » 1/4" Socket 6 pt AF
- » 3/16, 7/32, 1/4, 9/32, 5/16, 11/32, 3/8, 7/16, 1/2
- » Combination Spanner Metric
- » 8, 9, 10, 11, 12, 13, 14, 15, 16, 17, 18, 19
- » 3/8" Socket 6 pt AF
- » 5/16, 3/8, 7/16, 1/2, 9/16, 5/8, 11/16, 3/4, 13/16, 7/8
- » Reducing Adaptor 3/8"F - 1/4"M
- » Reducing Adaptor 1/2"F - 3/8"M
- » 1/4" Extension Bar 50mm
- » 1/4" Extension Bar 75mm
- » 1/4" Hex Bits 25mm
- » 3, 4, 5, 6, 8, 10
- » 1/2" Extension Bar 255mm
- » 1/2" Extension Bar 63.5mm
- » 3/8" Socket 6 pt Metric
- » 8, 9, 10, 11, 12, 13, 14, 15, 16, 17, 18, 19, 21, 22
- » 1/4" Flat Bits 25mm
- » 0.8 x 4.0, 0.8 x 5.5, 7
- » 1/4" Deep Socket 6 pt Metric
- » 6, 7, 8, 10, 12, 13
- » 1/4" PZ Bits 25mm
- » PZ1, PZ2, PZ3
- » 1/2" Flex Head Adaptor
- » Spanner Ring
- » 1/4" Universal Joint
- » 3/8" Universal Joint
- » 3/8" Bit Adaptor Hex bit coupler 1/4" Hex
- » 3/8" Spark Plug Socket
- » 16, 21
- » Step Up Adaptor 3/8"F - 1/2"M
- » 1/4" Ratcheting Bits Driver Set
- » 3/8" Extension Bar 150mm
- » 3/8" Extension Bar 75mm
- » 1/4" Ratchet FRP 45 Teeth
- » Adjustable Wrench Wide Jaw 250mm
- » 1/4" Bit Adaptor Hex Bit Coupler
- » 3/8" Ratchet FRP 45 Teeth
- » Hex Socket Adaptor 1/4" Hex - 1/4" 25mm

Item ID: **TM127**





### 1/2" XZN/TRIPLE SQUARE IMPACT SOCKET SET DIN 6 PIECES



#### CONTENTS

- » 1/2" XZN/Triple Square Impact Socket
- » 14 (x2), 16 (x2), 18 (x2)

Item ID: **T9206**



### MECCA PRO 1/2" DEEP IMPACT SOCKET SET DIN AF 18 PIECES



#### CONTENTS

- » 1/2" Deep Impact Socket DIN AF
- » 3/8, 7/16, 1/2, 9/16, 5/8, 11/16, 3/4, 13/16, 7/8, 15/16, 1, 1-1/16, 1-1/8, 1-1/4
- » Retaining Ring
- » 19 x 4, 24 x 4
- » Retaining Pin
- » 3 x 20, 3 x 25

Item ID: **T9218LAF**



### MECCA PRO 1/2" IMPACT SOCKET SET DIN AF 18 PIECES



#### CONTENTS

- » 1/2" Impact Socket DIN AF
- » 3/8, 7/16, 1/2, 9/16, 5/8, 11/16, 3/4, 13/16, 7/8, 15/16, 1, 1-1/16, 1-1/8, 1-1/4
- » Retaining Ring
- » 19 x 4, 24 x 4
- » Retaining Pin
- » 3 x 20, 3 x 25

Item ID: **T9218AF**



### MECCA PRO 1/2" IMPACT SOCKET SET DIN 22 PIECES



#### CONTENTS

- » 1/2" Impact Socket DIN Metric
- » 10, 11, 12, 13, 14, 15, 16, 17, 18, 19, 21, 22, 24, 27, 28, 29, 30, 32
- » Retaining Ring
- » 19 x 4, 24 x 4
- » Retaining Pin
- » 3 x 20, 3 x 25

Item ID: **T9222**





**MECCA PRO 1/2" DEEP IMPACT SOCKET SET DIN 22 PIECES**



**CONTENTS**

- » 1/2" Deep Impact Socket DIN Metric
- » 10, 11, 12, 13, 14, 15, 16, 17, 18, 19, 21, 22, 24, 27, 28, 29, 30, 32
- » Retaining Ring
- » 19 x 4.0, 24 x 4.0
- » Retaining Pin 3 x 20 mm
- » Retaining Pin 3 x 25 mm

Item ID: **T9222L**



**MECCA PRO 1/2" IMPACT SOCKET SET DIN 40 PIECES**



**CONTENTS**

- » 1/2" Impact Socket DIN Metric
- » 10, 11, 12, 13, 14, 15, 16, 17, 18, 19, 21, 22, 24, 27, 28, 29, 30, 32
- » 1/2" Deep Impact Socket DIN Metric
- » 10, 11, 12, 13, 14, 15, 16, 17, 18, 19, 21, 22, 24, 27, 28, 29, 30, 32
- » Retaining Ring
- » 19 x 4.0, 24 x 4.0
- » Retaining Pin 3 x 20 mm
- » Retaining Pin 3 x 25 mm

Item ID: **T9240**



DIN Standard sockets require a retaining ring and pin to safely secure the socket to the impact tool.

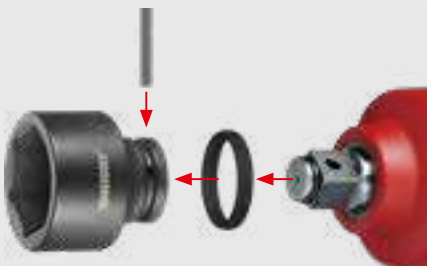

**MECCA PRO 3/4" IMPACT SOCKET SET DIN 17 PIECES**



**CONTENTS**

- » 3/4" Impact Socket DIN Metric
- » 19, 21, 22, 23, 24, 27, 30, 32, 33, 34, 36, 38, 41, 46, 50
- » Retaining Ring 36 x 5.0 mm
- » Retaining Pin 4 x 35 mm

Item ID: **T9417**





### MECCA PRO 3/4" DEEP IMPACT SOCKET SET DIN 17 PIECES



#### CONTENTS

- » 3/4" Deep Impact Socket DIN Metric
- » 19, 21, 22, 23, 24, 27, 30, 32, 33, 34, 36, 38, 41, 46, 50
- » Retaining Ring 36 x 5.0 mm
- » Retaining Pin 4 x 35 mm

Item ID: **T9417L**



### MECCA PRO 3/4" DEEP IMPACT SOCKET SET DIN AF 21 PIECES



#### CONTENTS

- » 3/4" Deep Impact Socket DIN AF
- » 3/4, 13/16, 7/8, 15/16, 1, 1-1/16, 1-1/8, 1-3/16, 1-1/4, 1-5/16, 1-3/8, 1-7/16, 1-1/2, 1-9/16, 1-5/8, 1-11/16, 1-3/4, 1-13/16, 1-7/8
- » Retaining Ring 36 x 5.0 mm
- » Retaining Pin 4 x 35 mm

Item ID: **T9421LAF**



### MECCA PRO 3/4" IMPACT SOCKET SET DIN AF 23 PIECES



#### CONTENTS

- » 3/4" Impact Socket DIN AF
- » 11/16, 3/4, 13/16, 7/8, 15/16, 1, 1-1/16, 1-1/8, 1-3/16, 1-1/4, 1-5/16, 1-3/8, 1-7/16, 1-1/2, 1-9/16, 1-5/8, 1-11/16, 1-3/4, 1-7/8, 1-15/16, 2
- » Retaining Ring 36 x 5.0 mm
- » Retaining Pin 4 x 35 mm

Item ID: **T9423AF**



### 3/8" IMPACT SOCKET CLIP RAIL SET ANSI 8 PIECES



#### CONTENTS

- » 3/8" Impact Socket ANSI Metric
- » 8, 10, 11, 13, 14, 16, 17, 19

Item ID: **9381**





**3/8" DEEP IMPACT SOCKET CLIP RAIL SET ANSI 8 PIECES**



**CONTENTS**

- » 3/8" Deep Impact Socket ANSI Metric
- » 8, 10, 11, 13, 14, 16, 17, 19

Item ID: **9386**



**1/2" DEEP IMPACT SOCKET CLIP RAIL SET ANSI 10 PIECES**



**CONTENTS**

- » 1/2" Deep Impact Socket ANSI Metric
- » 10, 11, 12, 13, 14, 17, 19, 21, 22, 24

Item ID: **9126**



**1/2" IMPACT SOCKET CLIP RAIL SET ANSI 10 PIECES**



**CONTENTS**

- » 1/2" Impact Socket ANSI Metric
- » 10, 11, 12, 13, 14, 17, 19, 21, 22, 24

Item ID: **9121**



**1/2" STUBBY IMPACT SOCKET CLIP RAIL SET DIN 12 PIECES**



**CONTENTS**

- » 1/2" Stubby Impact Socket DIN Metric
- » 10, 12, 13, 14, 15, 16, 17, 18, 19, 21, 22, 24

Item ID: **9207S12**





NEW



### 1" IMPACT SOCKET SET DIN 36 - 80MM 17 PIECES



#### CONTENTS

- » 1" Impact Socket DIN Metric  
36, 41, 46, 50, 55, 60, 65, 70, 75, 80
- » Impact Step Up Adaptor 3/4"F - 1"M DIN
- » Retaining Ring  
34 x 5.0, 45 x 7.0, 51 x 7.0
- » Retaining Pin  
4, 5

Item ID: **9117**

NEW



### 1" IMPACT SOCKET SET DIN 27 - 50MM 13 PIECES



#### CONTENTS

- » 1" Impact Socket DIN Metric  
27, 30, 32, 36, 38, 41, 46, 50
- » Impact Step Up Adaptor 3/4"F - 1"M DIN
- » Retaining Ring  
36 x 5.0, 45 x 7.0
- » Retaining Pin  
4, 5

Item ID: **9113**



# SOCKETS & ACCESSORIES

## GET THE JOB DONE, FAST

The socket range includes drives from ¼" to 1" and includes six-point sockets and twelve-point sockets, metric and imperial sizes as well as a wide range of bit sockets including Hex, TX, TX-E, and TPX.

### FRP RATCHETS

Quick release mechanism that makes it possible to release sockets and accessories with one hand

Ratchet mechanism with 45 teeth (8 degree intervals)

Lever for quick reversing between left and right-hand action

All individual parts and service kits are available and easy to fit

Fibre ratchet handle with steel reinforcement that is lighter than standard ratchet handles, but just as strong

Bi-material handle with an ergonomic design that makes the ratchet very comfortable to use, especially in cold environments







**1/4" RATCHET HEAD HEX**



ITEM ID:	ADAPTOR TYPE	NO. OF TEETH	T-DRIVE FACILITY
RHA14	Ratchet	72	No



**1/4" MINI PALM RATCHET**



ITEM ID:	NO. OF TEETH	QUICK RELEASE	REVERSE	LENGTH (mm)	HANDLE TYPE
1400M	45	Yes	Twist	76	Metal



**1/4" GEARLESS PALM RATCHET**



ITEM ID:	QUICK RELEASE	REVERSE
PM14	No	Twist



**1/4" MINI RATCHET 72 TEETH**



ITEM ID:	DRIVE	NO. OF TEETH	QUICK RELEASE	REVERSE	LENGTH (mm)	HANDLE TYPE
1400-72MN	1/4"	72	No	Twist	121	Bi-material

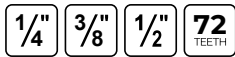

**RATCHET 72 TEETH**

ITEM ID:	DRIVE	NO. OF TEETH	QUICK RELEASE	REVERSE	LENGTH (mm)	HANDLE TYPE
1400-72N	1/4"	72	No	Twist	150	Bi-material
3800-72N	3/8"	72	Yes	Twist	203	Bi-material
1200-72N	1/2"	72	Yes	Twist	250	Bi-material

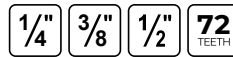
**RATCHET 72 TEETH FLEXIBLE HEAD**

ITEM ID:	DRIVE	NO. OF TEETH	QUICK RELEASE	REVERSE	LENGTH (mm)	HANDLE TYPE
1400-72SN	1/4"	72	No	Twist	121	Bi-material
3800-72SN	3/8"	72	Yes	Twist	178	Bi-material
1200-72SN	1/2"	72	Yes	Twist	190	Bi-material

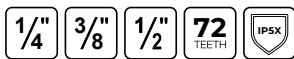
**RATCHET 72 TEETH IP5X**

ITEM ID:	DRIVE	NO. OF TEETH	QUICK RELEASE	REVERSE	LENGTH (mm)	HANDLE TYPE
1400-72U	1/4"	72	Yes	Flip reverse lever	142	Bi-material
3800-72MN	3/8"	72	Yes	Flip reverse lever	110	Metal
3800-72U	3/8"	72	Yes	Flip reverse lever	195	Bi-material
1200-72U	1/2"	72	Yes	Flip reverse lever	250	Bi-material

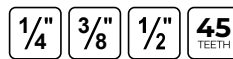
**RATCHET FRP 45 TEETH**

ITEM ID:	DRIVE	NO. OF TEETH	QUICK RELEASE	REVERSE	LENGTH (mm)	HANDLE TYPE
1400FRP	1/4"	45	Yes	Flip reverse lever	150	Bi-material
3800FRP	3/8"	45	Yes	Flip reverse lever	203	Bi-material
1200FRP	1/2"	45	Yes	Flip reverse lever	250	Bi-material





**1/4" LONG RATCHET FLEXIBLE HEAD**

1/4" 3/8" 1/2"

ITEM ID:	DRIVE	NO. OF TEETH	QUICK RELEASE	REVERSE	LENGTH (mm)	HANDLE TYPE
1400F	1/4"	43	Yes	Twist	200	Bi-material
3800F	3/8"	41	Yes	Twist	300	Bi-material
1200F	1/2"	45	No	Twist	400	Bi-material



**RATCHET HEAVY DUTY**

3/4" 1" 72 TEETH

ITEM ID:	DRIVE	NO. OF TEETH	QUICK RELEASE	REVERSE	LENGTH (mm)	HANDLE TYPE
M3400-72	3/4"	72	Yes	Twist	505	Rubber
M1100-72	1"	72	Yes	Twist	800	Metal



**1/4" RATCHET LONG ARM**

1/4" 3/8" 1/2"

ITEM ID:	DRIVE	NO. OF TEETH	QUICK RELEASE	REVERSE	LENGTH (mm)	HANDLE TYPE
1400L	1/4"	43	Yes	Twist	200	Bi-material
3800L	3/8"	41	Yes	Twist	300	Bi-material
1200L	1/2"	45	No	Twist	400	Bi-material



**3/8" EXTENDABLE RATCHET**

3/8" 1/2" 3/4"

ITEM ID:	DRIVE	NO. OF TEETH	QUICK RELEASE	REVERSE	LENGTH (mm)	HANDLE TYPE
3800-41E	3/8"	41	Yes	Push twist	250 - 356	Metal
1200-45E	1/2"	45	Yes	Push twist	356 - 508	Metal
M340072E	3/4"	72	Yes	Twist	545-860	Metal





### 1" RATCHET



ITEM ID:	DRIVE	NO. OF TEETH	QUICK RELEASE	REVERSE	LENGTH (mm)	HANDLE TYPE
M1100	1"	24	Yes	Flip reverse lever	665	Metal



### 1" POWER BAR



ITEM ID:	DRIVE	LENGTH (mm)	HANDLE TYPE
M110020	1"	560	Metal



### 1" RATCHET HEAD



ITEM ID:	DRIVE	NO. OF TEETH	QUICK RELEASE	REVERSE	LENGTH (mm)
M110010	1"	24	Yes	Flip reverse lever	165

### RATCHET REPAIR KITS

ITEM ID:	
1400-72NRK	Repair Kit 72 Teeth Ratchet 1400-72N
1400FRPRK	Repair Kit FRP Ratchet 1400FRP
1400FRK	Repair Kit for 1400F & 1400L
1400-72URK	Repair Kit 72 Teeth Ratchet 1400-72U
3800-72NRK	Repair Kit 72 Teeth Ratchet 3800-72N
3800FRPRK	Repair Kit FRP Ratchet 3800FRP
3800FRK	Repair Kit for 3800F & 3800L
3800-41ERK	Repair Kit 3800-41E
3800-72URK	Repair Kit 72 Teeth Ratchet 3800-72U & 3800-72MN
1200-72NRK	Repair Kit 72 Teeth Ratchet 1200-72N
1200FRPRK	Repair Kit FRP Ratchet 1200FRP
1200FRK	Repair Kit for 1200F, 1200L & 1200-45E
1200-72URK	Repair Kit 72 Teeth Ratchet 1200-72U
M3400-72RK	Repair Kit M3400-72 & M340072E
M1100-72RK	Repair Kit M110072
M1100RK	Repair Kit M1100







**FLEXIBLE SOCKET DRIVER**

1/4"

ITEM ID:	DRIVE	LENGTH (mm)	HANDLE TYPE	SAFETY LOCK	T-DRIVE FACILITY
MD514N	1/4"	275	Bi-material	No	Yes



**EXTRA LONG FLEXIBLE SOCKET DRIVER**

1/4"

ITEM ID:	DRIVE	LENGTH (mm)	HANDLE TYPE	SAFETY LOCK	T-DRIVE FACILITY
MD514L	1/4"	555	Bi-material	No	Yes



**SPINNER HANDLE**

1/4" 3/8"

ITEM ID:	DRIVE	LENGTH (mm)	HANDLE TYPE	SAFETY LOCK	T-DRIVE FACILITY
M140015-C	1/4"	150	Bi-material	No	No
M380015-C	3/8"	250	Bi-material	No	No



**ROTATING SPINNER HANDLE**

3/8"

ITEM ID:	DRIVE	LENGTH (mm)	HANDLE TYPE	SAFETY LOCK	T-DRIVE FACILITY
PT3810R	3/8"	250	Bi-material	No	No



**SPINNER HANDLES** with female intake in 1/4" & 3/8" drive are available. The handle can be used with a ratchet as an extension bar





**FLEX HANDLE**



ITEM ID:	DRIVE	LENGTH (mm)	HANDLE TYPE	SAFETY LOCK
M140012-C	1/4"	200		No
M380010A-C	3/8"	250		No
M380012-C	3/8"	300	Bi-material	No
M120010-C	1/2"	265	Bi-material	No
M120012-C	1/2"	410	Bi-material	No
M340070-C	3/4"	480		No
M340070S-C	3/4"	480		Yes
M110070	1"	650		No

**FLEX HANDLE & BREAKER BAR REPAIR KITS**

ITEM ID:	
M140012RK	Repair Kit for M140012-C
M380012RK	Repair Kit for M380012-C
1201ARK	Repair Kit 1201 & 1201A
M120010RK	Repair Kit M120010
M340070RK	Repair Kit M340070
M340070SRK	Repair Kit M340070S
M110070RK	Repair Kit M110070



**BREAKER BAR**

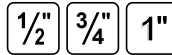

ITEM ID:	DRIVE	LENGTH (mm)	HANDLE TYPE	SAFETY LOCK
1201	1/2"	450	Bi-material	No
1201A	1/2"	600	Bi-material	No
3401	3/4"	990	Metal	No
1101	1"	990	Metal	No



**SPEED BRACE**

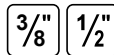

ITEM ID:	DRIVE	LENGTH (mm)	SAFETY LOCK
M380011-C	3/8"	380	No
M120011-C	1/2"	420	No





**1/4" EXTENSION BAR**

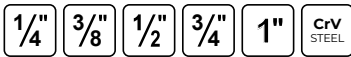

ITEM ID:	DRIVE	LENGTH (mm)	LENGTH (AF)	SAFETY LOCK	WOBBLE
M140020-C	1/4"	50	2	No	No
M140023-C	1/4"	75	3	No	No
M140021-C	1/4"	100	4	No	No
M140022-C	1/4"	150	6	No	No
M140038-C	1/4"	150	6	No	No
M140024-C	1/4"	305	12	No	No
M380020-C	3/8"	75	3	No	No
M380023-C	3/8"	125	5	No	No
M380021-C	3/8"	150	6	No	No
M380022-C	3/8"	254	10	No	No
M380024-C	3/8"	500	20	No	No
M120020-C	1/2"	63.5	2.5	No	No
M120021-C	1/2"	125	5	No	No
M120023-C	1/2"	150	6	No	No
M120022-C	1/2"	255	10	No	No
M120024-C	1/2"	500	20	No	No
M340020-C	3/4"	100	4	No	No
M340020S-C	3/4"	100	4	Yes	No
M340021-C	3/4"	200	8	No	No
M340021S-C	3/4"	200	8	Yes	No
M340022-C	3/4"	400	16	No	No
M340022S-C	3/4"	400	16	Yes	No
M110040	1"	200	8	No	No
M110050	1"	400	16	No	No



**3/8" WOBBLE EXTENSION BAR**

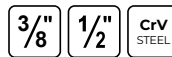

ITEM ID:	DRIVE	LENGTH (mm)	LENGTH 2 (AF)	SAFETY LOCK	WOBBLE
M380020W-C	3/8"	75	3	No	Yes
M380021W-C	3/8"	150	6	No	Yes
M380022W-C	3/8"	255	10	No	Yes
M120020W-C	1/2"	75	3	No	Yes
M120021W-C	1/2"	150	6	No	Yes
M120022W-C	1/2"	255	10	No	Yes



**UNIVERSAL JOINT**

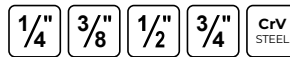

ITEM ID:	DRIVE	ADAPTOR TYPE	LENGTH (mm)
M140030-C	1/4"	Universal joint	33
M380030-C	3/8"	Universal joint	50
M120030-C	1/2"	Universal joint	69
M340030-C	3/4"	Universal joint	108





**1/4" SOCKET WITH MAGNETIC TIP**



ITEM ID:	DRIVE
M140060M	1/4"



**ADAPTORS**

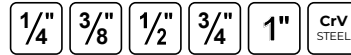

ITEM ID:	DRIVE	ADAPTOR TYPE	DRIVE 2	LENGTH (mm)	T-DRIVE FACILITY
M140036-C	1/4"	Step-up	3/8"	25	No
M140037	1/4" Hex	Hex coupler	1/4"	25	No
M140039	1/4" Hex	Hex coupler	1/4"	30	No
M380035-C	3/8"	Reducing	1/4"	25.4	Yes T-drive facility for 1/4" extension bar
M380036-C	3/8"	Step-up	1/2"	36	Yes T-drive facility for 1/2" extension bar
M380037	1/4" Hex	Hex coupler	3/8"	32	No
M120036-C	1/2"	Reducing	3/8"	39.5	Yes T-drive facility for 3/8" extension bar
M120037-C	1/2"	Step-up	3/4"	39.5	No
M340085-C	3/4"	Step-up	1"	62	No
M340086-C	3/4"	Reducing	1/2"	40	No
M110030	1"	T-Bar		82	Yes T-drive facility for 1" extension bar



**1/2" FLEX HEAD ADAPTOR**



ITEM ID:	DRIVE	ADAPTOR TYPE
M120080-C	1/2"	Flex head





**BIT ADAPTORS**



ITEM ID:	DRIVE	DRIVE 2	ADAPTOR TYPE	LENGTH (mm)
M140060-C	1/4"	1/4" Hex	Hex bit coupler	25
M380060-C	3/8"	1/4" Hex	Hex bit coupler	28
M380061-C	3/8"	10mm	Hex bit coupler	28
M120060-C	1/2"	5/16" Hex	Hex bit coupler	38
M120061-C	1/2"	10mm	Hex bit coupler	38
M120062-C	1/2"	12mm	Hex bit coupler	38
M120063-C	1/2"	1/4" Hex	Hex bit coupler	25



**INSERT STEP UP ADAPTOR**

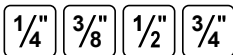

ITEM ID:	DRIVE	ADAPTOR TYPE	DRIVE 2	LENGTH (mm)
M140036M	1/4"	Step-up	3/8"	28
M380036M	3/8"	Step-up	1/2"	30
M120037M	1/2"	Step-up	3/4"	45
M340085M	3/4"	Step-up	1"	54



**STEP UP ADAPTOR SET 4 PIECES**

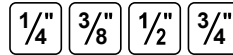

**CONTENTS**

- » Insert Step Up Adaptor 3/8" F - 1/2" M
- » Insert Step Up Adaptor 3/4 F - 1" M
- » Insert Step Up Adaptor 1/4" F - 3/8" M
- » Insert Step Up Adaptor 1/2" F - 3/4" M

Item ID: **MX04**



**SLIDING T BAR**



ITEM ID:	DRIVE	ADAPTOR TYPE	LENGTH (mm)	T-DRIVE FACILITY
M140050-C	1/4"	T-Bar	106	Yes
M380050-C	3/8"	T-Bar	170	Yes
M120050-C	1/2"	T-Bar	243	Yes
M340050-C	3/4"	T-Bar	450	Yes
M340050S-C	3/4"	T-Bar	450	Yes





**T-BAR HANDLE**

- T bar handle grip
- Plastic handle for use with T bars
- Use with TengTools extra long extension bars and 3/8"
- F x 1/4" M T bar adaptors
- Creates a much more comfortable grip

ITEM ID:

T-HD



**1/4" SOCKET 6 PT METRIC**



ITEM ID:	SIZE	LENGTH (mm)	DIAMETER (mm)	DIAMETER 2 (mm)
M140504-C	4	25	6.9	12
M1405045-C	4.5	25	7.5	12
M140505-C	5	25	8.1	12
M1405055-C	5.5	25	8.8	12
M140506-C	6	25	9.4	12
M140507-C	7	25	10.9	12
M140508-C	8	25	12	11.5
M140509-C	9	25	13.2	12
M140510-C	10	25	14.7	13
M140511-C	11	25	16	13
M140512-C	12	25	16.9	13.5
M140513-C	13	25	17.7	14



**1/4" SOCKET 12 PT METRIC**



ITEM ID:	SIZE	LENGTH (mm)	DIAMETER (mm)	DIAMETER 2 (mm)
M14050412-C	4	25	6.9	12
M14050512-C	5	25	8.1	12
M140505512-C	5.5	25	8.8	12
M14050612-C	6	25	9.4	12
M14050712-C	7	25	10.9	12
M14050812-C	8	25	12	11.5
M14050912-C	9	25	13.2	12
M14051012-C	10	25	14.7	13
M14051112-C	11	25	16	13
M14051212-C	12	25	16.9	13.5
M14051312-C	13	25	17.7	14







**1/4" SOCKET 6 PT AF**



ITEM ID:	SIZE	LENGTH (mm)	DIAMETER (mm)	DIAMETER 2 (mm)
M140106-C	3/16	25	8	12
M140107-C	7/32	25	8.8	12
M140108-C	1/4	25	10	12
M140109-C	9/32	25	12	10.9
M140110-C	5/16	25	12	11.4
M140111-C	11/32	25	13.2	11.9
M140112-C	3/8	25	14.4	12.4
M140114-C	7/16	25	16	12.9
M140116-C	1/2	25	17.7	13.9



**1/4" SOCKET 12 PT AF**



ITEM ID:	SIZE	LENGTH (mm)	DIAMETER (mm)	DIAMETER 2 (mm)
M14010612-C	3/16	25	8	12
M14010712-C	7/32	25	8.8	12
M14010812-C	1/4	25	10	12
M14010912-C	9/32	25	12	10.9
M14011012-C	5/16	25	12	11.4
M14011112-C	11/32	25	13.2	11.9
M14011212-C	3/8	25	14.4	12.4
M14011412-C	7/16	25	16	12.9
M14011612-C	1/2	25	17.7	13.9





**1/4" DEEP SOCKET 6 PT METRIC**



ITEM ID:	SIZE	LENGTH (mm)	DIAMETER (mm)	DIAMETER 2 (mm)
M140604-C	4	49.5	6.9	11.8
M140605-C	5	49.5	8	11.8
M1406055-C	5.5	49.5	8.8	11.8
M140606-C	6	49.5	9.4	11.8
M140607-C	7	49.5	10.9	11.8
M140608-C	8	49.5	11.8	11.8
M140609-C	9	49.5	12.8	12.8
M140610-C	10	49.5	14.5	14.5
M140611-C	11	49.5	15.6	15.6
M140612-C	12	49.5	16.6	16.6
M140613-C	13	49.5	17.6	17.6



**1/4" DEEP SOCKET 12 PT METRIC**



ITEM ID:	SIZE	LENGTH (mm)	DIAMETER (mm)	DIAMETER 2 (mm)
M14060612-C	6	49.5	9.4	11.8
M14060712-C	7	49.5	10.9	11.8
M14060812-C	8	49.5	11.8	11.8
M14060912-C	9	49.5	12.8	12.8
M14061012-C	10	49.5	14.5	14.5
M14061112-C	11	49.5	15.6	15.6
M14061212-C	12	49.5	16.6	16.6
M14061312-C	13	49.5	17.6	17.6



**"Hip Grip"**

All sockets are produced according to TengTools "hip grip" system, which means the socket grips on the flat surfaces of the nut rather than on the corner. This system helps to prevent damage to nuts and bolts and makes it possible to grip nuts and bolts which already have damaged corners.

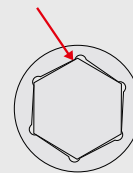



**1/4" DEEP SOCKET 6 PT AF**



ITEM ID:	SIZE	LENGTH (mm)	DIAMETER (mm)	DIAMETER 2 (mm)
M140206-C	3/16	49.5	8	11.8
M140207-C	7/32	49.5	9	11.8
M140208-C	1/4	49.5	10	11.8
M140209-C	9/32	49.5	11	11.8
M140210-C	5/16	49.5	11.8	11.8
M140211-C	11/32	49.5	12.8	12.8
M140212-C	3/8	49.5	14.5	14.5
M140214-C	7/16	49.5	15.6	15.6
M140216-C	1/2	49.5	17.6	17.6



**1/4" DEEP SOCKET 12 PT AF**



ITEM ID:	SIZE	LENGTH (mm)	DIAMETER (mm)	DIAMETER 2 (mm)
M14020612-C	3/16	49.5	8	11.8
M14020712-C	7/32	49.5	9	11.8
M14020812-C	1/4	49.5	10	11.8
M14020912-C	9/32	49.5	11	11.8
M14021012-C	5/16	49.5	11.8	11.8
M14021112-C	11/32	49.5	12.8	12.8
M14021212-C	3/8	49.5	14.5	14.5
M14021412-C	7/16	49.5	15.6	15.6
M14021612-C	1/2	49.5	17.6	17.6



**1/4" FLAT BIT SOCKET**



ITEM ID:	SIZE	TOTAL LENGTH (mm)	BIT LENGTH (mm)	DIAMETER (mm)
M141404-C	4	32	15	12
M1414055-C	5.5	32	15	12
M141407-C	7	32	15	12



**1/4" PH BIT SOCKET**



ITEM ID:	SIZE	TOTAL LENGTH (mm)	BIT LENGTH (mm)	DIAMETER (mm)
M141300-C	PH0	32	15	12
M141301-C	PH1	32	15	12
M141302-C	PH2	32	15	12
M141303-C	PH3	32	15	12





**1/4" PZ BIT SOCKET**



ITEM ID:	SIZE	TOTAL LENGTH (mm)	BIT LENGTH (mm)	DIAMETER (mm)
M141601-C	PZ1	32	15	12
M141602-C	PZ2	32	15	12
M141603-C	PZ3	32	15	12



**1/4" TX BIT SOCKET**



ITEM ID:	SIZE	TOTAL LENGTH (mm)	BIT LENGTH (mm)	DIAMETER (mm)
M141210T-C	10	32	15	12
M141215T-C	15	32	15	12
M141220T-C	20	32	15	12
M141225T-C	25	32	15	12
M141227T-C	27	32	15	12
M141230T-C	30	32	15	12
M141240T-C	40	32	15	12



**1/4" HEX BIT SOCKET METRIC**



ITEM ID:	SIZE	TOTAL LENGTH (mm)	BIT LENGTH (mm)	DIAMETER (mm)
M141503-C	3	32	15	12
M141504-C	4	32	15	12
M141505-C	5	32	15	12
M141505S-C	5.5	32	15	12
M141506-C	6	32	15	12
M141507-C	7	32	15	12
M141508-C	8	32	15	12
M141510-C	10	32	15	12
M141512-C	12	32	15	12



**1/4" TX-E SOCKET**



ITEM ID:	SIZE	LENGTH (mm)	DIAMETER (mm)	DIAMETER 2 (mm)
M140704-C	E4	25	5.8	12
M140705-C	E5	25	6.8	12
M140706-C	E6	25	8	12
M140707-C	E7	25	9.4	12
M140708-C	E8	25	10.4	12





**3/8" SOCKET 6 PT METRIC**



ITEM ID:	SIZE	LENGTH (mm)	DIAMETER (mm)	DIAMETER 2 (mm)
M380507-C	7	26	10.8	17.1
M380508-C	8	26	12	17.1
M380509-C	9	26	13.1	17.1
M380510-C	10	26	14.7	17.1
M380511-C	11	26	16	17.1
M380512-C	12	26	17.1	16.5
M380513-C	13	26	18.3	16.9
M380514-C	14	26	19.5	17.8
M380515-C	15	26	20.4	17.8
M380516-C	16	29	22.1	18.9
M380517-C	17	29	23.3	18.9
M380518-C	18	29	24.2	20
M380519-C	19	29	25.7	21
M380520-C	20	29	26.7	22
M380521-C	21	29	27.7	23
M380522-C	22	29	29.8	24



**3/8" SOCKET 12 PT METRIC**

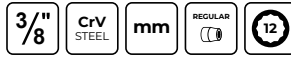

ITEM ID:	SIZE	LENGTH (mm)	DIAMETER (mm)	DIAMETER 2 (mm)
M38050812-C	8	26	12	17.1
M38050912-C	9	26	13.1	17.1
M38051012-C	10	26	14.7	17.1
M38051112-C	11	26	16	17.1
M38051212-C	12	26	17.1	16.5
M38051312-C	13	26	18.3	16.9
M38051412-C	14	26	19.5	17.8
M38051512-C	15	26	20.4	17.8
M38051612-C	16	29	22.1	18.9
M38051712-C	17	29	23.3	18.9
M38051812-C	18	29	24.2	20
M38051912-C	19	29	25.7	21
M38052212-C	22	29	29.8	24





**3/8" SOCKET 6 PT AF**



ITEM ID:	SIZE	LENGTH (mm)	DIAMETER (mm)	DIAMETER 2 (mm)
M380110-C	5/16	26	11.7	17.1
M380112-C	3/8	26	14.2	17.1
M380114-C	7/16	26	16.3	17.1
M380116-C	1/2	26	18.3	16.9
M380118-C	9/16	26	19.5	17.8
M380120-C	5/8	29	22.1	18.9
M380122-C	11/16	29	24.2	20
M380124-C	3/4	29	25.7	21
M380126-C	13/16	29	27.7	23
M380128-C	7/8	29	29.5	24



**3/8" SOCKET 12 PT AF**



ITEM ID:	SIZE	LENGTH (mm)	DIAMETER (mm)	DIAMETER 2 (mm)
M38011212-C	3/8	26	14.2	17.1
M38011412-C	7/16	26	16.3	17.1
M38011612-C	1/2	26	18.3	16.9
M38011812-C	9/16	26	19.5	17.8
M38012012-C	5/8	29	22.1	18.9
M38012212-C	11/16	29	24.2	20
M38012412-C	3/4	29	25.7	21



**6-point sockets v 12-point sockets**

12-point sockets, common in Aircraft Maintenance and Engineering, are ideal for use in confined space and for fast lightweight work. 6-point sockets are ideal for when extra torque needs to be applied. They are designed to contact the head of a fastener well away from the corners, this dramatically reduces the likelihood of slippage and rounding over of the corners.







**3/8" DEEP SOCKET 6 PT METRIC**



ITEM ID:	SIZE	LENGTH (mm)	DIAMETER (mm)	DIAMETER 2 (mm)
M380607-C	7	45.5	10.8	16.5
M380608-C	8	45.5	12	16.5
M380609-C	9	45.5	13.1	16.5
M380610-C	10	45.5	14.7	16.5
M380611-C	11	45.5	16.5	16.5
M380612-C	12	45.5	17.1	17.1
M380613-C	13	45.5	18.5	18.5
M380614-C	14	50	19.5	19.5
M380615-C	15	53	20.4	20.4
M380616-C	16	53	22	22
M380617-C	17	56	23.3	23.3
M380618-C	18	56	24.2	24.2
M380619-C	19	56	25.7	25.7
M380620-C	20	63.5	26.8	26.8
M380621-C	21	63.5	27.7	27.7
M380622-C	22	63.5	29.5	29.5



**3/8" DEEP SOCKET 12 PT METRIC**

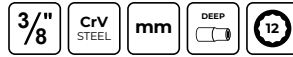

ITEM ID:	SIZE	LENGTH (mm)	DIAMETER (mm)	DIAMETER 2 (mm)
M38060712-C	7	45.5	10.8	16.5
M38060812-C	8	45.5	12.8	16.5
M38060912-C	9	45.5	13.1	16.5
M38061012-C	10	45.5	14.7	16.5
M38061112-C	11	45.5	16	16.5
M38061212-C	12	45.5	17.1	17.1
M38061312-C	13	45.5	18.5	18.5
M38061412-C	14	50	19.5	19.5
M38061512-C	15	53	20.4	20.4
M38061612-C	16	53	22	22
M38061712-C	17	56	13.3	13.3
M38061812-C	18	56	24.2	24.2
M38061912-C	19	56	25.7	25.7
M38062012-C	20	63.5	26.8	26.8
M38062112-C	21	63.5	27.7	27.7
M38062212-C	22	63.5	29.5	29.5





**3/8" DEEP SOCKET 6 PT AF**



ITEM ID:	SIZE	LENGTH (mm)	DIAMETER (mm)	DIAMETER 2 (mm)
M380212-C	3/8	45.5	14.2	16.5
M380214-C	7/16	45.5	16.5	16.5
M380216-C	1/2	45.5	18.5	18.5
M380218-C	9/16	50	19.5	19.5
M380220-C	5/8	53	22	22
M380222-C	11/16	56	24.2	24.2
M380224-C	3/4	56	25.7	25.7
M380226-C	13/16	63.5	27.7	27.7
M380228-C	7/8	63.5	29.5	29.5



**3/8" DEEP SOCKET 12 PT AF**



ITEM ID:	SIZE	LENGTH (mm)	DIAMETER (mm)	DIAMETER 2 (mm)
M38021212-C	3/8	45.5	14.2	16.5
M38021412-C	7/16	45.5	16.5	16.5
M38021612-C	1/2	45.5	18.5	18.5
M38021812-C	9/16	50	19.5	19.5
M38022012-C	5/8	53	22	22
M38022212-C	11/16	56	24.2	24.2
M38022412-C	3/4	56	25.7	25.7



Size clearly etched on the side of every socket



AF

mm

Made from extra strong chrome vanadium steel

Easily identify between metric & AF sockets as 2 rings are etched on the side of each metric socket and 1 ring on each AF socket





**3/8" T-BAR DEEP SOCKET 6 PT METRIC**



ITEM ID:	SIZE	LENGTH (mm)	DIAMETER (mm)
TBSKT07	7	300	10
TBSKT08	8	300	12
TBSKT10	10	300	15
TBSKT12	12	300	17
TBSKT13	13	300	19
TBSKT14	14	300	20
TBSKT17	17	300	23.5
TBSKT19	19	300	26
T-HD01		200	



**3/8" HEX BIT SOCKET METRIC**



ITEM ID:	SIZE	TOTAL LENGTH (mm)	BIT LENGTH (mm)	DIAMETER (mm)
M381503-C	3	49.5	23	17.9
M381504-C	4	49.5	23	17.9
M381505-C	5	49.5	23	17.9
M3815055-C	5.5	49.5	23	17.9
M381506-C	6	49.5	23	17.9
M381507-C	7	49.5	23	17.9
M381508-C	8	49.5	23	17.9
M381510-C	10	49.5	23	17.9
M381512-C	12	49.5	23	22



**3/8" DEEP T BAR SOCKET SET 10 PIECES**



**CONTENTS**

- » 3/8" T-Bar Deep Socket 6 pt Metric
- » 7, 8, 10, 12, 13, 14, 17, 19
- » T Bar for T Bar Sockets
- » T bar handle

Item ID: **TBW10**





**3/8" LONG HEX BIT SOCKET METRIC**



ITEM ID:	SIZE	TOTAL LENGTH (mm)	BIT LENGTH (mm)	DIAMETER (mm)
M382503-C	3	100	74	17.9
M382504-C	4	100	74	17.9
M382505-C	5	100	74	17.9
M3825055-C	5.5	100	74	17.9
M382506-C	6	100	74	17.9
M382507-C	7	100	74	17.9
M382508-C	8	100	74	17.9
M382510-C	10	100	74	17.9
M382512-C	12	100	74	17.9



**3/8" HEX BIT SOCKET BALL POINT METRIC**



ITEM ID:	SIZE	TOTAL LENGTH (mm)	BIT LENGTH (mm)	DIAMETER (mm)
M381503BL-C	3	100	74	17.8
M381504BL-C	4	100	74	17.8
M381505BL-C	5	100	74	17.8
M3815055BL-C	5.5	100	74	17.8
M381506BL-C	6	100	74	17.8
M381507BL-C	7	100	74	17.8
M381508BL-C	8	100	74	17.8
M381510BL-C	10	100	74	17.8
M381512BL-C	12	100	74	22





**3/8" HEX BIT SOCKET AF**



ITEM ID:	SIZE	TOTAL LENGTH (mm)	BIT LENGTH (mm)	DIAMETER (mm)
M381103-C	3/32	49.5	23	17.9
M381104-C	1/8	49.5	23	17.9
M381105-C	5/32	49.5	23	17.9
M381106-C	3/16	49.5	23	17.9
M381107-C	7/32	49.5	23	17.9
M381108-C	1/4	49.5	23	17.9
M381110-C	5/16	49.5	23	17.9
M381112-C	3/8	49.5	23	17.9



**3/8" TX BIT SOCKET**



ITEM ID:	SIZE	TOTAL LENGTH (mm)	BIT LENGTH (mm)	DIAMETER (mm)
M381210T-C	TX10	49.5	23	17.9
M381215T-C	TX15	49.5	23	17.9
M381220T-C	TX20	49.5	23	17.9
M381225T-C	TX25	49.5	23	17.9
M381227T-C	TX27	49.5	23	17.9
M381230T-C	TX30	49.5	23	17.9
M381240T-C	TX40	49.5	23	17.9
M381245T-C	TX45	49.5	23	17.9
M381250T-C	TX50	49.5	23	17.9



**3/8" LONG RIBE® BIT SOCKET**



ITEM ID:	SIZE	TOTAL LENGTH (mm)	BIT LENGTH (mm)	DIAMETER (mm)
M382704-C	04	100	74	17.9
M382705-C	05	100	74	17.9
M382706-C	06	100	74	17.9
M382708-C	08	100	74	17.9
M382709-C	09	100	74	17.9
M382710-C	10	100	74	17.9





**3/8" LONG TX BIT SOCKET**



ITEM ID:	SIZE	TOTAL LENGTH (mm)	BIT LENGTH (mm)	DIAMETER (mm)
M382210T-C	TX10	100	74	17.9
M382215T-C	TX15	100	74	17.9
M382220T-C	TX20	100	74	17.9
M382225T-C	TX25	100	74	17.9
M382227T-C	TX27	100	74	17.9
M382230T-C	TX30	100	74	17.9
M382240T-C	TX40	100	74	17.9
M382245T-C	TX45	100	74	17.9
M382250T-C	TX50	100	74	17.9



**3/8" TPX BIT SOCKET**



ITEM ID:	SIZE	TOTAL LENGTH (mm)	BIT LENGTH (mm)	DIAMETER (mm)
M381210-C	TPX10	49.5	23	17.9
M381215-C	TPX15	49.5	23	17.9
M381220-C	TPX20	49.5	23	17.9
M381225-C	TPX25	49.5	23	17.9
M381227-C	TPX27	49.5	23	17.9
M381230-C	TPX30	49.5	23	17.9
M381240-C	TPX40	49.5	23	17.9
M381245-C	TPX45	49.5	23	17.9
M381250-C	TPX50	49.5	23	17.9



**3/8" TX-E SOCKET**



ITEM ID:	SIZE	LENGTH (mm)	DIAMETER (mm)	DIAMETER 2 (mm)
M380710-C	E10	28	13	17
M380712-C	E12	28	15	17
M380714-C	E14	28	16.3	18
M380716-C	E16	28	20	20
M380718-C	E18	28	22	22





**1/2" SOCKET 6 PT METRIC**

ITEM ID:	SIZE	LENGTH (mm)	DIAMETER (mm)	DIAMETER 2 (mm)
M1205086-C	8	38.5	13.3	21.8
M1205106-C	10	38	15.5	21.8
M1205116-C	11	38	16.7	21.8
M1205126-C	12	38	18	21.8
M1205136-C	13	38	19.2	21.8
M1205146-C	14	38	20.5	21.8
M1205156-C	15	38	21	21.8
M1205166-C	16	38	22.5	23.3
M1205176-C	17	38	24.2	23
M1205186-C	18	38	24.7	23
M1205196-C	19	38	26.3	24
M1205206-C	20	38	27	24
M1205216-C	21	38	28	24
M1205226-C	22	40	29.8	26
M1205236-C	23	40	30.8	26
M1205246-C	24	40	31.8	26
M1205256-C	25	40	33.4	28
M1205266-C	26	40	34.8	29
M1205276-C	27	43	35.8	30
M1205286-C	28	43	37.8	31
M1205296-C	29	43	38.8	32
M1205306-C	30	43	39.8	33
M1205326-C	32	43	41.8	35
M1205336-C	33	45.5	42.8	35
M1205346-C	34	45.5	43.8	36

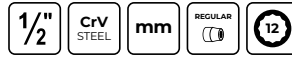
**1/2" SOCKET 12 PT METRIC**

ITEM ID:	SIZE	LENGTH (mm)	DIAMETER (mm)	DIAMETER 2 (mm)
M120508-C	8	38	13	21.8
M120509-C	9	38	14.5	21.8
M120510-C	10	38	15.5	21.8
M120511-C	11	38	16.7	21.8
M120512-C	12	38	18	21.8
M120513-C	13	38	19.2	21.8
M120514-C	14	38	20.5	21.8
M120515-C	15	38	21	21.8
M120516-C	16	38	22.5	23.3
M120517-C	17	38	24.2	23
M120518-C	18	38	24.7	23
M120519-C	19	38	26.3	24
M120520-C	20	38	27	23.7
M120521-C	21	38	28	24
M120522-C	22	40	29.8	26
M120523-C	23	40	30.8	26
M120524-C	24	40	31.8	26
M120525-C	25	40	33.4	28
M120526-C	26	40	34.8	29
M120527-C	27	43	35.8	30
M120528-C	28	43	37.8	31
M120529-C	29	43	38.8	32
M120530-C	30	43	39.8	33
M120532-C	32	43	41.8	35
M120534-C	34	45.5	43.8	36



**1/2" SOCKET 12 PT AF**

ITEM ID:	SIZE	LENGTH (mm)	DIAMETER (mm)	DIAMETER 2 (mm)
M120112-C	3/8	38	14.7	21.8
M120114-C	7/16	38	17	21.8
M120116-C	1/2	38	19	21.8
M120118-C	9/16	38	20.8	21.8
M120119-C	19/32	38	21	21.8
M120120-C	5/8	38	22.5	23.3
M120122-C	11/16	38	24.2	23.5
M120124-C	3/4	38	26.3	24
M120125-C	25/32	38	26.8	24
M120126-C	13/16	38	27.7	24
M120128-C	7/8	40	29.8	26
M120130-C	15/16	40	31.8	26
M120132-C	1	43	33.8	27.5
M120134-C	1-1/16	43	35.8	29
M120136-C	1-1/8	43	37.8	30.5
M120138-C	1-3/16	43	39.8	32.5
M120140-C	1-1/4	43	40.8	34

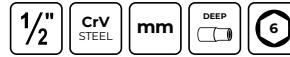
**1/2" DEEP SOCKET 6 PT METRIC**

ITEM ID:	SIZE	LENGTH (mm)	DIAMETER (mm)	DIAMETER 2 (mm)
M1206136-C	13	79	19.2	22
M1206146-C	14	79	20.5	22
M1206156-C	15	79	21.5	22
M1206166-C	16	79	22.5	23.3
M1206176-C	17	79	24.2	24.2
M1206186-C	18	79	25.4	25.4
M1206196-C	19	79	26.7	26.7
M1206246-C	24	79	31.8	31.8





**1/2" DEEP SOCKET 12 PT METRIC**



ITEM ID:	SIZE	LENGTH (mm)	DIAMETER (mm)	DIAMETER 2 (mm)
M120610-C	10	79	15.5	22
M120611-C	11	79	16.7	22
M120612-C	12	79	18	22
M120613-C	13	79	19.2	22
M120614-C	14	79	20.5	22
M120615-C	15	79	21.5	22
M120616-C	16	79	22.5	23.3
M120617-C	17	79	24.2	24.2
M120618-C	18	79	25.4	25.4
M120619-C	19	79	26.7	26.7
M120620-C	20	79	27.8	27.8
M120621-C	21	79	27.8	27.8
M120622-C	22	79	29.8	29.8
M120624-C	24	79	31.8	31.8
M120627-C	27	79	35.8	35.8
M120630-C	30	79	39.8	39.8
M120632-C	32	79	41.3	41.3
M120636-C	36	79	46	46



**1/2" HEX BIT SOCKET METRIC**



ITEM ID:	SIZE	TOTAL LENGTH (mm)	BIT LENGTH (mm)	DIAMETER (mm)
M121505-C	5	55	20.5	22
M121506-C	6	55	20.5	22
M121507-C	7	55	20.5	22
M121508-C	8	55	20.5	22
M121509-C	9	55	20.5	22
M121510-C	10	55	20.5	22
M121512-C	12	55	20.5	22
M121514-C	14	55	20.5	22
M121515-C	15	55	20.5	22
M121516-C	16	55	20.5	22
M121517-C	17	55	20.5	22
M121518-C	18	55	20.5	25
M121519-C	19	60	23	25.9





### 1/2" HEX BIT SOCKET AF



ITEM ID:	SIZE	TOTAL LENGTH (mm)	BIT LENGTH (mm)	DIAMETER (mm)
M121106-C	3/16	55	20	22
M121107-C	7/32	55	20	22
M121108-C	1/4	55	20	22
M121109-C	9/32	55	20	22
M121110-C	5/16	55	20	22
M121112-C	3/8	55	20	22
M121116-C	1/2	55	20	22
M121118-C	9/16	55	20	22
M121120-C	5/8	55	20	22



### 1/2" LONG HEX BIT SOCKET METRIC



ITEM ID:	SIZE	TOTAL LENGTH (mm)	BIT LENGTH (mm)	DIAMETER (mm)
M122505-C	5	100	65.5	22
M122506-C	6	100	65.5	22
M122506A-C	6	115	80	22
M122507-C	7	100	65.5	22
M122508-C	8	100	65.5	22
M122508A-C	8	115	80	22
M122510-C	10	100	65.5	22
M122510L-C	10	175	140	22
M122512-C	12	100	65.5	22
M122514-C	14	100	65.5	22
M122517-C	17	100	65.5	25



## Do's and Dont's of Socketry

### DO'S

- Use the right drive
- Use the correct socket size
- Check the thread direction
- Keep it clean and dry
- Use light oil on ratchet mechanisms

### DONT'S

- Do not use with impact tools
- Do not use TPX on a TX fastenings
- Do not use poles to increase leverage





**1/2" TX BIT SOCKET**



ITEM ID:	SIZE	TOTAL LENGTH (mm)	BIT LENGTH (mm)	DIAMETER (mm)
M121220T-C	TX20	55	20.5	22
M121225T-C	TX25	55	20.5	22
M121227T-C	TX27	55	20.5	22
M121230T-C	TX30	55	20.5	22
M121240T-C	TX40	55	20.5	22
M121245T-C	TX45	55	20.5	22
M121250T-C	TX50	55	20.5	22
M121255T-C	TX55	55	20.5	22
M121260T-C	TX60	55	20.5	22



**1/2" LONG TX BIT SOCKET**



ITEM ID:	SIZE	TOTAL LENGTH (mm)	BIT LENGTH (mm)	DIAMETER (mm)
M122220T-C	TX20	100	65.5	22
M122225T-C	TX25	100	65.5	22
M122227T-C	TX27	100	65.5	22
M122230T-C	TX30	100	65.5	22
M122240T-C	TX40	100	65.5	22
M122245T-C	TX45	100	65.5	22
M122250T-C	TX50	100	65.5	22
M122255T-C	TX55	100	65.5	22
M122260T-C	TX60	100	65.5	22
M122270T-C	TX70	100	65.5	22



**1/2" TX CYLINDER HEAD BIT SOCKET**



ITEM ID:	SIZE	TOTAL LENGTH (mm)	BIT LENGTH (mm)	DIAMETER (mm)
120955-C	TX55	125	87	22





### 1/2" TPX BIT SOCKET



ITEM ID:	SIZE	TOTAL LENGTH (mm)	BIT LENGTH (mm)	DIAMETER (mm)
M121220-C	TPX20	55	20.5	22
M121225-C	TPX25	55	20.5	22
M121227-C	TPX27	55	20.5	22
M121230-C	TPX30	55	20.5	22
M121240-C	TPX40	55	20.5	22
M121245-C	TPX45	55	20.5	22
M121250-C	TPX50	55	20.5	22
M121255-C	TPX55	55	20.5	22
M121260-C	TPX60	55	20.5	22



### 1/2" TX-E SOCKET



ITEM ID:	SIZE	LENGTH (mm)	DIAMETER (mm)	DIAMETER 2 (mm)
M120710-C	E10	37.8	13.1	23.5
M120711-C	E11	37.8	14.1	23.5
M120712-C	E12	37.8	14.9	23.5
M120714-C	E14	37.8	16.7	23.5
M120716-C	E16	37.8	19.1	23.5
M120718-C	E18	37.8	20.9	23.5
M120720-C	E20	37.8	23.5	23.5
M120722-C	E22	37.8	26.1	26.1
M120724-C	E24	37.8	28	28







**1/2" LONG RIBE® BIT SOCKET**



ITEM ID:	SIZE	TOTAL LENGTH (mm)	BIT LENGTH (mm)	DIAMETER (mm)
M122704-C	04	100	65	22
M122705-C	05	100	65	22
M122706-C	06	100	65	22
M122708-C	08	100	65	22
M122709-C	09	100	65	22
M122710-C	10	100	65	22
M122711-C	11	100	65	22
M122712-C	12	100	65	22
M122713-C	13	100	65	22



**1/2" LONG XZN/TRIPLE SQUARE BIT SOCKET**



ITEM ID:	SIZE	TOTAL LENGTH (mm)	BIT LENGTH (mm)	DIAMETER (mm)
M122805-C	05	100	65	22
M122806-C	06	100	65	22
M122808-C	08	100	65	22
M122809-C	09	100	65	22
M122810-C	10	100	65	22
M122812-C	12	100	65	22
M122814-C	14	100	65	22
M122816-C	16	100	65	22





### 3/4" SOCKET 6 PT METRIC



ITEM ID:	SIZE	LENGTH (mm)	DIAMETER (mm)	DIAMETER 2 (mm)
M3405196-C	19	50	29.2	33
M3405216-C	21	50	31.2	33
M3405226-C	22	50	32.2	36
M3405246-C	24	51	34.2	36
M3405266-C	26	52	36	36
M3405276-C	27	52	38	36
M3405306-C	30	54	42	38
M3405326-C	32	56	44	38
M3405336-C	33	56	46	38
M3405346-C	34	56	47	38
M3405366-C	36	58	50	38
M3405386-C	38	60	52	42
M3405416-C	41	64	56	45
M3405466-C	46	68	62	45
M3405506-C	50	72	68	48



### 3/4" SOCKET 12 PT AF



ITEM ID:	SIZE	LENGTH (mm)	DIAMETER (mm)	DIAMETER 2 (mm)
M340124-C	3/4	50	29.2	33
M340128-C	7/8	51	32.2	36.2
M340130-C	15/16	51	34.5	36.2
M340132-C	1	51	37	37
M340134-C	1-1/16	51	38.3	37
M340136-C	1-1/8	51	40	38.5
M340138-C	1-3/16	55	42	38.5
M340140-C	1-1/4	55	44	38.5
M340142-C	1-5/16	55	46	38.5
M340144-C	1-3/8	57	48	42.3
M340146-C	1-7/16	57	50	42.3
M340148-C	1-1/2	60	52.1	45.2
M340152-C	1-5/8	63	56.1	45.2
M340156-C	1-3/4	65	60	48
M340158-C	1-13/16	67	62	48
M340160-C	1-7/8	69	64	48.3
M340164-C	2	71	68.2	48.3





**3/4" HEX BIT SOCKET METRIC**



ITEM ID:	SIZE	LENGTH (mm)	DIAMETER (mm)
M341514-C	14	78.5	36
M341517-C	17	78.5	36
M341519-C	19	78.5	36
M341522-C	22	78.5	36



**1" SOCKET 12 PT METRIC**



ITEM ID:	SIZE	LENGTH (mm)	DIAMETER (mm)	DIAMETER 2 (mm)
M110536	36	65.3	51	45.2
M110541	41	70.2	57.1	45.2
M110546	46	74.5	64.6	49.4
M110550	50	75.3	69.9	55.2
M110555	55	80	76.2	57.3
M110558	58	80	79.2	57.3
M110560	60	84	82.1	57.3
M110565	65	87.3	88	57.3
M110570	70	93.4	94	68.1
M110575	75	96.1	94	68.1
M110580	80	103.6	105	68.1





**3/8" IMPACT ADAPTORS**



ITEM ID:	ADAPTOR TYPE	DRIVE 1	DRIVE 2	STANDARD
980020-C	3" Extension			DIN
980035-C	Reducing	3/8"	1/4"	DIN
980036-C	Step-up	3/8"	1/2"	DIN
980036A-C	Step-up (ANSI)	3/8"	1/2"	ANSI
980060-C	Hex bit coupler	3/8"	1/4" Hex	DIN
980086	Hex coupler	5/16" Hex	3/8"	ANSI



**1/2" IMPACT ADAPTORS**



ITEM ID:	ADAPTOR TYPE	DRIVE 1	DRIVE 2	STANDARD
920020N	3" Extension			DIN
920020AN	3" Extension (ANSI)			ANSI
920021N	5" Extension			DIN
920021AN	5" Extension (ANSI)			ANSI
920023N	10" Extension			DIN
920023AN	10" Extension (ANSI)			ANSI
920030N	Universal joint			DIN
920030AN	Universal joint (ANSI)			ANSI
920036N	Reducing	1/2"	3/8"	DIN
920036AN	Reducing	1/2"	3/8"	ANSI
920037N	Step-up	1/2"	3/4"	DIN
920037AN	Step-up	1/2"	3/4"	ANSI
920060-C	Hex bit coupler	1/2"	5/16" Hex	ANSI



**3/4" IMPACT ADAPTORS**



ITEM ID:	ADAPTOR TYPE	DRIVE 1	DRIVE 2	STANDARD
940022-C	7" Extension			DIN
940030-C	Universal joint			DIN
940037-C	Reducing	3/4"	1/2"	DIN
940085-C	Step-up	3/4"	1"	DIN



**IMPACT REDUCING ADAPTOR**



ITEM ID:	ADAPTOR TYPE	DRIVE 1	DRIVE 2	STANDARD
910086	Reducing	1"	3/4"	DIN





RETAINING RINGS AND RETAINING PINS



ITEM ID:	SIZE	LENGTH (mm)
<b>RINGS:</b>		
O95775	75 x 5.7	
O92194	19 x 4.0	
O92244	24 x 4.0	
O95034	34 x 5.0	
O95036	36 x 5.0	
O97043	43 x 7.0	
O97045	45 x 7.0	
O95046	46 x 5.0	
O97051	51 x 7.0	
O910075	75 x 10	
O9100115	115 x 10	
<b>PINS:</b>		
P92320	3	20
P92325	3	25
P90433	4	33
P90435	4	35
P90445	4	45
P90543	5.0	43
P90545	5	45
P90551	5	51
P90675	6.0	75
P906110	6	110



1/4" IMPACT SOCKET ANSI METRIC



ITEM ID:	SIZE	LENGTH (mm)	DIAMETER (mm)	DIAMETER 2 (mm)
960506-C	6	25	10.3	13.1
960507-C	7	25	12	13.1
960508-C	8	25	13.1	13.1
960510-C	10	25	15.9	15.9
960513-C	13	25	19.8	19.8



DIN Standard sockets require a retaining ring and pin to safely secure the socket to the impact tool.

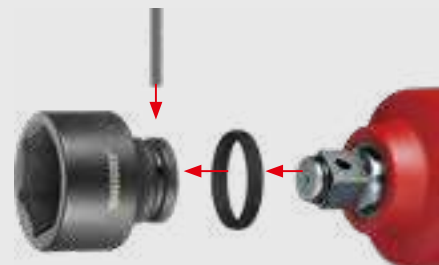



**3/8" IMPACT SOCKET ANSI METRIC**



ITEM ID:	SIZE	LENGTH (mm)	DIAMETER (mm)	DIAMETER 2 (mm)
980508-C	8	29.5	12.8	19
980510-C	10	29.5	15	19
980511-C	11	29.5	17	19
980512-C	12	29.5	19	19
980513-C	13	29.5	22	22
980514-C	14	29.5	22	22
980515-C	15	30	22	22
980516-C	16	29.5	23.8	23.8
980517-C	17	29.5	25	25
980519-C	19	29.5	27.8	27.8



**3/8" DEEP IMPACT SOCKET ANSI METRIC**



ITEM ID:	SIZE	LENGTH (mm)	DIAMETER (mm)	DIAMETER 2 (mm)
980608-C	8	63	12.8	19
980610-C	10	63	15	19
980611-C	11	63	17	19
980612-C	12	63	19	19
980613-C	13	63	22	22
980614-C	14	63	22	22
980616-C	16	63	24	24
980617-C	17	63	25	25
980619-C	19	63	27.8	27.8







**3/8" HEX BIT IMPACT SOCKET DIN METRIC**



ITEM ID:	SIZE	LENGTH (mm)	DIAMETER (mm)	RETAINING RING	RETAINING PIN
981504-C	4	52	20.8	O935202	P90320
981505-C	5	52	20.8	O935202	P90320
981506-C	6	52	20.8	O935202	P90320
981507-C	7	52	20.8	O935202	P90320
981508-C	8	52	20.8	O935202	P90320
981510-C	10	52	20.8	O935202	P90320
981512-C	12	52	20.8	O935202	P90320



**1/2" IMPACT SOCKET DIN METRIC**



ITEM ID:	SIZE	LENGTH (mm)	DIAMETER (mm)	DIAMETER 2 (mm)	RETAINING RING	RETAINING PIN
920508N	8	38	15	25	O92194	P92320
920510N	10	38	17	25	O92194	P92320
920511N	11	38	18.5	25	O92194	P92320
920512N	12	38	20	25	O92194	P92320
920513N	13	38	21	25	O92194	P92320
920514N	14	38	22.5	25	O92194	P92320
920515N	15	38	23	30	O92244	P92325
920516N	16	38	25	30	O92244	P92325
920517N1	17	38	26	30	O92244	P92325
920518N	18	38	27.5	30	O92244	P92325
920519N1	19	38	28.5	30	O92244	P92325
920520N	20	38	30	30	O92244	P92325
920521N1	21	38	31	30	O92244	P92325
920522N	22	38	32.5	30	O92244	P92325
920523N	23	38	34	30	O92244	P92325
920524N	24	38	35	30	O92244	P92325
920525N	25	45	36	30	O92244	P92325
920526N	26	45	37.5	30	O92244	P92325
920527N	27	45	38.5	30	O92244	P92325
920528N	28	47	40	30	O92244	P92325
920529N	29	47	41	30	O92244	P92325
920530N	30	50	42	30	O92244	P92325
920532N	32	50	44	30	O92244	P92325





**1/2" IMPACT SOCKET ANSI METRIC**



ITEM ID:	SIZE	LENGTH (mm)	DIAMETER (mm)	DIAMETER 2 (mm)
920510AN	10	38	17	22
920511AN	11	38	17	22
920512AN	12	38	19	22
920513AN	13	38	20	24
920514AN	14	38	21	24
920515AN	15	38	23	25
920516AN	16	38	25	25
920517AN	17	38	26	26
920518AN	18	38	28	26
920519AN	19	38	28	28
920521AN	21	38	30	30
920522AN	22	38	32	32
920524AN	24	38	36	36

**1/2" IMPACT SOCKET DIN AF**



ITEM ID:	SIZE	LENGTH (mm)	DIAMETER (mm)	DIAMETER 2 (mm)	RETAINING RING	RETAINING PIN
920112	3/8	38	16.1	24	O92194	P92320
920114	7/16	38	17.8	24	O92194	P92320
920116	1/2	38	19.9	24	O92194	P92320
920118	9/16	38	21.9	24	O92194	P92320
920120	5/8	38	24	24	O92194	P92320
920122	11/16	38	26	26	O92244	P92325
920124	3/4	38	30	30	O92244	P92325
920126	13/16	38	30	30	O92244	P92325
920128	7/8	38	32	30	O92244	P92325
920130	15/16	38	33.9	30	O92244	P92325
920132	1	40	35.6	30	O92244	P92325
920134	1-1/16	42	37.6	30	O92244	P92325
920136	1-1/8	42	39.8	30	O92244	P92325
920140	1-1/4	44	44	30	O92244	P92325





### 1/2" STUBBY IMPACT SOCKET DIN METRIC



ITEM ID:	SIZE	LENGTH (mm)	DIAMETER (mm)	DIAMETER 2 (mm)	RETAINING RING	RETAINING PIN
920710-C	10	28	18	24	O92194	P92320
920712-C	12	29	20	24	O92194	P92320
920713-C	13	30	20	24	O92194	P92320
920714-C	14	31	22	24	O92194	P92320
920715-C	15	32	24	24	O92194	P92320
920716-C	16	33	24	24	O92194	P92320
920717-C	17	34	26	26	O92244	P92325
920718-C	18	35	28	25	O92244	P92325
920719-C	19	36	28	25	O92244	P92325
920721-C	21	37	30	30	O92244	P92325
920722-C	22	38	32	30	O92244	P92325
920724-C	24	39	34	30	O92244	P92325



### 1/2" DEEP IMPACT SOCKET DIN METRIC



ITEM ID:	SIZE	LENGTH (mm)	DIAMETER (mm)	DIAMETER 2 (mm)	RETAINING RING	RETAINING PIN
920610N	10	80	17	25	O92194	P92320
920611N	11	80	18.5	25	O92194	P92320
920612N	12	80	20	25	O92194	P92320
920613N	13	80	21	25	O92194	P92320
920614N	14	80	22.5	25	O92194	P92320
920615N	15	80	23	30	O92244	P92325
920616N	16	80	25	30	O92244	P92325
920617N	17	80	26	30	O92244	P92325
920618N	18	80	27.5	30	O92244	P92325
920619N	19	80	28.5	30	O92244	P92325
920620N	20	80	30	30	O92244	P92325
920621N	21	80	31	30	O92244	P92325
920622N	22	80	32.5	30	O92244	P92325
920623N	23	80	34	30	O92244	P92325
920624N	24	80	35	30	O92244	P92325
920627N	27	80	38.5	30	O92244	P92325
920628N	28	80	40	30	O92244	P92325
920629N	29	80	40	30	O92244	P92325
920630N	30	80	42	30	O92244	P92325
920632N	32	80	44	30	O92244	P92325
920635N	35	80	48	30	O92244	P92325
920636N	36	80	50	30	O92244	P92325





**1/2" DEEP IMPACT SOCKET ANSI METRIC**



ITEM ID:	SIZE	LENGTH (mm)	DIAMETER (mm)	DIAMETER 2 (mm)
920610AN	10	78	17	22
920611AN	11	78	18	22
920612AN	12	78	19	22
920613AN	13	78	22	24
920614AN	14	78	22	24
920615AN	15	78	24	24
920616AN	16	78	24	24
920617AN	17	78	26	26
920618AN	18	78	28	28
920619AN	19	78	28	28
920621AN	21	78	30	30
920622AN	22	78	32	32
920624AN	24	78	35.8	35.8

**1/2" DEEP IMPACT SOCKET DIN AF**



ITEM ID:	SIZE	LENGTH (mm)	DIAMETER (mm)	DIAMETER 2 (mm)	RETAINING RING	RETAINING PIN
920212	3/8	78	16	24	O92194	P92320
920214	7/16	78	18	24	O92194	P92320
920216	1/2	78	20.4	24	O92194	P92320
920218	9/16	78	22	24	O92194	P92320
920220	5/8	78	24	24	O92194	P92320
920222	11/16	78	26	26	O92244	P92325
920224	3/4	78	28	28	O92244	P92325
920226	13/16	78	30	30	O92244	P92325
920228	7/8	78	32	30	O92244	P92325
920230	15/16	78	34	30	O92244	P92325
920232	1	78	36	30	O92244	P92325
920234	1-1/16	78	38	30	O92244	P92325
920236	1-1/8	78	40	30	O92244	P92325
920240	1-1/4	78	44.4	30	O92244	P92325
920242	1-5/16	80	46	30	O92244	P92325
920248	1-1/2	80	52	30	O92244	P92325





**1/2" DOUBLE ENDED IMPACT SOCKET METRIC**



ITEM ID:	SIZE	LENGTH (mm)	DIAMETER (mm)	DIAMETER 2 (mm)
9291719	17 x 19	58	26	28
9292122	21 x 22	58	30	32



**1/2" HEX IMPACT SOCKET DIN AF**



ITEM ID:	SIZE	LENGTH (mm)	DIAMETER (mm)	RETAINING RING	RETAINING PIN
921606	3/16	78	24.8	O92194	P92320
921608	1/4	78	24.8	O92194	P92320
921610	5/16	78	24.8	O92194	P92320
921612	3/8	78	24.8	O92194	P92320
921614	7/16	78	24.8	O92194	P92320
921616	1/2	78	24.8	O92194	P92320
921618	9/16	78	24.8	O92194	P92320
921620	5/8	78	24.8	O92194	P92320
921622	11/16	78	24.8	O92194	P92320
921624	3/4	78	24.8	O92194	P92320



**1/2" HEX IMPACT SOCKET DIN METRIC**



ITEM ID:	SIZE	DIAMETER (mm)	LENGTH (mm)	RETAINING RING	RETAINING PIN
921505-C	5	25	78	O92194	P92320
921506-C	6	25	78	O92194	P92320
921508-C	8	25	78	O92194	P92320
921510-C	10	25	78	O92194	P92320
921512-C	12	25	78	O92194	P92320
921514-C	14	25	78	O92194	P92320
921517-C	17	25	78	O92194	P92320
921519-C	19	25	78	O92194	P92320





**1/2" TX IMPACT SOCKET DIN**



ITEM ID:	SIZE	LENGTH (mm)	DIAMETER (mm)	DIAMETER 2 (mm)	RETAINING RING	RETAINING PIN
921210TX-C	TX10	78	6.5	25	O92194	P92320
921215TX-C	TX15	78	6.5	25	O92194	P92320
921220TX-C	TX20	78	6.5	25	O92194	P92320
921225TX-C	TX25	78	6.5	25	O92194	P92320
921227TX-C	TX27	78	6.5	25	O92194	P92320
921230TX-C	TX30	78	6.5	25	O92194	P92320
921240TX-C	TX40	78	8	25	O92194	P92320
921245TX-C	TX45	78	9	25	O92194	P92320
921250TX-C	TX50	78	10	25	O92194	P92320
921255TX-C	TX55	78	12	25	O92194	P92320
921260TX-C	TX60	78	14	25	O92194	P92320
921270TX-C	TX70	78	16	25	O92194	P92320



**1/2" XZN/TRIPLE SQUARE IMPACT SOCKET**



ITEM ID:	SIZE	LENGTH (mm)	DIAMETER (mm)	RETAINING RING	RETAINING PIN
921814	14	43	25	O92194	P92320
921816	16	43	25	O92194	P92320
921817	17	43	25	O92194	P92320
921818	18	43	25	O92194	P92320
923814	14	78	25	O92194	P92320
923816	16	78	25	O92194	P92320
923817	17	78	25	O92194	P92320
923818	18	78	25	O92194	P92320





**3/4" IMPACT SOCKET DIN METRIC**

ITEM ID:	SIZE	LENGTH (mm)	DIAMETER (mm)	DIAMETER 2 (mm)	RETAINING RING	RETAINING PIN
940519-C	19	50	33	44	O95036	P90435
940521-C	21	50	35	44	O95036	P90435
940522-C	22	50	37	44	O95036	P90435
940523-C	23	50	38	44	O95036	P90435
940524-C	24	50	39	44	O95036	P90435
940527-C	27	54	43	44	O95036	P90435
940528-C	28	54	44	44	O95036	P90435
940530-C	30	54	47	44	O95036	P90435
940532-C	32	56	48	44	O95036	P90435
940533-C	33	56	51	44	O95036	P90435
940534-C	34	56	52	44	O95036	P90435
940536-C	36	56	54	44	O95036	P90435
940538-C	38	58	57	44	O95036	P90435
940540-C	40	58	58	44	O95036	P90435
940541-C	41	58	60	44	O95036	P90435
940546-C	46	63	67	44	O95036	P90435
940550-C	50	68	71	44	O95036	P90435

**3/4" IMPACT SOCKET DIN AF**

ITEM ID:	SIZE	LENGTH (mm)	DIAMETER (mm)	DIAMETER 2 (mm)	RETAINING RING	RETAINING PIN
940122	11/16	51	29.5	41.4	O95036	P90435
940124	3/4	51	32	41.4	O95036	P90435
940126	13/16	51	35	41.4	O95036	P90435
940128	7/8	51	36	41.4	O95036	P90435
940130	15/16	51	38.5	41.4	O95036	P90435
940132	1	53	40	41.4	O95036	P90435
940134	1-1/16	53	42.5	44	O95036	P90435
940136	1-1/8	53	44	44	O95036	P90435
940138	1-3/16	53	46	44	O95036	P90435
940140	1-1/4	57	48.5	44	O95036	P90435
940142	1-5/16	57	50	44	O95036	P90435
940144	1-3/8	57	52.5	44	O95036	P90435
940146	1-7/16	57	53.5	44	O95036	P90435
940148	1-1/2	57	56	44	O95036	P90435
940150	1-9/16	58	58.5	44	O95036	P90435
940152	1-5/8	58	60	44	O95036	P90435
940154	1-11/16	62	63.5	44	O95036	P90435
940156	1-3/4	62	64.5	44	O95036	P90435
940160	1-7/8	68	68	44	O95036	P90435
940162	1-15/16	68	70	44	O95036	P90435
940164	2	68	71	44	O95036	P90435
940166	2-1/16	71	73	54	O95046	P90445
940168	2-1/8	71	75.5	54	O95046	P90445
940170	2-3/16	71	77.5	54	O95046	P90445
940172	2-1/4	73	80	54	O95046	P90445
940174	2-5/16	73	81	54	O95046	P90445
940176	2-3/8	73	83	54	O95046	P90445



### 3/4" DEEP IMPACT SOCKET DIN METRIC



ITEM ID:	SIZE	LENGTH (mm)	DIAMETER (mm)	DIAMETER 2 (mm)	RETAINING RING	RETAINING PIN
940619-C	19	95	33	44	O95036	P90435
940621-C	21	95	35	44	O95036	P90435
940622-C	22	95	37	44	O95036	P90435
940623-C	23	95	38	44	O95036	P90435
940624-C	24	95	39	44	O95036	P90435
940627-C	27	95	43	44	O95036	P90435
940630-C	30	95	47	44	O95036	P90435
940632-C	32	95	49	44	O95036	P90435
940633-C	33	95	51	44	O95036	P90435
940634-C	34	95	52	44	O95036	P90435
940636-C	36	95	54	44	O95036	P90435
940638-C	38	95	57	44	O95036	P90435
940641-C	41	95	58	44	O95036	P90435
940646-C	46	95	67	44	O95036	P90435
940650-C	50	95	71	44	O95036	P90435



### 3/4" DEEP IMPACT SOCKET DIN AF



ITEM ID:	SIZE	LENGTH (mm)	DIAMETER (mm)	DIAMETER 2 (mm)	RETAINING RING	RETAINING PIN
940224	3/4	90	32	41.4	O95034	P90433
940226	13/16	90	35	41.4	O95034	P90433
940228	7/8	90	36	41.4	O95034	P90433
940230	15/16	90	38.5	41.4	O95034	P90433
940232	1	90	40	41.4	O95034	P90433
940234	1-1/16	90	42.5	44	O95036	P90435
940236	1-1/8	90	44	44	O95036	P90435
940238	1-3/16	90	46	44	O95036	P90435
940240	1-1/4	90	48.5	44	O95036	P90435
940242	1-5/16	90	50	44	O95036	P90435
940244	1-3/8	90	52.5	44	O95036	P90435
940246	1-7/16	90	53.5	44	O95036	P90435
940248	1-1/2	90	56	44	O95036	P90435
940250	1-9/16	90	58.5	44	O95036	P90435
940252	1-5/8	90	60	44	O95036	P90435
940254	1-11/16	90	63.5	44	O95036	P90435
940256	1-3/4	90	64.5	44	O95036	P90435
940258	1-13/16	90	66	44	O95036	P90435
940260	1-7/8	90	68	44	O95036	P90435





**3/4" EXTRA LONG IMPACT SOCKET METRIC**



ITEM ID:	SIZE	LENGTH (mm)	DIAMETER (mm)	DIAMETER 2 (mm)	RETAINING RING	RETAINING PIN
940732-C	32	400	48	44	O95036	P90435



**1" IMPACT SOCKET DIN METRIC**



ITEM ID:	SIZE	LENGTH (mm)	DIAMETER (mm)	DIAMETER 2 (mm)	RETAINING RING	RETAINING PIN
910524	24	58	41	54	O97045	P90545
910527	27	58	46	54	O97045	P90545
910530	30	60	49	54	O97045	P90545
910532	32	60	52	54	O97045	P90545
910533	33	60	53	54	O97045	P90545
910534	34	60	55	54	O97045	P90545
910536	36	65	56	54	O97045	P90545
910538	38	65	59	54	O97045	P90545
910541	41	67	63	54	O97045	P90545
910546	46	74	69	54	O97045	P90545
910550	50	80	74	54	O97045	P90545
910555	55	84	80	54	O97045	P90545
910560	60	87	86	54	O97045	P90545
910565	65	90	92	54	O97045	P90545
910570	70	96	99	54	O97045	P90545
910575	75	98	104	60	O97051	P90551
910580	80	100	109	60	O910075	P90675
910585	85	100	115	86	O910075	P90675
910590	90	100	119	86	O910075	P90675
910595	95	100	130	86	O910075	P90675



**3/4" HEX IMPACT SOCKET DIN METRIC**



ITEM ID:	SIZE	LENGTH (mm)	DIAMETER (mm)	RETAINING RING	RETAINING PIN
941519-C	19	90	44	O95036	P90435
941522-C	22	90	44	O95036	P90435
941524-C	24	90	44	O95036	P90435





### 1" DEEP IMPACT SOCKET DIN METRIC



ITEM ID:	SIZE	LENGTH (mm)	DIAMETER (mm)	DIAMETER 2 (mm)	RETAINING RING	RETAINING PIN
910627R	27	100	46	54	O97045	P90545
910630R	30	100	50	54	O97045	P90545
910632R	32	100	52	54	O97045	P90545
910633R	33	100	53	54	O97045	P90545



### 1" EXTRA LONG IMPACT SOCKET METRIC



ITEM ID:	SIZE	LENGTH (mm)	DIAMETER (mm)	DIAMETER 2 (mm)	RETAINING RING	RETAINING PIN
910732	32	400	48	54	O97045	P90545



### 1" DEEP THINWALL IMPACT SOCKET DIN METRIC



ITEM ID:	SIZE	LENGTH (mm)	DIAMETER (mm)	DIAMETER 2 (mm)	RETAINING RING	RETAINING PIN
910624	24	100	38	54	O97045	P90545
910627	27	100	43	54	O97045	P90545
910628	28	100	43	54	O97045	P90545
910630	30	100	45	54	O97045	P90545
910632	32	100	47	54	O97045	P90545
910633	33	100	49	54	O97045	P90545
910636	36	100	52	54	O97045	P90545





### 1-1/2" IMPACT SOCKET DIN METRIC



ITEM ID:	SIZE	LENGTH (mm)	DIAMETER (mm)	DIAMETER 2 (mm)	RETAINING RING	RETAINING PIN
912041	41	80	69	86	O910075	P90675
912046	46	84	75	86	O910075	P90675
912050	50	87	80	86	O910075	P90675
912055	55	90	86	86	O910075	P90675
912060	60	95	91	86	O910075	P90675
912065	65	100	100	86	O910075	P90675
912070	70	105	104	86	O910075	P90675
912075	75	105	105	86	O910075	P90675
912080	80	110	116	86	O910075	P90675
912085	85	110	123	86	O910075	P90675
912090	90	112	129	86	O910075	P90675
912095	95	112	136	127	O9100115	P906110
912100	100	115	142	127	O9100115	P906110
912105	105	120	148	127	O9100115	P906110
912110	110	124	154	127	O9100115	P906110
912115	115	128	161	127	O9100115	P906110
912120	120	132	167	127	O9100115	P906110
912125	125	136	173	127	O9100115	P906110
912130	130	140	180	127	O9100115	P906110







# TORQUE TOOLS

## MAKE THE PROFESSIONAL CHOICE

TengTools torque wrenches have become an industry standard. Whether you choose the classic version that has been a favourite for many years or the new P-Series range designed for the industrial and maintenance sectors you are guaranteed quality, accuracy and reliability as standard.



### TORQUE WRENCH

Click type mechanism to signal when the required torque is reached

Equipped with an in-built angular gauge for when tightening at specific angle is required

Reversible 24 teeth ratchet mechanism in according to DIN3122 giving 15° increments

Switch for changing between left and right-hand action. Designed to torque right hand only. Bi-Directional models are available.

Scale in Nm & ft/lb

Twist locking to ensure the set torque is maintained

Accurate to +/- 4% and conforms to ISO6789



### TORQUE WRENCH PLUS

Quick release 72 teeth ratchet mechanism with twist reverse manufactured to DIN3122

Compact head for easier use in confined spaces

Click type mechanism to signal when the required torque is reached

Industrial quality grade steel tube for added stability

Ergonomic bi-material grip for maximum comfort when in use

Easy to read Nm scale that is simple to adjust

Locking button to ensure the set torque is securely maintained

Hanging facility which can be used together with a fall protection equipment

Accurate to +/- 4% and conforms to ISO6789





**1/4" TORQUE SCREWDRIVER**



ITEM ID:	Nm	SCALE RESOLUTION	ACCURACY	CERTIFICATE	LENGTH (mm)	SHAFT L (mm)
1492TSD	1-5	0.02	± 6%	Factory	215	84
1492TSD-CT	1-5	0.02	± 6%	New	215	84



**1/4" TORQUE WRENCH**



ITEM ID:	NO. OF TEETH	Nm	ft/lb	SCALE RESOLUTION	ACCURACY	CERTIFICATE	LENGTH (mm)
1492AG-E	24	5-25	4-18	0.1	± 4%	Factory	277
1492AG-CT	24	5-25	4-18	0.1	± 4%	New	277



**INSULATED TORQUE SCREWDRIVER**



ITEM ID:	Nm	SCALE RESOLUTION	ACCURACY	CERTIFICATE	LENGTH (mm)	SHAFT L (mm)
1492TVSD	1-5	0.02	± 6%	Factory	213	82
1492TVSD-CT	1-5	0.02	± 6%	New	213	82



**NEW**

**1/4" TORQUE WRENCH PLUS**



ITEM ID:	NO. OF TEETH	Nm	SCALE RESOLUTION	ACCURACY	CERTIFICATE	LENGTH (mm)
1492P015	72	3-15	0.4	± 4%	Factory	190
1492P030	72	6-30	0.4	± 4%	Factory	215





### 3/8" TORQUE WRENCH



ITEM ID:	NO. OF TEETH		SCALE			CERTIFICATE	LENGTH (mm)
	Nm	ft/lb	RESOLUTION	ACCURACY			
3892AG-E1	24	5-25	4-18	0.5	± 4%	Factory	277
3892AG1-CT	24	5-25	4-18	0.5	± 4%	New	277
3892AG-E3	24	20-110	15-81	0.5	± 4%	Factory	368
3892AG3-CT	24	20-110	15-81	0.5	± 4%	New	368



### DIGITAL TORQUE WRENCH



ITEM ID:	NO. OF TEETH		SCALE			CERTIFICATE	LENGTH (mm)
	Nm	ft/lb	RESOLUTION	ACCURACY			
3892D100	45	10-100	7-75	0.1	± 1%	Factory	465
3892D100-CT	45	10-100	7-75	0.1	± 1%	New	465



## Do's and Dont's of Torque Wrenches

### DO'S

- **Use carefully:** Torque wrenches are a measuring instrument and need to be treated with care
- **Reset torque:** After use set the torque to its lowest setting. If you don't over time the springs inside the wrench can lose their normal tension
- **Store Safely:** All torque instruments should be stored in their original case
- **Keep wrench maintained:** Torque wrenches should be cleaned and calibrated on a yearly basis

### DONT'S

- **Use as a power bar:** Torque wrenches should never be used as a power bar to shift stubborn fastenings
- **Abuse your wrench:** Do not drop your torque wrench or overload the wrench with a pipe extension
- **Store in conditions that lead to corrosion:** Avoid any storage locations that are subject to high or low temperatures and high humidity
- **Use without PPE:** We recommend safety glasses when using any torque wrench or torque product





**NEW**



**3/8" TORQUE WRENCH PLUS**



ITEM ID:	NO. OF TEETH	Nm	SCALE RESOLUTION	ACCURACY	CERTIFICATE	LENGTH (mm)
3892P030	72	6-30	0.2	± 4%	Factory	215
3892P060	72	12-60	0.5	± 4%	Factory	380
3892P060-CT	72	12-60	0.5	± 4%	New	380
3892P100	72	20-100	0.5	± 4%	Factory	410
3892P100-CT	72	20-100	0.5	± 4%	New	410

**1/2" TORQUE WRENCH**

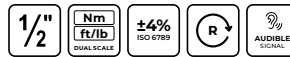

ITEM ID:	NO. OF TEETH	Nm	ft/lb	SCALE RESOLUTION	ACCURACY	CERTIFICATE	LENGTH (mm)
1292AG-EP	24	40-210	30-150	1	± 4%	Factory	465
1292AGP-CT	24	40-210	30-150	1	± 4%	New	465
1292AG-E4	24	70-350	50-250	1	± 4%	Factory	632
1292AG4-CT	24	70-350	50-250	1	± 4%	New	632



**1/2" TORQUE WRENCH BI-DIRECTIONAL**



ITEM ID:	NO. OF TEETH	Nm	ft/lb	SCALE RESOLUTION	ACCURACY	CERTIFICATE	LENGTH (mm)
1292AG-ER	24	40-210	30-150	1	± 4%	Factory	465
1292AGR-CT	24	40-210	30-150	1	± 4%	New	465
1292AG-E4R	24	70-350	50-250	1	± 4%	Factory	632
1292AG4R-CT	24	70-350	50-250	1	± 4%	New	632





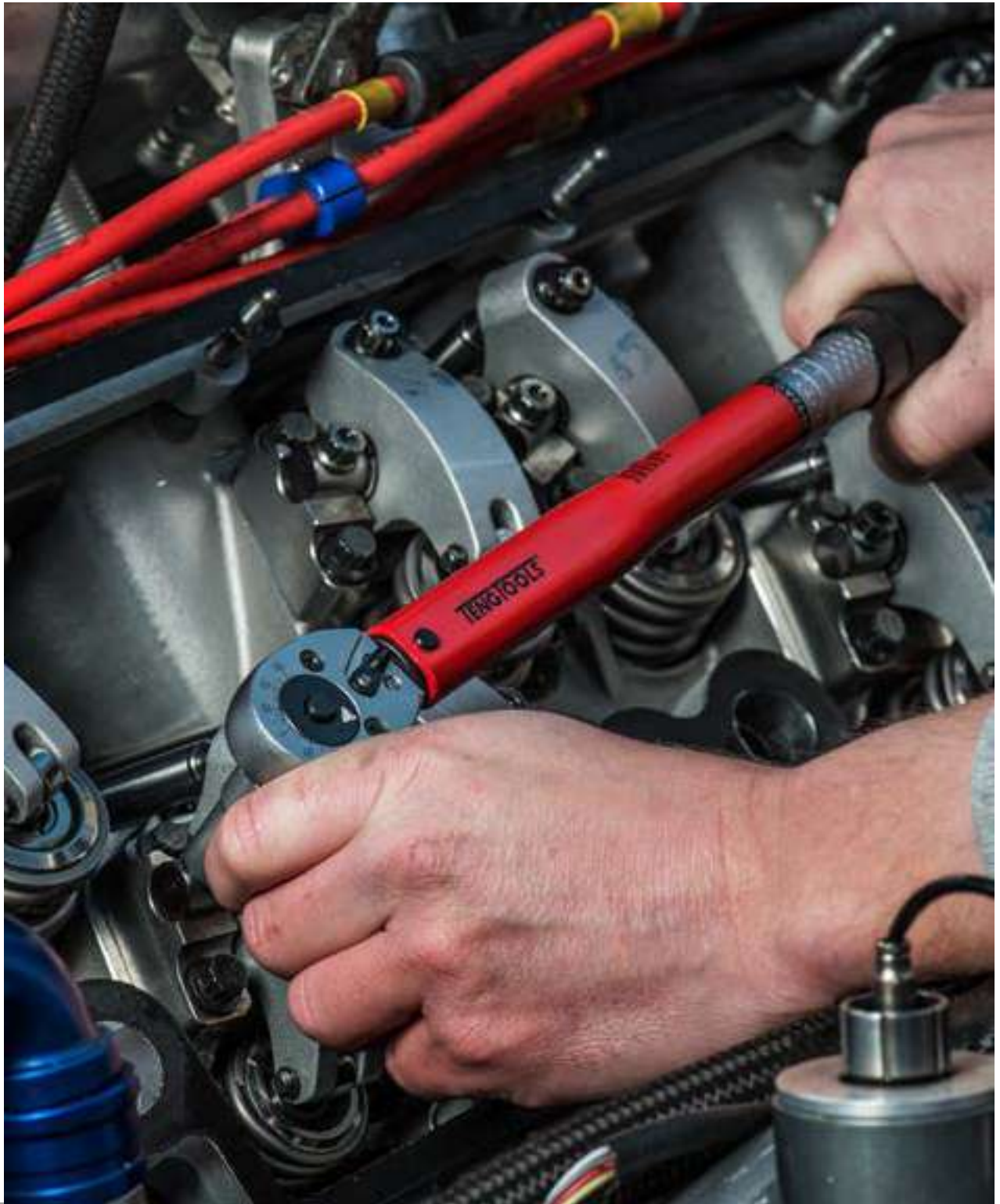





**1/2" TORQUE WRENCH PLUS**



ITEM ID:	NO. OF TEETH	Nm	SCALE RESOLUTION	ACCURACY	CERTIFICATE	LENGTH (mm)
1292P100	72	20-100	0.5	± 4%	Factory	410
1292P100-CT	72	20-100	0.5	± 4%	New	410
1292P200	72	40-200	1	± 4%	Factory	490
1292P200-CT	72	40-200	1	± 4%	New	490
1292P320	72	60-320	2	± 4%	Factory	560
1292P320-CT	72	60-320	2	± 4%	New	560

**DIGITAL TORQUE WRENCH**



ITEM ID:	NO. OF TEETH	Nm	ft/lb	SCALE RESOLUTION	ACCURACY	CERTIFICATE	LENGTH (mm)
1292D200	45	20-200	15-150	0.1	± 1%	Factory	548
1292D200-CT	45	20-200	15-150	0.1	± 1%	New	548





**3/4" TORQUE WRENCH**



ITEM ID:	NO. OF TEETH	SCALE		RESOLUTION	ACCURACY	CERTIFICATE	LENGTH (mm)
		Nm	ft/lb				
3492AG-E	24	65-450	48-330	5	± 4%	Factory	850
3492AG-CT	24	65-450	48-330	5	± 4%	New	850
3492AG-E1	24	140-700	100-500	2.5	± 4%	Factory	1065
3492AG1-CT	24	140-700	100-500	2.5	± 4%	New	1065
3492AG-E2	24	140-980	100-700	3.5	± 4%	Factory	1213
3492AG2-CT	24	140-980	100-700	3.5	± 4%	New	1213



**3/4" TORQUE WRENCH BI-DIRECTIONAL**



ITEM ID:	NO. OF TEETH	SCALE		RESOLUTION	ACCURACY	CERTIFICATE	LENGTH (mm)
		Nm	ft/lb				
3492AG-ER	24	65-450	48-330	5	± 4%	Factory	850
3492AGR-CT	24	65-450	48-330	5	± 4%	New	850



**3/4" TORQUE WRENCH PLUS**



ITEM ID:	NO. OF TEETH	Nm	SCALE		ACCURACY	CERTIFICATE	LENGTH (mm)
			RESOLUTION	ACCURACY			
3492P500	72	100-500	2.5	± 4%	Factory	790	
3492P500-CT	72	100-500	2.5	± 4%	New	790	
3492P1000	72	200-1000	5	± 4%	Factory	1243	



**NEW**



**1" TORQUE WRENCH PLUS**



ITEM ID:	NO. OF TEETH	Nm	SCALE		ACCURACY	CERTIFICATE
			RESOLUTION	ACCURACY		
1192P1000	72	200-1000	5	± 4%	Factory	
1192P1500	72	300-1500	10	± 4%	Factory	
1192P2000	72	400-2000	10	± 4%	Factory	





**TORQUE WRENCH REPAIR KITS**

ITEM ID:	DRIVE	TORQUE WRENCH
1492AGERK	1/4"	1492AG-E
1492P01SRK	1/4"	1492P015/030
3892AG1RK	3/8"	3892AG-E1
3892AG3RK	3/8"	3892AG-E3
3892P030RK	3/8"	3892P030
3892P060RK-1	3/8"	3892P060/100
1292AGERK	1/2"	1292AG-EP
1292AGERRK	1/2"	1292AG-ER
1292AG4RK	1/2"	1292AG-E4
1292AG4RRK	1/2"	1292AG-E4R
1292P100RK-1	1/2"	1292P100
1292P200RK-1	1/2"	1292P200/320
3492AGERRK	3/4"	3492AG-ER
3492AGERK	3/4"	3492AG-E
3492P500RK-1	3/4"	3492P500
1192P1000RK	1"	1192P1000
1192P1500RK	1"	1192P1500/2000



**INSERT TORQUE WRENCHES**



ITEM ID:	Nm	INSERT TOOL SIZE	SCALE RESOLUTION	ACCURACY	CERTIFICATE	LENGTH (mm)
1292P912	20-100	9 x 12 mm	0.5	± 4%	Factory	400
1292P912-CT	20-100	9 x 12 mm	0.5	± 4%	New	400
1292P418	40-200	14 x 18 mm	1	± 4%	Factory	560
1292P418-CT	40-200	14 x 18 mm	1	± 4%	New	560



**INSERT RATCHET HEADS**

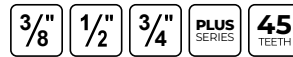

ITEM ID:	DRIVE SIZE	INSERT TOOL SIZE	REVERSE DIRECTION	NO. OF TEETH	L (mm)	LI (mm)	W (mm)	H (mm)
3892CQ100R	3/8"	9 x 12 mm	Push twist	45	36.3	20	35	36.5
1292CQ200R	1/2"	14 x 18 mm	Push twist	45	70.5	24.4	42.5	46
3492CQ500R	3/4"	14 x 18 mm	Push twist	45	98	36	68.8	69.8



**OPEN ENDED INSERT SPANNERS 9 X 12**

ITEM ID:	SIZE	INSERT TOOL SIZE	L (mm)	LI (mm)	H (mm)	W (mm)
690510	10	9 x 12 mm	39	18	15	30
690511	11	9 x 12 mm	39	18	15	30
690512	12	9 x 12 mm	40	18	16	30
690513	13	9 x 12 mm	42	20	16	30
690514	14	9 x 12 mm	42	20	17	35
690515	15	9 x 12 mm	43	20	17	35
690516	16	9 x 12 mm	43	20	18	38
690517	17	9 x 12 mm	44	20	18	38
690518	18	9 x 12 mm	46	22	18	42
690519	19	9 x 12 mm	46	22	18	42



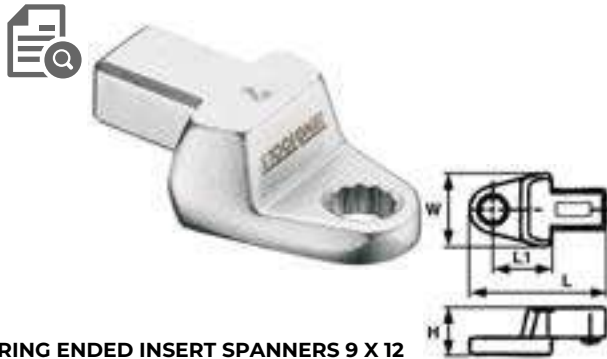

RING ENDED INSERT SPANNERS 9 X 12

ITEM ID:	SIZE	INSERT TOOL SIZE	L (mm)	L1 (mm)	H (mm)	W (mm)
690710	10	9 x 12 mm	45	18	16	26.5
690711	11	9 x 12 mm	45	18	16	26.5
690712	12	9 x 12 mm	46	18	16	26.7
690713	13	9 x 12 mm	49	20	16	27.2
690714	14	9 x 12 mm	50	20	18	27
690715	15	9 x 12 mm	50	20	18	27
690716	16	9 x 12 mm	50	20	18	27
690717	17	9 x 12 mm	54	22	18	28.6
690718	18	9 x 12 mm	54	22	18	28.6
690719	19	9 x 12 mm	54	22	18	28.6



OPEN ENDED INSERT SPANNERS 14 X 18

ITEM ID:	SIZE	INSERT TOOL SIZE	L (mm)	L1 (mm)	H (mm)	W (mm)
690613	13	14 x 18 mm	63	32	21	35
690614	14	14 x 18 mm	63	32	22	35
690615	15	14 x 18 mm	64	32	23	35
690616	16	14 x 18 mm	64	32	23	38
690617	17	14 x 18 mm	64	32	23	38
690618	18	14 x 18 mm	65	32	24	42
690619	19	14 x 18 mm	65	32	25	42
690621	21	14 x 18 mm	66	32	25	50
690622	22	14 x 18 mm	66	32	26	53
690624	24	14 x 18 mm	67	32	26	53
690626	26	14 x 18 mm	70	33	27	60
690627	27	14 x 18 mm	70	34	27	60
690629	29	14 x 18 mm	74	36	28	66
690630	30	14 x 18 mm	74	36	28	66
690632	32	14 x 18 mm	77	38	29	66
690634	34	14 x 18 mm	82	43	29	73
690636	36	14 x 18 mm	82	42	29	73
690638	38	14 x 18 mm	82	41	29	73
690640	40	14 x 18 mm	83	42	29	82
690641	41	14 x 18 mm	84	42	29	82
690642	42	14 x 18 mm	83	42	29	82
690644	44	14 x 18 mm	86	41	29	91
690646	46	14 x 18 mm	86	43	29	91



**Recalculate new torque setting if required:**

**New Torque = P x Ln / Le**

- P = Desired Torque
- Ln = Normal Length
- Le = Extended Length





**RING ENDED INSERT SPANNERS 14 X 18**

ITEM ID:	SIZE	INSERT TOOL SIZE	L (mm)	L1 (mm)	H (mm)	W (mm)
690813	13	14 x 18 mm	72	32	22	38
690814	14	14 x 18 mm	72	32	22	38
690815	15	14 x 18 mm	73	32	22	38
690816	16	14 x 18 mm	73	32	24	38
690817	17	14 x 18 mm	73	32	24	38
690818	18	14 x 18 mm	75	32	24	44
690819	19	14 x 18 mm	75	32	24	44
690821	21	14 x 18 mm	76	32	26	41
690822	22	14 x 18 mm	77	32	25	42
690824	24	14 x 18 mm	78	32	26	42
690826	26	14 x 18 mm	78	32	26	42
690827	27	14 x 18 mm	82	34	27	43.4
690829	29	14 x 18 mm	85	36	28	43.3
690830	30	14 x 18 mm	87	36	28	47.3
690832	32	14 x 18 mm	87	36	29	47.3
690834	34	14 x 18 mm	90	38	29	50
690836	36	14 x 18 mm	91	38	29	52
690838	38	14 x 18 mm	94	40	31	54.6
690840	40	14 x 18 mm	93	40	30	54.6
690841	41	14 x 18 mm	99	42	32	60
690842	42	14 x 18 mm	99	42	32	60
690844	44	14 x 18 mm	99	44	31	60
690846	46	14 x 18 mm	103	42	32	64.8



**3/8" CROW FOOT WRENCH**

3/8"

ITEM ID:	SIZE (mm)	JAW DIAMETER (mm)	LENGTH (mm)	HEIGHT (mm)	WEIGHT (g)
M386510-C	10	21.3	32.3	4.8	20
M386511-C	11	23.1	34.3	5.2	22
M386513-C	13	25.5	36.2	5.6	27
M386514-C	14	26.9	37.4	6	32
M386515-C	15	30.2	40	6.2	37
M386517-C	17	33.3	41.3	6.7	55
M386518-C	18	33.3	41.3	6.7	57
M386519-C	19	38.1	45.5	8.5	61
M386512-C	12	38.1	45.5	8.5	24
M386516-C	16	39.6	47.6	8.5	37



**1/2" TORQUE STICK**

1/2"

ITEM ID:	TORQUE (Nm)	LENGTH (mm)
923090	90	200
923110	110	200
923120	120	200
923140	140	200





### PRESET TORQUE SPANNER



ITEM ID:	SIZE	PRE-SET TORQUE	ACCURACY	L (mm)	W (mm)
TQS018	17	18	± 4%	220	38
TQS042	22	42	± 4%	230	47.2
TQS055	26	55	± 4%	285	54.9
TQS065	29	65	± 4%	290	61.9



### TORQUE SPANNER SET 4 PIECES



#### CONTENTS

- » Preset Torque Spanner
- » 17 mm - 18 Nm
- » 22 mm - 42 Nm
- » 26 mm - 55 Nm
- » 29 mm - 65 Nm

Item ID: ACD01



### ANGULAR GAUGE

- For measuring the degree of turn
- For use when after tightening of stretch bolts with torque wrenches that do not have an in-built angular gauge
- A static read off point, fixing magnet and a pair of angle scales make it possible to take a reading in most situations

Item ID: TQAG



### TORQUE MULTIPLIER 1:3

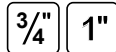

ITEM ID:	INPUT DRIVE	OUTPUT DRIVE	MAX TORQUE (Nm)	MAX TORQUE (ft/lb)	RATIO	DIAMETER	WEIGHT (g)
MP1400	1/2"	3/4"	1500	1100	1:3	69	2237
MP2700	3/4"	1"	3000	2200	1:3	92	4834







**TORQUE MULTIPLIER SUPPORT LEG**

ITEM ID:		WEIGHT (g)
MPSL01	Torque Multiplier Support Leg MP1400	1209
MPSL02	Torque Multiplier Support Leg MP2700	1581



**DIGITAL TORQUE TESTER PRO**



ITEM ID:	PLUG TYPE	RANGE	ACCURACY	DEPTH (mm)	WIDTH (mm)	HEIGHT (mm)	WEIGHT (g)
TORQ99U	UK	10-400	± 1%	200	160	85	4180
TORQ99E	EU	10-400	± 1%	200	160	85	4180
TORQ99A	AUS/NZ	10-400	± 1%	200	160	85	4180



**TORQUE MULTIPLIER 1:10**

3/4"

ITEM ID:	INPUT DRIVE	OUTPUT DRIVE	MAX TORQUE (Nm)	MAX TORQUE (ft/lb)	RATIO	WEIGHT (g)
MP91500	1/2"	3/4"	1500	1100	1:10	2079

**REPAIR KIT MP91500**

ITEM ID:	
MP91500RK	Includes a set of replacement parts for the gear mechanism



**DIGITAL TORQUE TESTER**

ITEM ID:	PLUG TYPE	RANGE	ACCURACY	DEPTH (mm)	WIDTH (mm)	HEIGHT (mm)	WEIGHT (g)
TORQ02U	UK	1.5-30	± 1%	205	155	76	2940
TORQ03U	UK	7.5-150	± 1%	205	155	76	3940
TORQ04U	UK	25-500	± 1%	205	155	76	4060
TORQ05U	UK	50-1000	± 1%	205	155	76	4060
TORQ02	EU	1.5-30	± 1%	205	155	76	2940
TORQ03	EU	7.5-150	± 1%	205	155	76	3940
TORQ04	EU	25-500	± 1%	205	155	76	4060
TORQ05	EU	50-1000	± 1%	205	155	76	4060
TORQ02A	AUS/NZ	1.5-30	± 1%	205	155	76	2940
TORQ03A	AUS/NZ	7.5-150	± 1%	205	155	76	3940
TORQ04A	AUS/NZ	25-500	± 1%	205	155	76	4060
TORQ05A	AUS/NZ	50-1000	± 1%	205	155	76	4060





### TORQUE TESTER STAND

ITEM ID:	DEPTH (mm)	WIDTH (mm)	HEIGHT (mm)	WEIGHT (g)
TORQS01	570	340	950	16460



### TORQUE TESTER PRINTER AND STAND

ITEM ID:	PLUG TYPE	DEPTH (mm)	WIDTH (mm)	HEIGHT (mm)	WEIGHT (g)
TORQU	UK	570	340	950	20568
TORQ	EU	570	340	950	20568
TORQA	AUS/NZ	570	340	950	20568



### TORQUE TESTER PRINTER

ITEM ID:	PLUG TYPE	DEPTH (mm)	WIDTH (mm)	HEIGHT (mm)	WEIGHT (g)
TORP0IU	UK	220	180	95	2180
TORP0IE	EU	220	180	95	2180
TORP0IA	AUS/NZ	220	180	95	2180



# SPANNERS & WRENCHES

## QUALITY AS STANDARD

Our range has been developed over many years with DIN and ISO standards as the lowest benchmark when it comes to quality and size tolerances. This is a policy that has resulted in many top positions on best-buy lists in consumer and trade magazines. The range includes many different types of spanners for most application areas and personal taste.



### COMBINATION SPANNERS

High mechanical performance and optimized for increased accessibility complying with DIN and ISO standards

Manufactured and designed in accordance with DIN3113A in high grade chrome vanadium steel

Size clearly marked on the side of the spanner for easy & quick visibility

The ring head is offset 15° to facilitate use even on flat surfaces

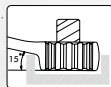

TengTools "Hip Grip" feature means the contact surface grips on the flat surfaces of the nut or bolt rather than on the corner



### RATCHETING SPANNERS

'R' range contains a lever to quickly switch between left and right-hand action. With the 'RS' range you flip the spanner over to change ratcheting direction.

'R' range is offset at 15° for use against flat surfaces while the 'RS' range is straight to reach the nut flat







## COMBINATION SPANNER METRIC



ITEM ID:	SIZE	LENGTH (mm)	JAW DIAMETER (mm)	JAW HEIGHT (mm)	RING DIAMETER (mm)	RING HEIGHT (mm)
6005055	5.5	95	13.6	3.5	8.9	4.1
600506	6	100	15.5	4	10.1	4.7
600507	7	110	17	4	11.5	5
600508	8	120	19.2	4.5	12.8	5.5
600509	9	130	21.2	4.5	14.2	5.9
600510	10	140	23.2	5	15.6	6.5
600511	11	150	25.3	5.4	16.9	6.9
600512	12	160	27.2	5.5	18.3	7.3
600513	13	170	29.4	5.9	19.7	7.8
600514	14	180	31.5	6.2	21.2	8.3
600515	15	190	33.2	6.4	22.5	8.6
600516	16	200	34.7	6.7	24	8.9
600517	17	210	36.5	6.9	25.3	9.3
600518	18	220	38.7	7.2	26.8	9.9
600519	19	230	40.7	7.4	28.1	10.5
600520	20	240	43.1	7.7	29.7	10.9
600521	21	250	44.8	8	31.3	11.3
600522	22	260	46.9	8.2	32.6	11.5
600523	23	270	48.3	8.4	34.2	11.8
600524	24	280	50.4	8.7	35.5	12.1

ITEM ID:	SIZE	LENGTH (mm)	JAW DIAMETER (mm)	JAW HEIGHT (mm)	RING DIAMETER (mm)	RING HEIGHT (mm)
600525	25	290	52	8.9	36.9	12.5
600526	26	300	53.6	9.2	38.2	12.8
600527	27	310	55.7	9.4	39.6	13.1
600528	28	320	57.6	9.7	40.9	13.3
600529	29	330	59.7	9.9	42.3	13.5
600530	30	340	61.8	10.1	43.7	13.7
600532	32	360	65.8	10.4	46.4	14.3
600533	33	380	69.2	10.7	48.8	15
600534	34	380	69.2	10.7	48.8	15
600536	36	410	74	13.5	53.5	19.2
600538	38	430	77	15	56	20.4
600541	41	460	84	16	61	21.6
600546	46	500	92	17	66	23
600550	50	540	102	18	73	24.6
600555	55	560	118	28	86	21.5
600558	58	600	126	30	94	23.5
600560	60	600	126	30	94	23.5
600565	65	680	148	32	108	25
600570	70	680	148	32	108	25





**COMBINATION SPANNER AF**



ITEM ID:	SIZE	LENGTH (mm)	JAW DIAMETER (mm)	JAW HEIGHT (mm)	RING DIAMETER (mm)	RING HEIGHT (mm)
600108	1/4	100	15.5	4	10.1	4.7
600110	5/16	120	19.2	4.5	12.8	5.5
600112	3/8	140	23.2	5	15.6	6.5
600114	7/16	150	25.3	5.4	16.9	6.9
600116	1/2	170	29.4	5.9	19.7	7.8
600118	9/16	180	31.5	6.2	21.2	8.3
600120	5/8	200	34.7	6.7	24	8.9
600122	11/16	210	36.5	6.9	25.3	9.3
600124	3/4	230	40.7	7.4	28.1	10.5
600126	13/16	250	44.8	8	31.3	11.3
600128	7/8	260	46.9	8.2	32.6	11.5
600130	15/16	280	50.4	8.7	35.5	12.1
600132	1	290	52	8.9	36.9	12.5
600134	1-1/16	310	55.7	9.4	39.6	13.1
600136	1-1/8	330	57.6	9.7	40.9	13.3
600140	1-1/4	360	65.8	10.4	46.4	14.3
600142	1-5/16	380	69.2	10.7	48.8	15
600144	1-3/8	410	74	13.5	53	16.2
600146	1-7/16	410	74	13.5	53	19.2
600148	1-1/2	430	77	15	56	20.4
600152	1-5/8	460	84	16	61	21.6
600156	1-3/4	500	92	17	66	23
600160	1-7/8	540	102	18	73	24.6



**COMBINATION SPANNER SET 8-19 mm 12 PIECES**



**CONTENTS**

- » Combination Spanner Metric  
8, 9, 10, 11, 12, 13, 14, 15, 16, 17, 18, 19

Item ID: **6512N**



**COMBINATION SPANNER SET 8-22 mm 12 PIECES**



**CONTENTS**

- » Combination Spanner Metric  
8, 9, 10, 11, 12, 13, 14, 15, 16, 17, 19, 22

Item ID: **6512**





**COMBINATION SPANNER SET 6-22 mm 17 PIECES****17**  
PIECES**mm****CONTENTS**

- » Combination Spanner Metric  
6, 7, 8, 9, 10, 11, 12, 13, 14, 15, 16, 17, 18, 19, 20, 21, 22

Item ID: **6517****COMBINATION SPANNER SET 8-19 mm TOOL ROLL 10 PIECES****10**  
PIECES**mm****CONTENTS**

- » Combination Spanner Metric  
8, 9, 10, 11, 12, 13, 14, 15, 17, 19

Item ID: **6510MM****COMBINATION SPANNER SET 6-32 mm 21 PIECES****21**  
PIECES**mm****CONTENTS**

- » Combination Spanner Metric  
6, 7, 8, 9, 10, 11, 12, 13, 14, 15, 16, 17, 18, 19, 20, 21, 22, 24, 27, 30, 32

Item ID: **6521****COMBINATION SPANNER SET 8-19 mm TOOL ROLL 12 PIECES****12**  
PIECES**mm****CONTENTS**

- » Combination Spanner Metric  
8, 9, 10, 11, 12, 13, 14, 15, 16, 17, 18, 19

Item ID: **6512MM1**

**COMBINATION SPANNER SET 5.5-19 mm TOOL ROLL  
15 PIECES****15**  
PIECES **mm****CONTENTS**

- » Combination Spanner Metric  
6, 7, 8, 9, 10, 11, 12, 13, 14, 15, 16, 17, 18, 19, 5.5

Item ID: **6515MM****COMBINATION SPANNER SET 20-32 mm TOOL ROLL  
12 PIECES****12**  
PIECES **mm****CONTENTS**

- » Combination Spanner Metric  
21, 22, 23, 24, 25, 26, 27, 28, 29, 30, 32, 33

Item ID: **6512MM****COMBINATION SPANNER SET 6-22 mm TOOL ROLL  
17 PIECES****17**  
PIECES **mm****CONTENTS**

- » Combination Spanner Metric  
6, 7, 8, 9, 10, 11, 12, 13, 14, 15, 16, 17, 18, 19, 20, 21, 22

Item ID: **6517MM****COMBINATION SPANNER SET 6-32 mm TOOL ROLL  
32 PIECES****26**  
PIECES **mm****CONTENTS**

- » Combination Spanner Metric  
6, 7, 8, 9, 10, 11, 12, 13, 14, 15, 16, 17, 18, 19, 20, 21, 22, 23, 24, 25, 26, 27, 28, 29, 30, 32

Item ID: **6526MM**



**COMBINATION SPANNER SET 33-50 mm TOOL ROLL  
7 PIECES**

**7**  
PIECES **mm**

**CONTENTS**

- » Combination Spanner Metric  
33, 34, 36, 38, 41, 46, 50

Item ID: **6507JMM**



**COMBINATION SPANNER SET 13/16"-1 1/4" TOOL ROLL  
7 PIECES**

**7**  
PIECES **AF**

**CONTENTS**

- » Combination Spanner AF  
13/16, 7/8, 15/16, 1, 1-1/16, 1-1/8, 1-1/4

Item ID: **6507AF**



**COMBINATION SPANNER SET 1/4"-3/4" TOOL ROLL  
9 PIECES**

**9**  
PIECES **AF**

**CONTENTS**

- » Combination Spanner AF  
1/4, 5/16, 3/8, 7/16, 1/2, 9/16, 5/8, 11/16, 3/4

Item ID: **6509AF**



**COMBINATION SPANNER SET 1 5/16"-1 7/8" TOOL ROLL  
7 PIECES**

**7**  
PIECES **AF**

**CONTENTS**

- » Combination Spanner AF  
1-5/16, 1-3/8, 1-7/16, 1-1/2, 1-5/8, 1-3/4, 1-7/8

Item ID: **6507JAF**

**COMBINATION SPANNER SET 8-19 mm PLASTIC HOLDER 10 PIECES****10**  
PIECES**mm****CONTENTS**

- » Combination Spanner Metric  
8, 10, 11, 12, 13, 14, 15, 16, 17, 19

Item ID: **6510A****COMBINATION SPANNER SET 20-32 mm PLASTIC HOLDER 12 PIECES****12**  
PIECES**mm****CONTENTS**

- » Combination Spanner Metric  
20, 21, 22, 23, 24, 25, 26, 27, 28, 29, 30, 32

Item ID: **6512MMA****COMBINATION SPANNER SET 5.5-19 mm PLASTIC HOLDER 15 PIECES****15**  
PIECES**mm****CONTENTS**

- » Combination Spanner Metric  
6, 7, 8, 9, 10, 11, 12, 13, 14, 15, 16, 17, 18, 19, 5.5

Item ID: **6515MMA****COMBINATION SPANNER SET 33-50 mm PLASTIC HOLDER 7 PIECES****7**  
PIECES**mm****CONTENTS**

- » Combination Spanner Metric  
33, 34, 36, 38, 41, 46, 50

Item ID: **6507JMMA**



### COMBINATION SPANNER ANTI SLIP METRIC



ITEM ID:	SIZE	LENGTH (mm)	JAW DIAMETER (mm)	JAW HEIGHT (mm)	RING DIAMETER (mm)	RING HEIGHT (mm)
800608	8	120	18.9	4.5	12.8	6.6
800609	9	130	20.8	4.5	14.2	7
800610	10	140	22.5	5	15.6	7.7
800611	11	150	24.5	5.4	16.9	8.4
800612	12	160	27.2	5.5	18	8.5
800613	13	170	29.6	5.9	19.5	8.8
800614	14	180	31.1	6.2	21.5	9.6
800615	15	185	32.5	6.4	22.8	10.1
800616	16	195	35	6.5	24.2	10.5
800617	17	202	37	6.9	25.2	11
800618	18	208	39	7.1	26.8	11.5
800619	19	218	41.1	7.5	28.4	12.2



TengTools **Anti Slip** spanner design grips onto the surface of the nut or bolt, providing better traction and reducing the risk of the spanner slipping off the fastener.

**Slipping or losing control of a spanner can cause injury or damage to the surrounding equipment.**

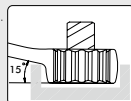
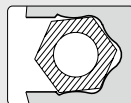

### COMBINATION SPANNER SET ANTI SLIP TOOL ROLL 12 PIECES



#### CONTENTS

- » Combination Spanner Anti Slip Metric 8, 9, 10, 11, 12, 13, 14, 15, 16, 17, 18, 19

Item ID: **8512MM**



### COMBINATION SPANNER SET ANTI SLIP PLASTIC HOLDER 12 PIECES



#### CONTENTS

- » Combination Spanner Anti Slip Metric 8, 9, 10, 11, 12, 13, 14, 15, 16, 17, 18, 19

Item ID: **8512A**



**STUBBY COMBINATION SPANNER METRIC**



ITEM ID:	SIZE	LENGTH (mm)	JAW DIAMETER (mm)	JAW HEIGHT (mm)	RING DIAMETER (mm)	RING HEIGHT (mm)
6005M10	10	95	21.9	5.1	16.2	7
6005M11	11	100	23.8	5.9	17.9	7.8
6005M12	12	105	24.7	6.6	19.1	8.2
6005M13	13	110	27.1	6.7	19.3	8.8
6005M14	14	115	28.9	7.4	21.8	9.1
6005M15	15	120	31.1	7.5	22.6	9.2
6005M16	16	125	33	8.1	23.6	9.8
6005M17	17	130	36	8.3	25.9	10.3
6005M18	18	135	36.8	8.7	27.2	11
6005M19	19	140	38.1	9.4	28.7	11.2



**LONG COMBINATION SPANNER METRIC**



ITEM ID:	SIZE	LENGTH (mm)	JAW DIAMETER (mm)	JAW HEIGHT (mm)	RING DIAMETER (mm)	RING HEIGHT (mm)
605908	8	148	17.2	4.9	12.6	5.3
605909	9	158	19.4	5	13.7	6.2
605910	10	168	21.7	5.6	15.2	6.4
605911	11	188	23.1	5.6	16.7	7.3
605912	12	198	25.3	6.3	17.7	7.9
605913	13	208	26.6	6.7	19.8	8.6
605914	14	228	29.8	7.4	21.4	9
605915	15	238	32.4	7.6	22.5	9.9
605916	16	246	32.4	8.2	23.5	10.4
605917	17	266	36	8.2	25.4	40.5
605918	18	276	37.4	9	26.6	12.4
605919	19	285	39.8	9.1	28.3	12.6



**LONG COMBINATION SPANNER SET 8-19 mm  
TOOL ROLL 9 PIECES**



**CONTENTS**

- » Long Combination Spanner Metric  
8, 10, 11, 12, 13, 14, 15, 17, 19

Item ID: **6059LMP**







## Do's and Don't's of Spanners

### DO'S

- **Use the right size spanner** for the job: Make sure you have the correct size spanner for the nut or bolt you are working on.
- **Keep the spanner clean and dry:** Wipe down the spanner after use to prevent rust and corrosion.
- **Apply pressure correctly:** Apply pressure to the spanner in the direction that tightens the nut or bolt.
- **Use the right technique:** Use a firm grip on the spanner and turn it with a smooth motion. Avoid jerking or twisting the spanner, as this can cause damage to both the tool and the fastener.
- **Inspect the spanner regularly:** Check the spanner for any signs of wear or damage. Replace any damaged tools immediately.

### DONT'S

- **Use a damaged spanner:** Do not use a spanner that is damaged or worn, as it may slip or break during use.
- **Use a spanner as a hammer:** Do not use a spanner as a hammer or pry bar, as this can damage both the spanner and the object you are working on.
- **Over-tighten nuts and bolts:** Do not over-tighten nuts and bolts with a spanner, as this can cause damage to the fastener and the tool.
- **Use a spanner in wet or oily conditions:** Do not use a spanner in wet or oily conditions, as this can cause the tool to slip and cause injury.



### RATCHETING COMBINATION SPANNER METRIC R



ITEM ID:	SIZE	NO. OF TEETH	REVERSE	LENGTH (mm)	JAW DIAMETER (mm)	JAW HEIGHT (mm)	RING DIAMETER (mm)	RING HEIGHT (mm)
600508R	8	72	Flip reverse lever	140	17	4	17	6.5
600509R	9	72	Flip reverse lever	150	19	4.4	18.5	6.9
600510R	10	72	Flip reverse lever	159	21	4.8	20	7.3
600511R	11	72	Flip reverse lever	165	23	5.2	22	7.7
600512R	12	72	Flip reverse lever	172	25	5.5	23	8.2
600513R	13	72	Flip reverse lever	178	27	5.8	25	8.5
600514R	14	72	Flip reverse lever	191	29	6.2	27	9
600515R	15	72	Flip reverse lever	200	31	6.5	28	9.4
600516R	16	72	Flip reverse lever	208	33	6.8	30	9.9
600517R	17	72	Flip reverse lever	226	36	7.2	32	10.3
600518R	18	72	Flip reverse lever	237	38	7.7	33	10.7
600519R	19	72	Flip reverse lever	248	40	8.2	34	11.2
600522R	22	72	Flip reverse lever	290	45	9	38.4	13
600524R	24	72	Flip reverse lever	323	52	9.8	43.6	14.5
600527R	27	72	Flip reverse lever	359	56	10.5	52.5	15.5
600530R	30	72	Flip reverse lever	403	59	11.4	58.5	17
600532R	32	72	Flip reverse lever	425	63	12.5	62.5	17.5



**RATCHETING COMBINATION SPANNER AF R**



ITEM ID:	SIZE	NO. OF TEETH	REVERSE	LENGTH (mm)	JAW DIAMETER (mm)	JAW HEIGHT (mm)	RING DIAMETER (mm)	RING HEIGHT (mm)
600110R	5/16	72	Flip reverse lever	140	16.7	4.6	16.6	6.5
600112R	3/8	72	Flip reverse lever	159	20.8	5.3	20	7.3
600114R	7/16	72	Flip reverse lever	165	23	5.6	21.8	7.7
600116R	1/2	72	Flip reverse lever	178	27.1	6.4	24.7	8.6
600118R	9/16	72	Flip reverse lever	191	29.2	6.8	27	9
600120R	5/8	72	Flip reverse lever	208	33.4	7.2	30	9.9
600122R	11/16	72	Flip reverse lever	226	35.5	7.7	31.8	10.3
600124R	3/4	72	Flip reverse lever	248	39.7	8.8	33.8	11.2
600126R	13/16	72	Flip reverse lever	290	46	9	40	13
600128R	7/8	72	Flip reverse lever	290	46	9	40	13



**RATCHETING COMBINATION SPANNER SET R TOOL ROLL 8 PIECES**



**CONTENTS**

- » Ratcheting Combination Spanner Metric R 8, 10, 11, 12, 13, 14, 17, 19

Item ID: **6508RMM**



**RATCHETING COMBINATION SPANNER SET R TOOL ROLL 10 PIECES**



**CONTENTS**

- » Ratcheting Combination Spanner Metric R 10, 11, 12, 13, 14, 15, 16, 17, 18, 19

Item ID: **6510RMM**





### RATCHETING COMBINATION SPANNER METRIC RS



CrV  
STEEL

ITEM ID:	SIZE	NO. OF TEETH	REVERSE	LENGTH (mm)	JAW DIAMETER (mm)	JAW HEIGHT (mm)	RING DIAMETER (mm)	RING HEIGHT (mm)
600508RS	8	72	Turn over	111	19.6	4	17	6.8
600509RS	9	72	Turn over	123	20.8	4.4	19	7.2
600510RS	10	72	Turn over	131	22	4.8	20	7.6
600511RS	11	72	Turn over	147	24.2	5.2	21	8
600512RS	12	72	Turn over	155	25.7	5.5	23	8.5
600513RS	13	72	Turn over	164	27.2	5.8	25	8.9
600514RS	14	72	Turn over	182	30.8	6.2	27	9.3
600515RS	15	72	Turn over	192	32.4	6.5	28	9.7
600516RS	16	72	Turn over	202	34	6.8	30	10.2
600517RS	17	72	Turn over	223	37.7	7.2	32	10.6
600518RS	18	72	Turn over	234	39.3	7.7	33	11
600519RS	19	72	Turn over	246	40.8	8.2	34	11.5
600520RS	20	72	Turn over	285	46	10	42	13
600521RS	21	72	Turn over	285	46	10	42	13
600522RS	22	72	Turn over	285	46	10	42	13
600524RS	24	72	Turn over	325	51.5	11	47.5	14.5



### RATCHETING COMBINATION SPANNER SET RS TOOL ROLL 8 PIECES



mm

#### CONTENTS

- » Ratcheting Combination Spanner Metric RS  
8, 10, 11, 12, 13, 14, 17, 19

Item ID: **6508RSMM**



### RATCHETING COMBINATION SPANNER SET RS TOOL ROLL 12 PIECES



mm

#### CONTENTS

- » Ratcheting Combination Spanner Metric RS  
8, 9, 10, 11, 12, 13, 14, 15, 16, 17, 18, 19

Item ID: **6512RSMM**



**RATCHETING COMBINATION SPANNER METRIC RF**



ITEM ID:	NO. OF SIZE	TEETH	REVERSE	LENGTH (mm)	JAW DIAMETER (mm)	JAW HEIGHT (mm)	RING DIAMETER (mm)	RING HEIGHT (mm)
600507RF	7	72	Turn over	127	17.6	4	17	6.8
600508RF	8	72	Turn over	127	17.6	4	17	6.8
600509RF	9	72	Turn over	131	19.8	4.4	19	7.2
600510RF	10	72	Turn over	136	22	4.8	20	7.6
600511RF	11	72	Turn over	141	24.1	5.2	21	8
600512RF	12	72	Turn over	147	25.9	5.5	23	8.5
600513RF	13	72	Turn over	154	27.3	5.8	25	9
600514RF	14	72	Turn over	160	30.6	6.2	27	9.3
600515RF	15	72	Turn over	169	32.2	6.5	28	9.7
600516RF	16	72	Turn over	179	33.7	6.8	30	10.2
600517RF	17	72	Turn over	190	36.6	7.2	32	10.6
600518RF	18	72	Turn over	203	38.4	7.7	33	11
600519RF	19	72	Turn over	215	40.2	8.2	34	11.5



**STUBBY RATCHETING COMBINATION SPANNER METRIC RS**



ITEM ID:	NO. OF SIZE	TEETH	REVERSE	LENGTH (mm)	JAW DIAMETER (mm)	JAW HEIGHT (mm)	RING DIAMETER (mm)	RING HEIGHT (mm)
6005M10RS	10	72	Turn over	97	22	4.8	20	7.6
6005M11RS	11	72	Turn over	102	24.2	5.2	21	8
6005M12RS	12	72	Turn over	106	25.7	5.5	23	8.5
6005M13RS	13	72	Turn over	110	27.2	5.8	25	8.9
6005M14RS	14	72	Turn over	115	30.8	6.2	27	9.3
6005M15RS	15	72	Turn over	119	32.4	6.5	28	9.7
6005M16RS	16	72	Turn over	123	34	6.8	30	10.2
6005M17RS	17	72	Turn over	127	37.7	7.2	32	10.6
6005M18RS	18	72	Turn over	132	39.3	7.7	33	11
6005M19RS	19	72	Turn over	139	40.8	8.2	34	11.5





## DOUBLE RING SPANNER METRIC



ITEM ID:	SIZE	LENGTH (mm)	RING DIAMETER (mm)	RING HEIGHT (mm)
630607	6 x 7	168	10,7;12,2	5,6;6,3
630809	8 x 9	183	13,6;15,1	6,6;7
631011	10 x 11	198	16,6;18	7,4;7,7
631213	12 x 13	217	19,5;20,9	8,1;8,4
631415	14 x 15	239	22,4;23,7	8,8;9,1
631617	16 x 17	260	25,3;26,7	9,5;9,8
631819	18 x 19	292	28,2;29,7	10,1;10,4
632022	20 x 22	318	31,1;34	10,9;11,4
632123	21 x 23	326,5	32,6;35,5	11,2;11,6
632427	24 x 27	329	36,9;41	12,4;13,4
633032	30 x 32	362	45,5;48,5	14,4;15,2



## DOUBLE RING SPANNER AF



ITEM ID:	SIZE	LENGTH (mm)	RING DIAMETER (mm)	RING HEIGHT (mm)
673032	1/4 x 5/16	168	10,7;12,2	5,6;6,3
673436	3/8 x 7/16	198	16,6;18	7,4;7,7
673840	1/2 x 7/16	217	19,5;20,9	8,1;7,7
674244	13/16 x 7/8	318	31,1;34	10,9;11,4
674648	15/16 x 1-1/16	347	36,9;40,5	12,4;13,4
675052	1 x 1-1/8	355	38,4;42,8	12,7;13,7
675456	1-1/8 x 1-1/4	362	45,5;48,5	14,4;15,2





**LONG DOUBLE RING SPANNER METRIC**



ITEM ID:	SIZE	LENGTH (mm)	RING DIAMETER (mm)	RING HEIGHT (mm)
630810FL	8 x 10	265	12,5;15	7,5;8,4
631113FL	11 x 13	328	17,8;20,3	10,4;11,3
631214FL	12 x 14	328	17,8;20,3	10,4;11,3
631618FL	16 x 18	408	23,4;26,3	12,8;14,4
631719FL	17 x 19	407	23,7;26,6	13;14,8
632224FL	22 x 24	430	31,3;34	15,4;17,7



**DOUBLE RING SPANNER RIGGER JIGGER 10 X 13mm**



ITEM ID:	SIZE	LENGTH (mm)	RING DIAMETER (mm)	RING HEIGHT (mm)
601013	10 x 13	115.8	15,5;17,9	8;8



**DOUBLE RING SPANNER SET 8 PIECES**



**CONTENTS**

- » Double Ring Spanner Metric  
6 x 7, 8 x 9, 10 x 11, 12 x 13, 14 x 15, 16 x 17, 18 x 19, 20 x 22

Item ID: **6308**



**DOUBLE RING SPANNER SET 11 PIECES**



**CONTENTS**

- » Double Ring Spanner Metric  
6 x 7, 8 x 9, 10 x 11, 12 x 13, 14 x 15, 16 x 17, 18 x 19, 20 x 22, 21 x 23, 24 x 27, 30 x 32

Item ID: **6311**







### DOUBLE RING SPANNER SET TOOL ROLL 8 PIECES

8  
PIECES

mm

#### CONTENTS

- » Double Ring Spanner Metric  
6 x 7, 8 x 9, 10 x 11, 12 x 13, 14 x 15, 16 x 17, 18 x 19, 20 x 22

Item ID: **6308MM**



### DOUBLE RING SPANNER SET AF TOOL ROLL 7 PIECES

7  
PIECES

AF

#### CONTENTS

- » Double Ring Spanner AF  
1/4 x 5/16, 3/8 x 7/16, 1/2 x 7/16, 13/16 x 7/8, 15/16 x 1-1/16, 1 x 1-1/8, 1-1/8 x 1-1/4

Item ID: **6707AF**



### SPANNER RING

ITEM ID:	LENGTH (mm)
600	110



### DOUBLE OPEN ENDED SPANNER METRIC

mm

CrV  
STEEL

ITEM ID:	SIZE	LENGTH (mm)	JAW DIAMETER (mm)	JAW HEIGHT (mm)
620607	6 x 7	123	15,5;18	3,7;3,7
620809	8 x 9	140	20,4;22,7	4;4
621011	10 x 11	156	24,9;27,1	5;5
621213	12 x 13	172	29,2;31,2	5,5;5,5
621415	14 x 15	188,5	33,3;35,3	5,9;5,9
621617	16 x 17	204	37,1;38,9	6,3;6,3
621819	18 x 19	221	40,9;42,8	6,7;9,7
622022	20 x 22	237	44,8;48,8	7,1;7,1
622123	21 x 23	247	46,8;50,8	7,7;7,7
622427	24 x 27	263	52,8;59,1	8,1;8,1
623032	30 x 32	298	65,4;69,8	9;9





**DOUBLE OPEN ENDED SPANNER AF**

**AF** **CrV STEEL**

ITEM ID:	SIZE	LENGTH (mm)	JAW DIAMETER (mm)	JAW HEIGHT (mm)
663032	1/4 x 5/16	123	15,5;18	2,9;2,9
663436	3/8 x 7/16	156	24,9;27,1	3,4;3,4
663840	1/2 x 9/16	180	31,3;33,3	4,4
664244	5/8 x 3/4	221	37,1;42,8	4,6;4,6
664648	13/16 x 7/8	237	44,8;48,8	4,9;4,9
665052	15/16 x 1	255	50,8;56,8	5,3;5,3
665456	1-1/8 x 1-1/4	298	65,4;69,8	6,6



**DOUBLE OPEN ENDED SPANNER SET 8 PIECES**

**8** **mm**

**CONTENTS**  
 » Double Open Ended Spanner Metric  
 6 x 7, 8 x 9, 10 x 11, 12 x 13, 14 x 15, 16 x 17, 18 x 19, 20 x 22

Item ID: **6208**



**DOUBLE OPEN ENDED SPANNER SET 11 PIECES**

**11** **mm**

**CONTENTS**  
 » Double Open Ended Spanner Metric  
 6 x 7, 8 x 9, 10 x 11, 12 x 13, 14 x 15, 16 x 17, 18 x 19, 20 x 22, 21 x 23, 24 x 27, 30 x 32

Item ID: **6211**



**DOUBLE OPEN ENDED SPANNER SET TOOL ROLL 11 PIECES**

**11** **mm**

**CONTENTS**  
 » Double Open Ended Spanner Metric  
 6 x 7, 8 x 9, 10 x 11, 12 x 13, 14 x 15, 16 x 17, 18 x 19, 20 x 22, 21 x 23, 24 x 27, 30 x 32

Item ID: **6211MM**





### DOUBLE OPEN ENDED SPANNER SET AF TOOL ROLL 7 PIECES

7  
PIECES

AF

#### CONTENTS

- » Double Open Ended Spanner AF  
1/4 x 5/16, 3/8 x 7/16, 1/2 x 9/16, 5/8 x 3/4, 13/16 x 7/8, 15/16 x 1, 1-1/8 x 1-1/4

Item ID: **6607AF**



### DOUBLE FLEX WRENCH METRIC

mm

CrV  
STEEL

ITEM ID:	SIZE	LENGTH (mm)
650809	8 x 9	192
651011	10 x 11	200
651013	10 x 13	213
651213	12 x 13	218
651415	14 x 15	243
651617	16 x 17	275
651819	18 x 19	284



### DOUBLE FLEX WRENCH AF

AF

CrV  
STEEL

ITEM ID:	SIZE	LENGTH (mm)
611214	3/8 x 7/16	200
611618	1/2 x 9/16	218
612022	5/8 x 11/16	275



### BI-FLEX WRENCH

CrV  
STEEL

ITEM ID:	SIZE	LENGTH (mm)
691406	1/4 x 1/4	196



**FLARE NUT WRENCH METRIC**



ITEM ID:	SIZE	JAW DIAMETER (mm)	JAW HEIGHT (mm)	JAW OPENING (mm)
641011	10 x 11	21,4;23	7,9;7,9	7;8,2
641213	12 x 13	25;27,4	10;10	9;10,3
641314	13 x 14	25;27,4	13,1;13,1	14,3;15,1
641617	16 x 17	29,9;31,9	15,1;15,1	15,4;17
641922	19 x 22	34,2;38,2	17;17	18,9;20



**FLARE NUT WRENCH AF**



ITEM ID:	SIZE	JAW DIAMETER (mm)	JAW HEIGHT (mm)	JAW OPENING (mm)
661416	7/16 x 1/2	23;24,3	11,9;11,9	8,2;9



**RATCHETING MULTI DRIVE RING SPANNER**



ITEM ID:	SIZE	NO. OF TEETH	REVERSE	LENGTH (mm)	RING DIAMETER (mm)
60050811RX	8 x 9;10 x 11	72	Flip reverse lever	150	19,2;22
60051215RX	12 x 13;14 x 15	72	Flip reverse lever	190	25,5;28
60051619RX	16 x 17;18 x 19	72	Flip reverse lever	320	31,7;34



**RATCHETING MULTI DRIVE RING SPANNER SET 3 PIECES**



**CONTENTS**

- » Ratcheting Multi Drive Ring Spanner  
8 x 9;10 x 11, 12 x 13;14 x 15, 16 x 17;18 x 19

Item ID: **6503RX**





### RATCHETING OFFSET RING SPANNER METRIC

CrV  
STEEL

ITEM ID:	SIZE	NO. OF TEETH	REVERSE	LENGTH (mm)	RING DIAMETER (mm)	RING HEIGHT (mm)
680608	6 x 8	18	Flip reverse lever	112	20;20	8;8
680709	7 x 9	18	Flip reverse lever	133	21;23	8,4;8,4
681013	10 x 13	18	Flip reverse lever	163	26;30	10,2;10,2
681214	12 x 14	18	Flip reverse lever	172	30;32	10,2;10,2
681719	17 x 19	18	Flip reverse lever	203	37;40	11;11
682122	21 x 22	18	Flip reverse lever	235	41;45	11,4;11,4



### RATCHETING OFFSET TX-E RING SPANNER

CrV  
STEEL

ITEM ID:	SIZE	NO. OF TEETH	REVERSE	LENGTH (mm)	RING DIAMETER (mm)	RING HEIGHT (mm)
680810E	E8 x E10	18	Flip reverse lever	133	21;23	8,2;8,2
681112E	E11 x E12	18	Flip reverse lever	140	26;30	8,2;8,2
681416E	E14 x E16	18	Flip reverse lever	172	30;32	10,2;10,2
681820E	E18 x E20	18	Flip reverse lever	103	37;40	11,5;11,5
682224E	E22 x E24	18	Flip reverse lever	235	41;44	11,5;11,5



### RATCHETING CONSTRUCTION WRENCH

ITEM ID:	SIZE	NO. OF TEETH	REVERSE	LENGTH (mm)	WIDTH (mm)	HEIGHT (mm)
PGW1719	17 x 19	32	Flip reverse lever	315	42	50
PGW1922	19 x 22	32	Flip reverse lever	315	42	50
PGW1924	19 x 24	32	Flip reverse lever	450	63	63
PGW2124	21 x 24	32	Flip reverse lever	315	42	50
PGW2430	24 x 30	32	Flip reverse lever	366	65	63
PGW2730	27 x 30	32	Flip reverse lever	315	42	50





**QUICK WRENCH**

ITEM ID:	SIZE	LENGTH (mm)	RING DIAMETER (mm)	RING HEIGHT (mm)	HEIGHT (mm)
600813	13	141	27.5	7.2	8
600814	14	191	35.7	10	9
600816	16	191	35.7	10	9
600817	17	191	35.7	10	9
600819	19	191	35.7	10	9
600822	22	233	40.7	13	12
600824	24	235	43.2	13	12
600827	27	325	54.2	14.1	14.4
600830	30	325	56.4	15.9	14.4
600832	32	325	58.5	15.9	14.4



**HOOK WRENCH**



ITEM ID:	CAPACITY	CAPACITY	LENGTH (mm)
HP101	3/4"-1-1/4"	19-50	145
HP102	1-1/4"-3"	32-75	178
HP103	2"-4-3/4"	50-120	247



**PIN WRENCH**



ITEM ID:	SIZE	CAPACITY	LENGTH (mm)
HP2014	4	19-50	145
HP2015	5	19-50	145
HP2025	5	32-75	178
HP2026	6	32-75	178
HP2036	6	50-120	247
HP2038	8	50-120	247



**TELESCOPIC BASIN TAP WRENCH**

ITEM ID:	CAPACITY	LENGTH (mm)
BWT406	32-48	275





**RING END SLOGGING WRENCH METRIC****CrMo**  
STEEL

ITEM ID:	SIZE	LENGTH (mm)	RING DIAMETER (mm)	RING HEIGHT (mm)	HEIGHT (mm)
903024	24	162	42.8	14.7	7.9
903027	27	180	45.5	17	8.6
903030	30	190	52.5	17.5	10
903032	32	190	52.5	17.5	10
903036	36	205	58.3	20	11
903038	38	229	63.9	20	12
903041	41	230	63.7	20	11.7
903046	46	240	73	23	13
903050	50	255	87.5	25	13
903055	55	266	78.5	25	13
903060	60	280	91.3	26.4	17
903065	65	297	100.3	27	16.4
903070	70	328	109.5	34.5	18
903075	75	328	109.5	34.5	18
903080	80	340	129.3	37	23.6
903085	85	340	129.3	37	23.6
903090	90	390	144	38.8	21.8
903095	95	390	144	38.8	21.8
903100	100	420	154	42.4	23.5

**OPEN END SLOGGING WRENCH METRIC****CrMo**  
STEEL

ITEM ID:	SIZE	LENGTH (mm)	JAW DIAMETER (mm)	JAW HEIGHT (mm)	HEIGHT (mm)
902024	24	170	47.2	15.5	9.2
902027	27	180	53.5	17.3	8.6
902030	30	190	60.2	18.4	10.6
902032	32	190	60.2	18.4	10.6
902036	36	215	72.3	18.9	10.5
902038	38	215	72.3	18.9	10.5
902041	41	235	83.4	22	15.2
902046	46	255	94	21	12.1
902050	50	299	113	27.1	16
902055	55	299	113	27.1	16
902060	60	338	134.8	32.7	18.9
902065	65	338	134.8	32.7	18.9
902070	70	367	148.9	36	22
902075	75	367	148.9	36	22
902080	80	400	175	33	19
902085	85	400	175	33	19
902090	90	450	197	38	22
902095	95	450	197	38	22
902100	100	485	215	46	26.5

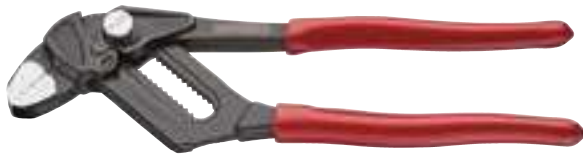

**QUICK SET PLIERS WRENCH**

ITEM ID:	CAPACITY	LENGTH (mm)	JAW DEPTH (mm)
MB483-7	37	180	25
MB483-10	45	250	35

**ALUMINIUM PIPE WRENCH**

ITEM ID:	CAPACITY	CAPACITY	LENGTH (mm)
PWC12	1-11/16	43	300
PWC14	1-31/32	50	350
PWC18	2-23/64	60	450
PWC24	3	76	600
PWC36	4-1/64	102	900





### ADJUSTABLE WRENCH

ITEM ID:	CAPACITY	CAPACITY	LENGTH (mm)	JAW DIAMETER (mm)	JAW DEPTH (mm)
4001	11/16	17	100	31	14
4002	15/16	24	150	44	19
4003	1-1/8	28	200	57	26
4004	1-1/4	33	250	68	31
4005	1-1/2	38	300	80	32
4006	1-5/16	50	375	100	44
4007	2-3/8	60	450	122	53
4008	2-3/4	80	600	144	62



### ADJUSTABLE WRENCH TPR GRIP

**TPR**  
GRIP

ITEM ID:	CAPACITY	CAPACITY	LENGTH (mm)	JAW DIAMETER (mm)	JAW DEPTH (mm)
4002IQ	15/16	24	157	52	20
4003IQ	1-1/8	28	206	62	25.3
4004IQ	1-1/4	33	255	72	29.5
4005IQ	1-1/2	38	305	83	32.2
4006IQ	1-15/16	50	380	108	44.7





### ADJUSTABLE WRENCH WIDE JAW

ITEM ID:	CAPACITY	CAPACITY	LENGTH (mm)	JAW DIAMETER (mm)	JAW DEPTH (mm)
4002WT	1-3/8	34	172	63.5	30
4003WT	1-1/2	38	221	72.1	34.1
4004WT	2	50	275	92.1	41
4005WT	2-3/8	60	317	110.5	55.7



### ADJUSTABLE WRENCH ALLIGATOR

ITEM ID:	CAPACITY	CAPACITY	LENGTH (mm)	JAW DIAMETER (mm)	JAW DEPTH (mm)
4003J	1-1/4	33	200	68	29





# SCREWDRIVERS

## MORE COMFORT MORE POWER

Unlike other brands the TengTools screwdriver blade has steel alloy wings that the plastic handle is moulded around. This allows for greater torque to be put on the screwdriver, ensures the blade is dead straight and stops the blade from moving in the handle.

Size and tip marked at the bottom of each handle for easy identification

Hole in the handle can be used in a fall arrest system, for storage and for use as a T-handle

The bi-material handle is designed for increased comfort and smooth action preventing blisters after continuous use. It gives better support and increased power transfer.

The soft black material prevents the screwdriver from sticking in the hand allowing for rapid movement

The red resistant plastic is used for the core and ensures the blade is held securely

Size marked on shaft for identification while in use

Shaft made from TengTools TT-MV PLUS steel alloy for greater strength and material flexibility

Magnetic tip designed to maximise torque transfer and reduce wear

Designed and manufactured to DIN and ISO industrial standards





- 
- 
- 
- 
- 
- 
- 
- 
- 
- 
- 
- 
- 
- 
- 
- 
- 
- 
- 
- 
- 





### FLAT MINI SCREWDRIVER



ITEM ID:	Tip Size	Shaft	Length	Shaft Length	Weight g
MDM713	2	●	122	40	20
MDM714	2.4	●	122	40	20
MDM715	3	●	122	40	20



### PH MINI SCREWDRIVER



ITEM ID:	Tip Size	Shaft	Length	Shaft Length	Weight g
MDM716	PH00	●	122	40	20
MDM717	PH0	●	122	40	20
MDM718	PH1	●	122	40	24



### TX MINI SCREWDRIVER



ITEM ID:	Tip Size	Shaft	Length	Shaft Length	Weight g
MDM806	TX6	●	122	40	12
MDM807	TX7	●	122	40	12
MDM808	TX8	●	122	40	12
MDM809	TX9	●	122	40	13
MDM810	TX10	●	122	40	13
MDM815	TX15	●	122	40	16



### HEX MINI SCREWDRIVER



ITEM ID:	Tip Size	Shaft	Length	Shaft Length	Weight g
MDM711	2	●	122	40	24
MDM712	2.5	●	122	40	24





### SCREWDRIVER SET 6 PIECE MINI FLAT, PH



#### CONTENTS

- » Flat Mini Screwdriver  
2, 2.4, 3
- » PH Mini Screwdriver  
PH00, PH0, PH1

Item ID: **MDM706**



### MINI T HANDLE TX KEY SET



#### CONTENTS

- » Mini TX Key  
TX6, TX7, TX8, TX9, TX10, TX15

Item ID: **MDM706TXT**



### MINI SCREWDRIVER HANDLE & DOUBLE ENDED MINI SCREWDRIVER BLADES

ITEM ID:	Tip Size	Shaft	Length	Weight g
MDM700		Hex	112	26
2912512	Flat 2-PH00	Hex	120	11
2912513	Flat 3-PH0	Hex	120	11
2912514	Flat 4-PH1	Hex	120	11
2912520	PZ0-PZ1	Hex	120	11
2912535	TX5-TX7	Hex	120	11
2912537	TX6-TX8	Hex	120	11
2912539	TX9-TX10	Hex	120	11



### MINI SCREWDRIVER SET 8 PIECES



#### CONTENTS

- » Double Ended Mini Screwdriver Blade  
Flat 2-PH00, Flat 3-PH0, Flat 4-PH1, PZ0-PZ1,  
TX5-TX7, TX6-TX8, TX9-TX10
- » Mini Screwdriver Handle

Item ID: **TM708**





**MINI TX KEY**



ITEM ID:	Tip Size	Shaft	Length	Shaft Length	Weight g
MDM806T	TX6	●	95	50	9
MDM807T	TX7	●	95	50	10
MDM808T	TX8	●	95	50	9
MDM809T	TX9	●	95	50	13
MDM810T	TX10	●	95	50	13
MDM815T	TX15	●	95	50	13



**SCREWDRIVER SET 6 PIECE MINI TX**



**CONTENTS**

- » TX Mini Screwdriver
- » TX6, TX7, TX8, TX9, TX10, TX15

Item ID: **MDM706TX**



**CHOOSE THE RIGHT HANDLE FOR THE RIGHT TASK**

A larger type of handle allows for more power and force to be executed with the driver while a smaller type of handle make it easier to work quickly as less force is required with the driver.

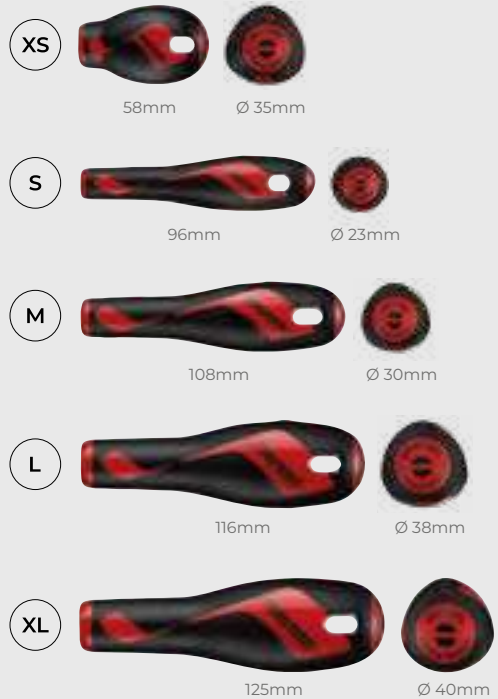

**SCREWDRIVER PHI X 120mm MINI**

- TT-MV PLUS steel alloy for greater strength and material flexibility
- Ergonomically designed bi-material handle for easy use with higher torque and faster speed
- Pocket clip
- Hole in the handle for hanging or for use with a fall protection wire if needed
- The handle is moulded around the blade to ensure straightness and to allow larger blade wings which give a higher torque capacity
- DIN ISO 8764

Item ID: **MDMC715N****FLAT SCREWDRIVER**

ITEM ID:	Tip Size	Shaft	Length	Shaft Length	Weight g	Handle
MD914N	0.4 x 2.5	●	146	50	25	S
MD915N	0.5 x 2.5	●	171	75	26	S
MD915N1	0.5 x 2.5	●	296	200	30	S
MD920N	0.5 x 3.0	●	171	75	26	S
MD920N1	0.5 x 3.0	●	196	100	29	S
MD916N	0.6 x 3.5	●	171	75	30	S
MD916N1	0.6 x 3.5	●	196	100	32	S
MD916N2	0.6 x 3.5	●	246	150	35	S
MD917N	0.8 x 4.0	●	196	100	36	S
MD917N1	0.8 x 4.0	●	496	400	63	S
MD917N2	0.8 x 4.0	●	246	150	40	S
MD922N	1.0 x 5.5	●	246	75	57	S
MD923N	1.0 x 5.5	●	258	150	69	M
MD923N1	1.0 x 5.5	●	308	200	75	M
MD928N	1.2 x 6.5	●	96	38	47	XS
MD928N1	1.2 x 6.5	●	216	100	98	L
MD928N2	1.2 x 6.5	●	266	150	108	L
MD928N3	1.2 x 6.5	●	316	200	117	L
MD928N4	1.2 x 6.5	●	208	100	77	M
MD928N5	1.2 x 6.5	●	258	150	89	M
MD928N6	1.2 x 6.5	●	308	200	100	M
MD928N7	1.2 x 6.5	●	508	400	152	M
MD930N	1.6 x 10.0	●	325	200	231	XL
MD931N	1.0 x 5.5	●	241	125	65	L
MD932N	1.2 x 6.5	●	216	100	105	L
MD932N1	1.2 x 6.5	●	266	150	117	L
MD934N	1.2 x 8.0	●	275	150	159	XL
MD935N	1.6 x 10.0	●	325	200	231	XL





## PH SCREWDRIVER



ITEM ID:	Tip Size	Shaft	Length	Shaft Length	Weight g	Handle
MD940N	PH0	●	171	75	28	S
MD940N1	PH0	●	396	300	40	S
MD947N	PH1	●	96	38	40	XS
MD947N1	PH1	●	183	75	55	M
MD948N	PH2	●	96	38	47	XS
MD948N1	PH2	●	216	100	98	L
MD948N2	PH2	●	316	200	120	L
MD948N3	PH2	●	516	400	161	L
MD948N4	PH2	●	208	100	71	M
MD948N5	PH2	●	308	200	92	M
MD948N6	PH2	●	508	400	135	M
MD948N8	PH2	●	408	300	115	M
MD952N	PH2	●	216	100	101	L
MD952N1	PH2	●	516	400	181	L
MD949N	PH3	●	275	150	155	XL
MD953N	PH3	●	275	150	160	XL
MD950N	PH4	●	325	200	234	XL
MD954N	PH4	●	325	200	233	XL

## PZ SCREWDRIVER



ITEM ID:	Tip Size	Shaft	Length	Shaft Length	Weight g	Handle
MD960N	PZ0	●	171	75	28	S
MD961N	PZ1	●	183	75	29	M
MD961N1	PZ1	●	358	250	75	M
MD961N2	PZ1	●	96	38	41	XS
MD962N	PZ2	●	216	100	100	L
MD962N1	PZ2	●	266	150	109	L
MD962N2	PZ2	●	216	100	105	L
MD962N3	PZ2	●	96	38	47	XS
MD962N4	PZ2	●	208	100	71	M
MD962N5	PZ2	●	258	150	82	M
MD962N4A	PZ2	●	308	200	93	M
MD962N4C	PZ2	●	408	300	114	M
MD962N4D	PZ2	●	508	400	136	M
MD963N	PZ3	●	275	150	161	XL
MD964N	PZ4	●	325	200	233	XL



## Do's and Dont's of Screwdrivers

## DO'S

- Use the right tip
- Keep it clean & dry
- Apply extra torque correctly
- Choose the right handle

## DONT'S

- Do not use the wrong tip
- Do not use the screwdriver as a lever
- Do not use on live electrics
- Do not use too much power

**TX SCREWDRIVER**

ITEM ID:	Tip Size	Shaft	Length	Shaft Length	Weight g	Handle
MD906TN	TX6	●	171	75	32	S
MD907TN	TX7	●	171	75	33	S
MD908TN	TX8	●	171	75	33	S
MD909TN	TX9	●	171	75	33	S
MD910TN	TX10	●	208	100	61	M
MD915TN	TX15	●	208	100	61	M
MD920TN	TX20	●	208	100	61	M
MD925TN	TX25	●	216	100	98	L
MD927TN	TX27	●	216	100	100	L
MD930TN	TX30	●	216	100	99	L
MD940TN	TX40	●	216	100	110	L
MD945TN	TX45	●	237	125	145	XL

**TPX SCREWDRIVER**

ITEM ID:	Tip Size	Shaft	Length	Shaft Length	Weight g	Handle
MD610TPN	TPX10	●	208	100	61	M
MD615TPN	TPX15	●	208	100	61	M
MD620TPN	TPX20	●	208	100	61	M
MD625TPN	TPX25	●	216	100	97	L
MD627TPN	TPX27	●	216	100	96	L
MD630TPN	TPX30	●	216	100	99	L
MD640TPN	TPX40	●	216	100	108	L

**HEX SCREWDRIVER**

ITEM ID:	Tip Size	Shaft	Length	Shaft Length	Weight g	Handle
MD7020HN	2	●	196	100	27	S
MD7030HN	3	●	196	100	31	S







### BALL POINT HEX SCREWDRIVER



ITEM ID:	Tip Size	Shaft	Length	Shaft Length	Weight g	Handle
MD7020HBN	2	●	196	100	26	S
MD7025HBN	2.5	●	196	100	29	S
MD7030HBN	3	●	246	150	36	S
MD7040HBN	4	●	258	150	68	M
MD7050HBN	5	●	266	150	108	L
MD7060HBN	6	●	266	150	123	L
MD7080HBN	8	●	275	150	192	XL



### ROB SCREWDRIVER



ITEM ID:	Tip Size	Shaft	Length	Shaft Length	Weight g	Handle
MD801N	ROB1	●	216	100	98	L
MD802N	ROB2	●	216	100	97	L
MD803N	ROB3	●	216	100	94	L

### DOUBLE ENDED SCREWDRIVER BLADES



ITEM ID:	Tip 1	Size 1	Tip 2	Size 2
MD901	SCREWDRIVER BLADE HANDLE			
PZZ0102	+	PZ1	+	PZ2
PHH0102	+	PH1	+	PH2
FTF4055	-	4	-	5.5
PHF0365	+	PH3	-	6.5
TXX1015	*	TX10	*	TX15
TXX2025	*	TX20	*	TX25
TXX3040	*	TX30	*	TX40
HBH0303	●	3 mm Ball-End	●	3 mm
HBH0404	●	4 mm Ball-End	●	4 mm
HBH0505	●	5 mm Ball-End	●	5 mm
HBH0606	●	6 mm Ball-End	●	6 mm



### FLAT POWER THROUGH SCREWDRIVER



ITEM ID:	Tip Size	Shaft	Length	Shaft Length	Weight g	Handle
MDT932N	1.2 x 6.5		216	100	136	L
MDT934N	1.2 x 8		275	150	215	XL
MDT935N	1.6 x 10		325	200	279	XL



### PH POWER THRU SCREWDRIVER



ITEM ID:	Tip Size	Shaft	Length	Shaft Length	Weight g	Handle
MDT952N	PH2		216	100	136	L
MDT953N	PH3		275	150	218	XL



### NUT DRIVER

ITEM ID:	Size	Length	Shaft Length	Weight g
MDN505	5	237	125	91
MDN5055	5.5	237	125	93
MDN506	6	237	125	93
MDN507	7	237	125	98
MDN508	8	237	125	102
MDN510	10	241	125	130
MDN511	11	241	125	153
MDN512	12	241	125	153
MDN513	13	241	125	160





### T HANDLE NUT DRIVER

ITEM ID:	Size	Length	Shaft Length	Weight g
MDNT405	5	288	230	107
MDNT4055	5.5	288	230	131
MDNT406	6	288	230	130
MDNT407	7	288	230	144
MDNT408	8	288	230	140
MDNT409	9	288	230	143
MDNT410	10	288	230	153
MDNT411	11	288	230	184
MDNT412	12	288	230	187
MDNT413	13	288	230	186
MDNT414	14	288	230	209



### MAGNETIC SCREWDRIVER CHARGER/DISCHARGER

- Magnetic screwdriver charger and discharger
- Use to magnetise or demagnetise screwdrivers
- Supplied on a handy key ring

Item ID: **MR500**



### 53 PIECE SCREWDRIVER SET



#### CONTENTS

- » 1/4" Flat Bits 25 mm  
2, 3, 4, 5, 5.5, 6, 8, 7
- » Flat Screwdriver  
» 0.8 x 4.0, 0.5 x 3.0 (x2) 75 mm and 100 mm, 1.0 x 5.5 (x2) 75 mm and 150 mm, 1.2 x 6.5 (x3) 38 mm, 100 mm and 150 mm, 1.2 x 8.0, 1.6 x 10.0
- » PH Screwdriver  
» PH0, PH1, PH2 (x2) 38 mm and 100 mm, PH3
- » PZ Screwdriver  
» PZ1, PZ2 (x2) 38 mm and 100 mm, PZ3
- » 1/4" Ratcheting Bits Driver Set
- » 1/4" PH Bits 25 mm  
» PH1, PH2
- » 1/4" PZ Bits 25 mm  
» PZ0, PZ1, PZ2
- » 1/4" ROB Bits 25 mm  
» 1, 2, 3
- » 1/4" TPX Bits 25 mm  
» TPX20, TPX25, TPX30
- » 1/4" TX Bits 25 mm  
» TX6, TX7, TX8, TX9, TX10, TX15, TX20, TX25, TX27, TX30, TX40
- » Hex Socket Adaptor 1/4" Hex - 1/4" 25mm

Item ID: **MD9053N**

**10 PIECE SCREWDRIVER SET FLAT, PH, PZ****CONTENTS**

- » Flat Screwdriver
  - » 0.5 x 3.0, 1.0 x 5.5 (x2) 75 mm and 150 mm, 1.2 x 6.5
- » PH Screwdriver
  - » PH0, PH1, PH2
- » PZ Screwdriver
  - » PZ1, PZ2
- » Flat Insulated Screwdriver 0.5 x 3.0 mm

Item ID: **MD910N****11 PIECE SCREWDRIVER SET****CONTENTS**

- » Flat Screwdriver
  - » 0.5 x 3.0, 1.0 x 5.5 (x2) 75 mm and 150 mm, 1.2 x 6.5 38 mm and 150 mm
- » PH Screwdriver
  - » PH0, PH1, PH2 (x2) 38 mm and 100 mm
- » PZ Screwdriver
  - » PZ1, PZ2

Item ID: **MD911N**

**6 PIECE SCREWDRIVER SET FLAT, PH, PZ****CONTENTS**

- » Flat Screwdriver
- » 0,6 x 3,5, 1,0 x 5,5
- » PH Screwdriver
- » PH1, PH2
- » PZ Screwdriver
- » PZ1, PZ2

Item ID: **MD906N****12 PIECE SCREWDRIVER SET FLAT, PH, PZ****CONTENTS**

- » Flat Screwdriver
- » 0,5 x 2,5, 0,6 x 3,5, 0,8 x 4,0, 1,0 x 5,5, 1,2 x 6,5, 1,6 x 10,0
- » PH Screwdriver
- » PH0, PH1, PH2 (x2) 100 mm and 200 mm
- » PZ Screwdriver
- » PZ1, PZ2

Item ID: **MD912N****6 PIECE SCREWDRIVER SET FLAT, PH****CONTENTS**

- » Flat Screwdriver
- » 0,8 x 4,0, 0,5 x 3,0, 1,0 x 5,5, 1,2 x 6,5
- » PH Screwdriver
- » PH1, PH2

Item ID: **MD906N3**





# BITS & DRIVERS

## QUALITY YOU CAN TRUST

All TengTools bits with a hexagonal drive are designed and manufactured in accordance with the latest industrial standards. Screwdriver bits and socket bits are classified as consumables and thus are only guaranteed to meet dimensional standards.

An extensive range of bit drivers are available in the range including ratcheting drivers, stubby drivers and folding handle drivers for greater power transfer. A selection of drivers offer the option of storing bits in the handle so you do not have to waste time searching for bits when you need them.



Bit sets supplied in handy pocket sized storage with bits that are easy to access. More belt clip sets have been added to the range to help you keep small tool sets in arms reach at all times.







**1/4" DOUBLE ENDED FLAT BITS**



ITEM ID:	SIZE	PACK QTY	DRIVE	LENGTH (mm)
FTF32406005	0.8 x 4;1.0 x 6	5	1/4" Hex	32



**1/4" FLAT BITS 50mm**



ITEM ID:	SIZE	PACK QTY	DRIVE	LENGTH (mm)
FL5006A03	0.6 x 3.5	3	1/4" Hex	50
FL5008A03	0.8 x 4.0	3	1/4" Hex	50
FL5008B03	0.8 x 5.5	3	1/4" Hex	50
FL5010A03	1.0 x 5.5	3	1/4" Hex	50
FL5012A03	1.2 x 6.5	3	1/4" Hex	50



**1/4" FLAT BITS 25mm**



ITEM ID:	SIZE	PACK QTY	DRIVE	LENGTH (mm)
FL2506A03	0.6 x 3.5	3	1/4" Hex	25
FL2506B03	0.6 x 4.5	3	1/4" Hex	25
FL2508A03	0.8 x 4.0	3	1/4" Hex	25
FL2508B03	0.8 x 5.5	3	1/4" Hex	25
FL2510A03	1.0 x 5.5	3	1/4" Hex	25
FL2512A03	1.2 x 6.5	3	1/4" Hex	25
FL2516A03	1.6 x 8.0	3	1/4" Hex	25



**1/4" FLAT BITS 70mm**



ITEM ID:	SIZE	PACK QTY	DRIVE	LENGTH (mm)
FL7006A02	0.6 x 3.5	2	1/4" Hex	70
FL7008A02	0.8 x 4.0	2	1/4" Hex	70
FL7008B02	0.8 x 5.5	2	1/4" Hex	70
FL7010A02	1.0 x 5.5	2	1/4" Hex	70





**1/4" FLAT BITS 89mm**



ITEM ID:	SIZE	PACK QTY	DRIVE	LENGTH (mm)
FL8905A01	0.5 x 3.0	1	1/4" Hex	89
FL8908A01	0.8 x 4.0	1	1/4" Hex	89



**1/4" PH BITS 25mm**



ITEM ID:	SIZE	PACK QTY	DRIVE	LENGTH (mm)
PH2500103	PH1	3	1/4" Hex	25
PH2500110	PH1	10	1/4" Hex	25
PH2500203	PH2	3	1/4" Hex	25
PH2500210	PH2	10	1/4" Hex	25
PH2500303	PH3	3	1/4" Hex	25
PH2500310	PH3	10	1/4" Hex	25



**1/4" DOUBLE ENDED PH BITS**



ITEM ID:	SIZE	PACK QTY	DRIVE	LENGTH (mm)
PHH32000305	PH0;PH3	5	1/4" Hex	32
PHH32010205	PH1;PH2	5	1/4" Hex	32



**1/4" PH BITS 50mm**



ITEM ID:	SIZE	PACK QTY	DRIVE	LENGTH (mm)
PH5000103	PH1	3	1/4" Hex	50
PH5000203	PH2	3	1/4" Hex	50
PH5000303	PH3	3	1/4" Hex	50





**1/4" PH BITS 70mm**



ITEM ID:	SIZE	PACK QTY	DRIVE	LENGTH (mm)
PH7000102	PH1	2	1/4" Hex	70
PH7000202	PH2	2	1/4" Hex	70



**1/4" PH BITS 89mm**



ITEM ID:	SIZE	PACK QTY	DRIVE	LENGTH (mm)
PH8900101	PH1	1	1/4" Hex	89
PH8900201	PH2	1	1/4" Hex	89



**1/4" PH IMPACT BITS**



ITEM ID:	SIZE	PACK QTY	DRIVE	LENGTH (mm)
PHP3000101	PH1	1	1/4" Hex	30
PHP3000105	PH1	5	1/4" Hex	30
PHP3000201	PH2	1	1/4" Hex	30
PHP3000205	PH2	5	1/4" Hex	30
PHP3000301	PH3	1	1/4" Hex	30
PHP3000305	PH3	5	1/4" Hex	30
PHP5000101	PH1	1	1/4" Hex	50
PHP5000201	PH2	1	1/4" Hex	50
PHP5000301	PH3	1	1/4" Hex	50
PHP8900201	PH2	1	1/4" Hex	89



**1/4" PH G BITS 25mm**



ITEM ID:	SIZE	PACK QTY	DRIVE	LENGTH (mm)
GR25002010	PH2G	10	1/4" Hex	25
GR25002100	PH2G	100	1/4" Hex	25





**1/4" PH G IMPACT BITS**

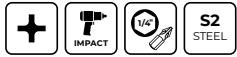

ITEM ID:	SIZE	PACK QTY	DRIVE	LENGTH (mm)
GRP3000201	PH2G	1	1/4" Hex	30
GRP3000205	PH2G	5	1/4" Hex	30
GRPS000201	PH2G	1	1/4" Hex	50



**1/4" PZ BITS**

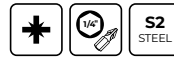

ITEM ID:	SIZE	PACK QTY	DRIVE	LENGTH (mm)
PZ2500103	PZ1	3	1/4" Hex	25
PZ2500110	PZ1	10	1/4" Hex	25
PZ2500203	PZ2	3	1/4" Hex	25
PZ2500210	PZ2	10	1/4" Hex	25
PZ2500303	PZ3	3	1/4" Hex	25
PZ2500310	PZ3	10	1/4" Hex	25



**1/4" DOUBLE ENDED PZ BITS**



ITEM ID:	SIZE	PACK QTY	DRIVE	LENGTH (mm)
PZZ32000305	PZ0,PZ3	5	1/4" Hex	32
PZZ32010205	PZ1,PZ2	5	1/4" Hex	32



**1/4" PZ BITS 50mm**



ITEM ID:	SIZE	PACK QTY	DRIVE	LENGTH (mm)
PZ5000103	PZ1	3	1/4" Hex	50
PZ5000203	PZ2	3	1/4" Hex	50
PZ5000303	PZ3	3	1/4" Hex	50







**1/4" PZ BITS 70mm**



ITEM ID:	SIZE	PACK QTY	DRIVE	LENGTH (mm)
PZ7000102	PZ1	2	1/4" Hex	70
PZ7000202	PZ2	2	1/4" Hex	70



**1/4" PZ IMPACT BITS**



ITEM ID:	SIZE	PACK QTY	DRIVE	LENGTH (mm)
PZP3000101	PZ1	1	1/4" Hex	30
PZP3000105	PZ1	5	1/4" Hex	30
PZP3000201	PZ2	1	1/4" Hex	30
PZP3000205	PZ2	5	1/4" Hex	30
PZP3000301	PZ3	1	1/4" Hex	30
PZP3000305	PZ3	5	1/4" Hex	30
PZP5000101	PZ1	1	1/4" Hex	50
PZP5000201	PZ2	1	1/4" Hex	50
PZP5000301	PZ3	1	1/4" Hex	50
PZP8900201	PZ2	1	1/4" Hex	89



**1/4" PZ BITS 89mm**



ITEM ID:	SIZE	PACK QTY	DRIVE	LENGTH (mm)
PZ8900101	PZ1	1	1/4" Hex	89
PZ8900201	PZ2	1	1/4" Hex	89



**1/4" DOUBLE ENDED TX BITS**



ITEM ID:	SIZE	PACK QTY	DRIVE	LENGTH (mm)
TXX32101505	TX10;TX15	5	1/4" Hex	32
TXX32202505	TX20;25	5	1/4" Hex	32





**1/4" TX BITS 25mm**



ITEM ID:	SIZE	PACK QTY	DRIVE	LENGTH (mm)
TX2500603	TX6	3	1/4" Hex	25
TX2500703	TX7	3	1/4" Hex	25
TX2500803	TX8	3	1/4" Hex	25
TX2500903	TX9	3	1/4" Hex	25
TX2501003	TX10	3	1/4" Hex	25
TX2501503	TX15	3	1/4" Hex	25
TX2502003	TX20	3	1/4" Hex	25
TX2502503	TX25	3	1/4" Hex	25
TX2502703	TX27	3	1/4" Hex	25
TX2503003	TX30	3	1/4" Hex	25
TX2504003	TX40	3	1/4" Hex	25



**1/4" TX BITS 50mm**



ITEM ID:	SIZE	PACK QTY	DRIVE	LENGTH (mm)
TX5000803	TX8	3	1/4" Hex	50
TX5001003	TX10	3	1/4" Hex	50
TX5001503	TX15	3	1/4" Hex	50
TX5002003	TX20	3	1/4" Hex	50
TX5002503	TX25	3	1/4" Hex	50
TX5002703	TX27	3	1/4" Hex	50
TX5003003	TX30	3	1/4" Hex	50



**1/4" TX BITS 70mm**



ITEM ID:	SIZE	PACK QTY	DRIVE	LENGTH (mm)
TX7001002	TX10	2	1/4" Hex	70
TX7001502	TX15	2	1/4" Hex	70
TX7002002	TX20	2	1/4" Hex	70
TX7002502	TX25	2	1/4" Hex	70





**1/4" TX BITS 89mm**



ITEM ID:	SIZE	PACK QTY	DRIVE	LENGTH (mm)
TX8901001	TX10	1	1/4" Hex	89
TX8902001	TX20	1	1/4" Hex	89
TX8902501	TX25	1	1/4" Hex	89
TX8903001	TX30	1	1/4" Hex	89



**1/4" TX IMPACT BITS**



ITEM ID:	SIZE	PACK QTY	DRIVE	LENGTH (mm)
TXP3001001	TX10	1	1/4" Hex	30
TXP3001005	TX10	5	1/4" Hex	30
TXP3001501	TX15	1	1/4" Hex	30
TXP3001505	TX15	5	1/4" Hex	30
TXP3002001	TX20	1	1/4" Hex	30
TXP3002005	TX20	5	1/4" Hex	30
TXP3002501	TX25	1	1/4" Hex	30
TXP3002505	TX25	5	1/4" Hex	30
TXP3002701	TX27	1	1/4" Hex	30
TXP3002705	TX27	5	1/4" Hex	30
TXP3003001	TX30	1	1/4" Hex	30
TXP3003005	TX30	5	1/4" Hex	30
TXP3004001	TX40	1	1/4" Hex	30
TXP3004005	TX40	5	1/4" Hex	30
TXP5001001	TX10	1	1/4" Hex	50
TXP5001501	TX15	1	1/4" Hex	50
TXP5002001	TX20	1	1/4" Hex	50
TXP5002501	TX25	1	1/4" Hex	50
TXP5002701	TX27	1	1/4" Hex	50
TXP5003001	TX30	1	1/4" Hex	50
TXP5004001	TX40	1	1/4" Hex	50
TXP8902001	TX20	1	1/4" Hex	89
TXP8902501	TX25	1	1/4" Hex	89
TXP8903001	TX30	1	1/4" Hex	89





**TX BITS 40mm**



ITEM ID:	SIZE	PACK QTY	DRIVE	LENGTH (mm)
220708	TX08	1	10mm Hex	40
220710	TX10	1	10mm Hex	40
220715	TX15	1	10mm Hex	40
220720	TX20	1	10mm Hex	40
220725	TX25	1	10mm Hex	40
220727	TX27	1	10mm Hex	40
220730	TX30	1	10mm Hex	40
220740	TX40	1	10mm Hex	40
220745	TX45	1	10mm Hex	40
220750	TX50	1	10mm Hex	40
220755	TX55	1	10mm Hex	40
220760	TX60	1	12mm Hex	40
220770	TX70	1	12mm Hex	40



**TX BITS 75mm**



ITEM ID:	SIZE	PACK QTY	DRIVE	LENGTH (mm)
220820	TX20	1	10mm Hex	75
220825	TX25	1	10mm Hex	75
220827	TX27	1	10mm Hex	75
220830	TX30	1	10mm Hex	75
220840	TX40	1	10mm Hex	75
220845	TX45	1	10mm Hex	75
220850	TX50	1	10mm Hex	75
220855	TX55	1	10mm Hex	75
220860	TX60	1	12mm Hex	75
220870	TX70	1	12mm Hex	75



**1/4" TPX BITS 25mm**



ITEM ID:	SIZE	PACK QTY	DRIVE	LENGTH (mm)
TPX2501003	TPX10	3	1/4" Hex	25
TPX2501503	TPX15	3	1/4" Hex	25
TPX2502003	TPX20	3	1/4" Hex	25
TPX2502503	TPX25	3	1/4" Hex	25
TPX2502703	TPX27	3	1/4" Hex	25
TPX2503003	TPX30	3	1/4" Hex	25
TPX2504003	TPX40	3	1/4" Hex	25





1/4" HEX BITS 25mm



ITEM ID:	SIZE	PACK QTY	DRIVE	LENGTH (mm)
HEX2500203	2	3	1/4" Hex	25
HEX2500303	3	3	1/4" Hex	25
HEX2500403	4	3	1/4" Hex	25
HEX2500503	5	3	1/4" Hex	25
HEX2500603	6	3	1/4" Hex	25
HEX2500803	8	3	1/4" Hex	25



1/4" HEX BITS 50mm



ITEM ID:	SIZE	PACK QTY	DRIVE	LENGTH (mm)
HEX5000403	4	3	1/4" Hex	50
HEX5000503	5	3	1/4" Hex	50
HEX5000603	6	3	1/4" Hex	50
HEX5000803	8	3	1/4" Hex	50



1/4" HEX BITS 89mm



ITEM ID:	SIZE	PACK QTY	DRIVE	LENGTH (mm)
HEX8900401	4	1	1/4" Hex	89



1/4" HEX IMPACT BITS



ITEM ID:	SIZE	PACK QTY	DRIVE	LENGTH (mm)
HEXP3000301	3	1	1/4" Hex	30
HEXP3000305	3	5	1/4" Hex	30
HEXP3000401	4	1	1/4" Hex	30
HEXP3000405	4	5	1/4" Hex	30
HEXP3000501	5	1	1/4" Hex	30
HEXP3000505	5	5	1/4" Hex	30
HEXP3000601	6	1	1/4" Hex	30
HEXP3000605	6	5	1/4" Hex	30
HEXP5000301	3	1	1/4" Hex	50
HEXP5000401	4	1	1/4" Hex	50
HEXP5000501	5	1	1/4" Hex	50
HEXP5000601	6	1	1/4" Hex	50





**HEX BITS 40mm**



ITEM ID:	SIZE	PACK QTY	DRIVE	LENGTH (mm)
210705	5	1	10mm Hex	40
210706	6	1	10mm Hex	40
210707	7	1	10mm Hex	40
210708	8	1	10mm Hex	40
210709	9	1	10mm Hex	40
210710	10	1	10mm Hex	40
210712	12	1	12mm Hex	40
210714	14	1	12mm Hex	40
210717	17	1	12mm Hex	40
210719	19	1	12mm Hex	40



**HEX BITS 75mm**



ITEM ID:	SIZE	PACK QTY	DRIVE	LENGTH (mm)
210805	5	1	10mm Hex	75
210806	6	1	10mm Hex	75
210807	7	1	10mm Hex	75
210808	8	1	10mm Hex	75
210809	9	1	10mm Hex	75
210810	10	1	10mm Hex	75
210812	12	1	12mm Hex	75
210814	14	1	12mm Hex	75
210817	17	1	12mm Hex	75
210819	19	1	12mm Hex	75



**1/4" ROB BITS 25mm**



ITEM ID:	SIZE	PACK QTY	DRIVE	LENGTH (mm)
ROB2500103	1	3	1/4" Hex	25
ROB2500203	2	3	1/4" Hex	25
ROB2500303	3	3	1/4" Hex	25







**1/4" ROB IMPACT BITS**



ITEM ID:	SIZE	PACK QTY	DRIVE	LENGTH (mm)
ROBP3000101	1	1	1/4" Hex	30
ROBP3000105	1	5	1/4" Hex	30
ROBP3000201	2	1	1/4" Hex	30
ROBP3000205	2	5	1/4" Hex	30
ROBP5000101	1	1	1/4" Hex	50
ROBP5000201	2	1	1/4" Hex	50
ROBP5000301	3	1	1/4" Hex	50
ROBP8900101	1	1	1/4" Hex	89
ROBP8900201	2	1	1/4" Hex	89
ROBP8900301	3	1	1/4" Hex	89



**1/4" NUT SETTER**



ITEM ID:	TYPE	SIZE	DRIVE	LENGTH (mm)
NS45108M	Magnetic	1/4"	1/4"	45
NS45506M	Magnetic	6 mm	1/4"	46
NS45507M	Magnetic	7 mm	1/4"	49
NS45508M	Magnetic	8 mm	1/4"	47
NS45508R	Ring	8 mm	1/4"	48



**1/4" IMPACT NUT SETTER**



ITEM ID:	SIZE	DRIVE	LENGTH (mm)
NSP65108	1/4"	1/4"	65
NSP65507	7 mm	1/4"	65
NSP65508	8 mm	1/4"	65
NSP65510	10 mm	1/4"	65
NSP65513	13 mm	1/4"	65





**1/4" MAGNETIC BIT HOLDER**



ITEM ID:	DRIVE	LENGTH (mm)	CHUCK TYPE
ACC50MBH01	1/4" Hex	50	Magnet
ACC70MBH01	1/4" Hex	70	Magnet
ACC35CBH01	1/4" Hex	35	Quick
ACC50CBH01	1/4" Hex	50	Quick



**1/4" QUICK CHUCK IMPACT BIT HOLDER**



ITEM ID:	DRIVE	LENGTH (mm)	CHUCK TYPE
QC114	1/4" Hex	60	Quick



**1/4" MAGNETIC IMPACT BIT HOLDER**



ITEM ID:	DRIVE	LENGTH (mm)	CHUCK TYPE
MBH114	1/4" Hex	60	Magnet



**1/4" IMPACT BIT ADAPTOR**



ITEM ID:	DRIVE	LENGTH (mm)
IBA14	1/4" Hex	50





**1/4" BITS DRIVER EXTENSION**



ITEM ID:	DRIVE	LENGTH (mm)	SHAFT TYPE
TTMD74-1	1/4" Hex	100	Hexagon



**1/4" FLEXIBLE BIT HOLDER**



ITEM ID:	DRIVE	ADAPTER TYPE	LENGTH (mm)
ACC300CBH01	1/4" Hex	Hex bit coupler	300



**1/4" BITS DRIVER EXTENSION**



ITEM ID:	DRIVE	LENGTH (mm)	SHAFT TYPE
TTMD74-2	1/4" Hex	150	Flexible



**1/4" BIT ADAPTOR MALE**



ITEM ID:	DRIVE	ADAPTER TYPE	LENGTH (mm)
ACCSDA1414	1/4" Hex	Hex coupler	50
ACCSDA1438	1/4" Hex	Hex coupler	50
ACCSDA1412	1/4" Hex	Hex coupler	50





**1/4" MINI BITS RATCHET**

**1/4"** **72**  
PIECES TEETH

ITEM ID:	SIZE	NO. OF TEETH	REVERSE DIRECTION	LENGTH (mm)
1400B	8	72	Flip reverse lever	90



**5/16" BIT SET WITH 1/2" COUPLER TX 4 PIECES**

**4** **1/2"**  
PIECES

**CONTENTS**

- » 5/16" TX Impact Driver Bits
- » TX45, TX50, TX55
- » 1/2" Bit Adaptor 5/16" Hex

Item ID: **1488**



**BIT SET WITH 3/8" COUPLER TX 7 PIECES**

**7** **3/8"**  
PIECES

**CONTENTS**

- » 1/4" TX Bits 25mm
- » TX10, TX15, TX20, TX25, TX30, TX40
- » 3/8" Bit Adaptor Hex bit coupler 1/4" Hex

Item ID: **1486**



**BIT SET IPR 10 PIECES**

**10** **1/4"** **IPR**  
PIECES

Item ID: **M1410T5**





**HOOK ON BIT SET MIXED 22 PIECES**



**CONTENTS**

- » 1/4" PH Bits 25mm
- » PH1, PH2, PH3
- » 1/4" Hex Bits 25mm
- » 3, 4, 5, 6
- » 1/4" TX Bits 25mm
- » TX10, TX15, TX20, TX25, TX30, TX40
- » 1/4" PH G Bits 25mm PH2G
- » 1/4" Bit Adaptor for 1/4" Sockets
- » 1/4" Flat Bits 25mm
- » 0.6 x 4.5, 0.8 x 5.5, 1.2 x 6.5
- » 1/4" PZ Bits 25mm
- » PZ1, PZ2, PZ3

Item ID: **THBS22**



**HOOK ON IMPACT BIT SET MIXED 22 PIECES**



**CONTENTS**

- » 1/4" PZ Impact Bits 30mm
- » PZ1, PZ2, PZ3
- » 1/4" TX Impact Bits 30mm
- » TX10, TX15, TX20, TX25, TX30, TX40
- » 1/4" PH G Impact Bits 30mm PH2G 1 pc
- » 1/4" Bit Adaptor for 1/4" Sockets
- » 1/4" Hex Impact Bits 30mm
- » 3, 4, 5, 6
- » 1/4" PH Impact Bits 30mm
- » PH1, PH2, PH3
- » 1/4" Magnetic Impact Bit Holder 60mm
- » 1/4" ROB Impact Bits 30mm
- » 1, 2

Item ID: **THBSI22**





### BIT SET WITH BELT CLIP MIXED 28 PIECES

**28**  
PIECES

**1/4"**

#### CONTENTS

- » 1/4" PH Bits 25mm
  - » PH1, PH2, PH3
- » 1/4" TPX Bits 25mm
  - » TPX20, TPX25, TPX30
- » 1/4" Quick Chuck Bit Holder 50mm
- » 1/4" Hex Bits 25mm
  - » 4, 5, 6
- » 1/4" TX Bits 25mm
  - » TX10, TX15, TX20, TX25, TX30, TX40
- » 1/4" PH G Bits 25mm PH2G 10 pcs
- » 1/4" ROB Bits 25mm
  - » 1, 2, 3
- » 1/4" Flat Bits 25mm
  - » 0.6 x 4.5, 0.8 x 5.5, 1.2 x 6.5
- » 1/4" PZ Bits 25mm
  - » PZ1, PZ2, PZ3
- » Hex Socket Adaptor 1/4" Hex - 1/4" 25mm

Item ID: **TJ028**



### BIT SET WITH BELT CLIP MIXED 29 PIECES

**29**  
PIECES

**1/4"**

#### CONTENTS

- » 1/4" PH Bits 25mm
  - » PH1, PH2, PH3
- » 1/4" TPX Bits 25mm
  - » TPX20, TPX25, TPX30
- » 1/4" Hex Bits 25mm
  - » 2, 3, 4, 5, 6, 8
- » 1/4" TX Bits 25mm
  - » TX10, TX15, TX20, TX25, TX30, TX40
- » 1/4" Magnetic Bit Holder 50mm
- » 1/4" ROB Bits 25mm
  - » 1, 2, 3
- » 1/4" PZ Bits 25mm
  - » PZ1, PZ2, PZ3
- » 1/4" Flat Bits 25mm
  - » 0.6 x 3.5, 1.0 x 5.5, 1.6 x 8.0
- » 1/4" Mini Bits Ratchet

Item ID: **TJ1429**







**IMPACT BIT SET WITH BELT CLIP MIXED 29 PIECES**



**CONTENTS**

- » 1/4" PZ Impact Bits 30mm  
PZ1, PZ2, PZ3
- » 1/4" TX Impact Bits 30mm  
TX10, TX15, TX20, TX25, TX27, TX30, TX40
- » 1/4" PH G Impact Bits 30mm PH2G
- » 1/4" Hex Impact Bits 30mm  
3, 4, 5, 6
- » 1/4" PH Impact Bits 30mm  
PH1, PH2, PH3
- » 1/4" Magnetic Impact Bit Holder 60mm
- » 1/4" ROB Impact Bits 30mm  
1, 2
- » 1/4" Quick Chuck Impact Bit Holder 60mm

Item ID: **TJ1430**



**IMPACT BIT SET CONSTRUCTION WITH BELT CLIP MIXED 12 PIECES**



**CONTENTS**

- » 1/4" PZ Impact Bits 30mm  
PZ1, PZ2, PZ3
- » 1/4" TX Impact Bits 30mm  
TX10, TX20, TX25, TX30
- » 1/4" PH G Impact Bits 30mm PH2G
- » 1/4" Magnetic Impact Bit Holder 60mm
- » 1/4" ROB Impact Bits 30mm  
1, 2
- » 1/4" PH Impact Bits 30mm PH2 1 pc

Item ID: **TJ1412**



**IMPACT BIT SET WITH BELT CLIP MIXED 12 PIECES****CONTENTS**

- » 1/4" PZ Impact Bits 30mm  
PZ1, PZ2
- » 1/4" PH G Impact Bits 30mm PH2G
- » 1/4" Hex Impact Bits 30mm  
3, 4, 5
- » 1/4" Magnetic Impact Bit Holder 60mm
- » 1/4" TX Impact Bits 30mm  
TX20, TX25, TX30
- » 1/4" ROB Impact Bits 30mm  
1, 2

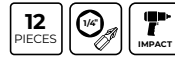
Item ID: **TJ1413****IMPACT BIT SET WITH BELT CLIP TX 12 PIECES****CONTENTS**

- » 1/4" TX Impact Bits 30mm  
TX10, TX15, TX20, TX25, TX27, TX30, TX40
- » 1/4" Magnetic Impact Bit Holder 60mm

Item ID: **TJ1414****IMPACT NUT SETTER SET WITH BELT CLIP 5 PIECES****CONTENTS**

- » 1/4" Impact Nut Setter  
1/4, 7, 8, 10, 13

Item ID: **TJNS05**



**5/16" IMPACT BIT SET MIXED 4 PIECES**



**CONTENTS**

- » 5/16" Flat Impact Driver Bits  
8, 10
- » 5/16" PH Impact Driver Bits  
PH2, PH3

Item ID: **ID506BIT**



**5/16" IMPACT BIT SET MIXED 13 PIECES**



**CONTENTS**

- » 5/16" Flat Impact Driver Bits  
6, 8, 10, 12
- » 5/16" PH Impact Driver Bits  
PH1, PH2, PH3, PH4
- » 5/16" Hex Impact Driver Bits  
4, 5, 6, 8
- » Hex Socket Adaptor 5/16" Hex - 3/8"

Item ID: **ID515BIT**



**5/16" IMPACT DRIVER BITS**



ITEM ID:	SIZE	PACK QTY	DRIVE	LENGTH (mm)
910504	4 Hex	1	5/16" Hex	44
910505	5 Hex	1	5/16" Hex	45
910506	6 Hex	1	5/16" Hex	46
910508	8 Hex	1	5/16" Hex	47
910510	10 Hex	1	5/16" Hex	36
920001	PZ1	1	5/16" Hex	36
920002	PZ2	1	5/16" Hex	36
920003	PZ3	1	5/16" Hex	36
940006	Flat 6	1	5/16" Hex	36
940008	Flat 8	1	5/16" Hex	37
940010	Flat 10	1	5/16" Hex	38
940012	Flat 12	1	5/16" Hex	39
930001	PH1	1	5/16" Hex	40
930002	PH2	1	5/16" Hex	41
930003	PH3	1	5/16" Hex	42
930004	PH4	1	5/16" Hex	43
970030	TX30	1	5/16" Hex	36
970040	TX40	1	5/16" Hex	36
970045	TX45	1	5/16" Hex	36
970050	TX50	1	5/16" Hex	36
970055	TX55	1	5/16" Hex	36





**1/2" & 5/16" IMPACT DRIVER SET 6 PIECES**



**CONTENTS**

- » 5/16" Flat Impact Driver Bits  
8, 10
- » 5/16" PH Impact Driver Bits  
PH2, PH3

Item ID: **ID506**



**1/4" IMPACT DRIVER SET 7 PIECES**



**CONTENTS**

- » 1/4" Screw Extractor  
1, 2, 3
- » 1/4" PH Bits 50mm  
PH1, PH2
- » 1/4" Flat Bits 50mm 5mm

Item ID: **IDSE7**



**5/16" IMPACT BIT SET MIXED 13 PIECES**



**CONTENTS**

- » 5/16" Flat Impact Driver Bits  
6, 8, 10, 12
- » 5/16" PH Impact Driver Bits  
PH1, PH2, PH3, PH4
- » 5/16" Hex Impact Driver Bits  
4, 5, 6, 8
- » 1/2" Impact Coupler Adaptor 5/16" Hex
- » Hex Socket Adaptor 5/16" Hex - 3/8"

Item ID: **ID515**





**1/4" STUBBY BITS DRIVER**



ITEM ID:	LENGTH (mm)	SHAFT LENGTH (mm)	SHAFT TYPE	HDL SIZE	CHUCK TYPE
MDBH	70	12	Round	XS	Magnet



**1/4" MAGNETIC BITS DRIVER 217mm**



ITEM ID:	LENGTH (mm)	SHAFT LENGTH (mm)	SHAFT TYPE	HDL SIZE	CHUCK TYPE
MD216	217	101	Hexagon	L	Magnet



**1/4" MAGNETIC BITS DRIVER 193mm**



ITEM ID:	LENGTH (mm)	SHAFT LENGTH (mm)	SHAFT TYPE	HDL SIZE	CHUCK TYPE
MD193	193	85	Round	M	Magnet



**1/4" LONG FLEXIBLE BITS DRIVER**



ITEM ID:	LENGTH (mm)	SHAFT LENGTH (mm)	SHAFT TYPE	HDL SIZE	CHUCK TYPE
MD907FL	555	425	Flexible	XL	Magnet





**1/4" T HANDLE QUICK CHUCK BITS DRIVER**



ITEM ID:	LENGTH (mm)	SHAFT LENGTH (mm)	SHAFT TYPE	CHUCK TYPE
MDTHQ	75 x 130	75	Round	Quick



**1/4" QUICK CHUCK BITS DRIVER 183mm**



ITEM ID:	LENGTH (mm)	SHAFT LENGTH (mm)	SHAFT TYPE	HDL SIZE	CHUCK TYPE
MDQ183	183	75	Round	M	Quick



**1/4" QUICK CHUCK BITS DRIVER 147mm**



ITEM ID:	LENGTH (mm)	SHAFT LENGTH (mm)	SHAFT TYPE	HDL SIZE	CHUCK TYPE
MDQ147	147	30	Round	L	Quick



**1/4" QUICK CHUCK BITS DRIVER 217mm**



ITEM ID:	LENGTH (mm)	SHAFT LENGTH (mm)	SHAFT TYPE	HDL SIZE	CHUCK TYPE
MDQ217	217	101	Hexagon	L	Quick







**1/4" STUBBY RATCHETING BITS DRIVER SET**



**CONTENTS**

- » 1/4" PH Bits 25mm  
PH1, PH2
- » 1/4" Flat Bits 25mm  
1.0 x 5.5, 1.4 x 7.0
- » 1/4" PZ Bits 25mm  
PZ1, PZ2
- » Hex Socket Adaptor 1/4" Hex - 1/4" 25mm

Item ID: **MDR908S**



**1/4" RATCHETING BITS DRIVER DOUBLE END BITS SET**



**CONTENTS**

- » 1/4" Double Ended TX Bits  
TX10;TX15, TX20;TX25
- » 1/4" Double Ended PH Bits  
PH0;PH3, PH1;PH2
- » 1/4" Double Ended Flat Bits 4mm x 6mm
- » 1/4" Double Ended PZ Bits  
PZ0;PZ3, PZ1;PZ2

Item ID: **MDR915**



**1/4" RATCHETING BITS DRIVER SET**



**CONTENTS**

- » 1/4" PH Bits 25mm  
PH1, PH2
- » 1/4" Flat Bits 25mm  
1.0 x 5.5, 1.4 x 7.0
- » 1/4" PZ Bits 25mm  
PZ1, PZ2
- » Hex Socket Adaptor 1/4" Hex - 1/4" 25mm

Item ID: **MDR908**



**1/4" RATCHETING ANGLED BITS DRIVER SET**



**CONTENTS**

- » 1/4" PH Bits 25mm  
PH1, PH2
- » 1/4" Flat Bits 25mm  
1.0 x 5.5, 1.4 x 7.0
- » 1/4" PZ Bits 25mm  
PZ1, PZ2
- » Hex Socket Adaptor 1/4" Hex - 1/4" 25mm

Item ID: **MDRT908**





### 1/4" RATCHETING QUICK CHUCK BITS DRIVER



#### CONTENTS

- » 1/4" PH Bits 25mm  
PH1, PH2
- » 1/4" Flat Bits 25mm  
1.0 x 5.5, 1.4 x 7.0
- » 1/4" PZ Bits 25mm  
PZ1, PZ2
- » Hex Socket Adaptor 1/4" Hex - 1/4" 25mm

Item ID: **MDRQ908**



# HEX & TX KEYS

## VERSATILE, STRONG AND DURABLE

TengTools wide range of hex & TX keys consists of a range of keys made of chrome vanadium steel for industrial use and a series made of chrome-molybdenum for heavy duty usage.



CHROME VANADIUM STEEL

Stronger, harder and more durable than regular carbon steels. This guarantees the high level of quality that you would expect from a TengTools item

Our cases are designed to hold the wrenches tight enough so they didn't fall out but with a flexible enough grip that they were are still easily removed

For higher torque applications it is better to use the straight end Hex keys for maximum fastener engagement

Available in metric & imperial sizes up to 36 mm or 5/8"



CHROME MOLYBDENUM STEEL

It is an alloy tool steel with chromium (Cr), molybdenum (Mo), iron (Fe) and carbon (C) alloy elements. The highest quality steel that we use. It is particularly hard and strong, but also has an amount of flex. Ideal to use when more torque is required.

Ballpoint heads are ideal for areas that are hard to reach. Fastenings can be turned at an angle of 25° in a Hex or TX key.





D-57240





## HEX KEY METRIC



ITEM ID:	SIZE	LENGTH (mm)
3105007	0.7	8 x 35
3105009	0.9	10 x 38
3105013	1.3	12 x 41
3105015	1.5	14 x 45
310502	2	16 x 50
3105025	2.5	18 x 56
310503	3	20 x 63
310504	4	25 x 70
3105045	4.5	26 x 75
310505	5	28 x 80
3105055	5.5	30 x 85
310506	6	32 x 90
310507	7	34 x 95
310508	8	36 x 100
310509	9	38 x 106
310510	10	40 x 112
310511	11	42 x 118
310512	12	45 x 125
310514	14	56 x 140
310516	16	60 x 152
310517	17	63 x 160
310518	18	66 x 170
310519	19	70 x 180
310522	22	80 x 200
310527	27	100 x 250
310532	32	125 x 315
310536	36	140 x 355



## HEX KEY AF



ITEM ID:	SIZE	LENGTH (mm)
310102	1/16	14 x 44
3101025	5/64	15 x 48
310103	3/32	17 x 51
3101035	7/64	18 x 54
310104	1/8	19 x 57
3101045	9/64	20 x 64
310105	5/32	21 x 64
310106	3/16	24 x 70
310107	7/32	26 x 76
310108	1/4	28 x 83
310110	5/16	32 x 95
310112	3/8	35 x 108
310114	7/16	38 x 121
310116	1/2	41 x 133
310120	5/8	48 x 159



### EXTRA LONG HEX KEY METRIC



ITEM ID:	SIZE	LENGTH (mm)
3205015	1.5	14 x 90
320502	2	16 x 100
3205025	2.5	18 x 112
320503	3	20 x 126
320504	4	24 x 140
320505	5	28 x 160
320506	6	32 x 180
320508	8	36 x 200
320510	10	40 x 224



### BALL POINT HEX KEY METRIC

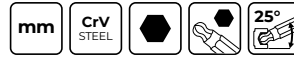

ITEM ID:	SIZE	LENGTH (mm)
3105015BL-C	1.5	14 x 77
310502BL-C	2	16 x 83
3105025BL-C	2.5	18 x 90
310503BL-C	3	20 x 98
310504BL-C	4	25 x 106
310505BL-C	5	28 x 118
310506BL-C	6	32 x 137
310507BL-C	7	34 x 147
310508BL-C	8	36 x 156
310510BL-C	10	40 x 170
310512BL-C	12	45 x 207
310514BL-C	14	56 x 230
310517BL-C	17	63 x 250
310519BL-C	19	70 x 280





### BALL POINT HEX KEY CR-MO METRIC



ITEM ID:	SIZE	LENGTH (mm)
3905015BL	1.5	14 x 77
390502BL	2	16 x 83
3905025BL	2.5	18 x 90
390503BL	3	20 x 98
390504BL	4	25 x 106
390505BL	5	28 x 118
390506BL	6	32 x 137
390508BL	8	36 x 156
390510BL	10	40 x 170



### EXTRA LONG BALL POINT HEX KEY METRIC

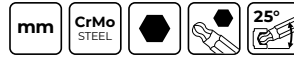

ITEM ID:	SIZE	LENGTH (mm)
3908015BL	1.5	14 x 90
3908020BL	2	16 x 100
3908025BL	2.5	18 x 112
390803BL	3	20 x 126
390804BL	4	25 x 140
390805BL	5	28 x 160
390806BL	6	32 x 180
390808BL	8	36 x 200
390810BL	10	40 x 224







### BALL POINT HEX KEY AF



ITEM ID:	SIZE	LENGTH (mm)
3101025BL	5/64	15 x 82
310103BL	3/32	17 x 88
310104BL	1/8	19 x 96
310105BL	5/32	21 x 105
310106BL	3/16	24 x 114
310107BL	7/32	26 x 124
310108BL	1/4	28 x 135
310110BL	5/16	32 x 151
310112BL	3/8	35 x 170



### BALL POINT HEX KEY CR-MO AF

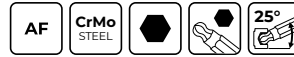

ITEM ID:	SIZE	LENGTH (mm)
3901025BL	5/64	15 x 82
390103BL	3/32	17 x 88
390104BL	1/8	19 x 96
390105BL	5/32	21 x 105
390106BL	3/16	24 x 114
390107BL	7/32	26 x 124
390108BL	1/4	28 x 135
390110BL	5/16	32 x 151
390112BL	3/8	35 x 170





### T HANDLE HEX KEY METRIC



ITEM ID:	SIZE	LENGTH (mm)
5106025	2.5	15 x 100
510603	3	15 x 100
510604	4	15 x 100
510605	5	18 x 150
510606	6	18 x 151
510607	7	18 x 152
510608	8	18 x 190



### T HANDLE BALL POINT HEX KEY METRIC



ITEM ID:	SIZE	LENGTH (mm)
510502	2	12 x 100
5105025	2.5	12 x 100
510503	3	12 x 100
510504	4	12 x 100
510505	5	15 x 150
510506	6	15 x 150
510507	7	15 x 150
510508	8	18 x 190
510510	10	20 x 200
510512	12	20 x 200



**T HANDLE BALL POINT HEX KEY AF**

ITEM ID:	SIZE	LENGTH (mm)
510103	3/32	12 x 100
510104	1/8	12 x 100
510105	5/32	12 x 100
510106	3/16	12 x 100
510107	7/32	15 x 150
510108	1/4	15 x 150
510110	5/16	18 x 190

**NEW****HEX KEY SET AF MINI 7 PIECES****CONTENTS**

- » Hex Key AF
- » .028, .035, .050, 1/16, 3/32, 5/64, 7/64

Item ID: **1477AF****NEW****HEX KEY SET METRIC MINI 7 PIECES****CONTENTS**

- » Hex Key Metric
- » 0.9, 1.3, 1.5, 2, 2.5, 3, 4

Item ID: **1477MM****HEX KEY SET 9 PIECES****CONTENTS**

- » Hex Key Metric
- » 1.5, 2, 2.5, 3, 4, 5, 6, 8, 10

Item ID: **1479MMR**



### EXTRA LONG HEX KEY SET 9 PIECES



#### CONTENTS

- » Extra Long Hex Key Metric
- » 1.5, 2, 2.5, 3, 4, 5, 6, 8, 10

Item ID: **1479MMRL**



### BALL POINT HEX KEY SET 9 PIECES



#### CONTENTS

- » Ball Point Hex Key Metric
- » 1.5, 2, 2.5, 3, 4, 5, 6, 8, 10

Item ID: **1479MM**



### BALL POINT HEX KEY SET 7 PIECES



#### CONTENTS

- » Ball Point Hex Key Metric
- » 2.5, 3, 4, 5, 6, 8, 10

Item ID: **1475**



### BALL POINT HEX KEY SET A 9 PIECES



#### CONTENTS

- » Ball Point Hex Key Metric
- » 1.5, 2, 2.5, 3, 4, 5, 6, 7, 10

Item ID: **1479MMA**



### BALL POINT HEX KEY SET CR-MO 9 PIECES



#### CONTENTS

- » Ball Point Hex Key CR-MO Metric
- » 1.5, 2, 2.5, 3, 4, 5, 6, 8, 10

Item ID: **1499MM**



### BALL POINT HEX KEY SET AF 7 PIECES



#### CONTENTS

- » Ball Point Hex Key AF
- » 1/8, 5/32, 3/16, 7/32, 1/4, 5/16, 3/8

Item ID: **1474**



### EXTRA LONG BALL POINT HEX KEY SET CR-MO 9 PIECES



#### CONTENTS

- » Extra Long Ball Point Hex Keys
- » 1.5, 2, 2.5, 3, 4, 5, 6, 8, 10

Item ID: **1499MML**



### BALL POINT HEX KEY SET AF 9 PIECES



#### CONTENTS

- » Ball Point Hex Key AF
- » 5/64, 3/32, 1/8, 5/32, 3/16, 7/32, 1/4, 5/16, 3/8

Item ID: **1479AF**





### BALL POINT HEX KEY SET CR-MO AF 9 PIECES



#### CONTENTS

- » Ball Point Hex Key CR-MO AF
- » 5/64, 3/32, 1/8, 5/32, 3/16, 7/32, 1/4, 5/16, 3/8

Item ID: **1499AF**



### FOLDING HEX KEY SET 2.5-10 mm ALU 7 PIECES



#### CONTENTS

- » Metric Hex Keys
- » 2.5, 3, 4, 5, 6, 8, 10

Item ID: **1476NMM1**



### FOLDING HEX KEY SET 1.5-6 mm ALU 7 PIECES



#### CONTENTS

- » Metric Hex Keys
- » 1.5, 2, 2.5, 3, 4, 5, 6

Item ID: **1476NMM**



### FOLDING HEX KEY SET 1.5-6 mm 7 PIECES



#### CONTENTS

- » Metric Hex Keys
- » 1.5, 2, 2.5, 3, 4, 5, 6

Item ID: **1471MM**





### FOLDING HEX KEY SET 2.5-10 mm 7 PIECES



#### CONTENTS

- » Metric Hex Keys
- » 1.5, 2, 2.5, 3, 4, 5, 6

Item ID: **1471MMA**



### FOLDING HEX KEY SET AF 7 PIECES



#### CONTENTS

- » AF Hex Keys
- » 1/16, 5/64, 3/32, 1/8, 5/32, 3/16, 7/32

Item ID: **1471AF**



### FOLDING HEX KEY SET AF ALU 7 PIECES



#### CONTENTS

- » AF Hex Keys
- » 1/16, 5/64, 3/32, 1/8, 5/32, 3/16, 7/32

Item ID: **1476NAF**



### FOLDING HEX KEY SET AF 6 PIECES



#### CONTENTS

- » AF Hex Keys
- » 1/8, 5/32, 3/16, 1/4, 5/16, 3/8

Item ID: **1471AFA**







### HEX KEY SET 10 PIECES



#### CONTENTS

- » Hex Key Metric
- » 1.5, 2, 2.5, 3, 4, 5, 6, 7, 8, 10

Item ID: **1425**



### HEX KEY SET AF 10 PIECES



#### CONTENTS

- » Hex Key AF
- » 1/16, 5/64, 3/32, 1/8, 5/32, 3/16, 7/32, 1/4, 5/16, 3/8

Item ID: **1424**



### TX KEY



ITEM ID:	SIZE	LENGTH (mm)
320008	TX8	16 x 80
320009	TX9	16 x 83
320010	TX10	17 x 86
320015	TX15	18 x 90
320020	TX20	19 x 95
320025	TX25	20 x 100
320027	TX27	22 x 105
320030	TX30	24 x 114
320040	TX40	26 x 124
320045	TX45	29 x 133
320050	TX50	32 x 152



### BALL POINT TX KEY



ITEM ID:	SIZE	LENGTH (mm)
320008BL	TX8	16 x 80
320009BL	TX9	16 x 83
320010BL	TX10	17 x 86
320015BL	TX15	18 x 90
320020BL	TX20	19 x 95
320025BL	TX25	20 x 100
320027BL	TX27	22 x 105
320030BL	TX30	24 x 114
320040BL	TX40	26 x 124
320045BL	TX45	29 x 133
320050BL	TX50	32 x 152



### BALL POINT TX KEY CR-MO



ITEM ID:	SIZE	LENGTH (mm)
390908BL	TX8	16 x 80
390909BL	TX9	16 x 83
390910BL	TX10	17 x 86
390915BL	TX15	18 x 90
390920BL	TX20	19 x 95
390925BL	TX25	20 x 100
390927BL	TX27	22 x 105
390930BL	TX30	24 x 114
390940BL	TX40	26 x 124



**T HANDLE BALL POINT TX KEY**

ITEM ID:	SIZE	LENGTH (mm)
520009	TX9	12 x 100
520010	TX10	12 x 100
520015	TX15	12 x 100
520020	TX20	12 x 100
520025	TX25	15 x 150
520027	TX27	15 x 150
520030	TX30	15 x 150
520040	TX40	18 x 190
520045	TX45	20 x 200
520050	TX50	20 x 200
520055	TX55	20 x 200

**TX KEY SET 9 PIECES****CONTENTS**

- » TX Key
- » TX8, TX9, TX10, TX15, TX20, TX25, TX27, TX30, TX40

Item ID: **1479TX****BALL POINT TX KEY SET 9 PIECES****CONTENTS**

- » Ball Point TX Key
- » TX8, TX9, TX10, TX15, TX20, TX25, TX27, TX30, TX40

Item ID: **1479TX1****BALL POINT TX KEY SET CR-MO 9 PIECES****CONTENTS**

- » Ball Point TX Key CR-MO
- » TX8, TX9, TX10, TX15, TX20, TX25, TX27, TX30, TX40

Item ID: **1499TX**



### FOLDING TX KEY SET 8 PIECES



#### CONTENTS

- » TX Keys
- » TX9, TX10, TX15, TX20, TX25, TX27, TX30, TX40

Item ID: **1476NTX**



### FOLDING TX KEY SET CR-MO 8 PIECES



#### CONTENTS

- » TX Keys
- » TX9, TX10, TX15, TX20, TX25, TX27, TX30, TX40

Item ID: **1476NTX2**



### FOLDING BALL POINT TX KEY SET 8 PIECES



#### CONTENTS

- » TX Keys
- » TX9, TX10, TX15, TX20, TX25, TX27, TX30, TX40

Item ID: **1476NTX1**



### TX KEY SET 7 PIECES



#### CONTENTS

- » TX Key
- » TX10, TX15, TX20, TX25, TX27, TX30, TX40

Item ID: **1487**



**TPX KEY CR-MO**CrMo  
STEEL

ITEM ID:	SIZE	LENGTH (mm)
390808TPX	TPX8	16 x 80
390809TPX	TPX9	16 x 83
390810TPX	TPX10	17 x 86
390815TPX	TPX15	18 x 90
390820TPX	TPX20	19 x 95
390825TPX	TPX25	20 x 100
390827TPX	TPX27	22 x 105
390830TPX	TPX30	24 x 114
390840TPX	TPX40	26 x 124

**FOLDING TPX KEY SET CR-MO 9 PIECES**CrMo  
STEEL**CONTENTS**

- » TPX Key CR-MO
- » TPX8, TPX9, TPX10, TPX15, TPX20, TPX25, TPX27, TPX30, TPX40

Item ID: **1498TPX****FOLDING KEY SET MIXED 8 PIECES**CrV  
STEEL**CONTENTS**

- » Bit Head Keys
  - » Flat 1 x 5.5, PH1, PZ2
- » Hex Keys
  - » 4, 5, 6
- » TX Keys
  - » TX25, TX30,

Item ID: **1477NX****BICYCLE KEY SET**

-

**CONTENTS**

- » Bit Head Keys
  - » Flat 1 x 5.5, PH2
- » Hex Keys
  - » 4, 5, 6
- » TX Keys
  - » TX25, TX30,
- » Tyre Lever and Chain Tool

Item ID: **1473**



TengTools ambassador  
**Vanessa Ruck**





# PLIERS

## DESIGNED TO MAXIMISE PERFORMANCE

The extensive TengTools range includes pliers for most applications. In addition, the range includes the usual side cutters, combination pliers and slip joint pliers as well as a number of cable pliers, side cutters for cable ties, frapping pliers, nail nippers, electronic pliers, precision shears and tweezers. Two types of handles are available to choose from: slim rubber dipped as well as ergonomic TPR bi-material handles.

Made from chrome molybdenum alloy steel for maximum durability and strength

The cutting capacity is laser marked next to the cutting edge makes it easy to see which pliers you need to choose

**TPR  
GRIP**

An ergonomic bi-material handle that is more comfortable in your hand

Extra support when using greater force and a lighter weight

The total length is designed to provide maximum leverage for each pair of pliers, irrespective of whether they are combination, water pump, flat or circlip pliers

### VINYL GRIP

A light compact material that is textured to avoid the tool slipping in your hand. The slim design allows for greater access in tight spaces









**SIDE CUTTING PLIER**



ITEM ID:	LENGTH (mm)	LENGTH (AF)				
MB441-5	135	5	1.5	1.8	2.3	4
MB441-6	160	6	1.6	2	2.5	4
MB442-5	140	5	1.5	1.8	2.3	4
MB442-6	160	6	2	2.5	3.8	4
MB442-7	180	7	2	2.5	4	4
MB442-8	200	8	2.5	3	4	4



**SIDE CUTTING PLIER TPR GRIP**



ITEM ID:	LENGTH (mm)	LENGTH (AF)	HIGH LEVERAGE	SPRING RETURN				
MB441-5T	140	5	No	No	1.5	1.8	2.3	4
MB441-6T	160	6	No	No	1.6	2	2.5	4
MB442-6T	165	6	No	No	2	2.5	3.8	4
MB442-8T	200	8	No	No	2.5	3	4	4



**HEAVY DUTY SIDE CUTTING PLIER WITH SPRING**



ITEM ID:	LENGTH (mm)	LENGTH (AF)	HIGH LEVERAGE	SPRING RETURN				
MB442-7S	180	7	Yes	Yes	2	2.5	4	4



**HEAVY DUTY SIDE CUTTING PLIER TPR GRIP**



ITEM ID:	LENGTH (mm)	LENGTH (AF)	HIGH LEVERAGE	SPRING RETURN				
MB442B-8T	200	8	Yes	No	2.5	3	4	4





**CABLE CUTTER**



ITEM ID:	LENGTH (mm)	LENGTH (AF)	CUTTING CAPACITY (mm <sup>2</sup> )
MB444-6	160	6	22
MB444-8	200	8	38
MB444-10	250	10	60



**HEAVY DUTY CABLE CUTTER BI MATERIAL HANDLE**



ITEM ID:	LENGTH (mm)	LENGTH (AF)	<b>Cu</b>
496	250	10	12



**CABLE CUTTER TPR GRIP**



ITEM ID:	LENGTH (mm)	LENGTH (AF)	CUTTING CAPACITY (mm <sup>2</sup> )
MB444-8T	208	8	38



**HEAVY DUTY CABLE CUTTER**



ITEM ID:	LENGTH (mm)	LENGTH (AF)	CUTTING CAPACITY (mm <sup>2</sup> )
MB445-10	250	10	60

- Piano Wire
- Steel Wire
- Hard Wire
- Stainless Steel Wire
- Medium Hard Wire
- Spring Steel Wire
- Soft Wire
- Iron Wire





**MINI BOLT CUTTER**



ITEM ID:	LENGTH (mm)	LENGTH (AF)			
BC408	200	8	3.6	4	5.2



**MINI BOLT CUTTER TPR GRIP**



ITEM ID:	LENGTH (mm)	LENGTH (AF)			
BC408T	200	8	3.6	4	5.2



**BOLT CUTTER**

ITEM ID:	LENGTH (mm)	LENGTH (AF)	CAPACITY (mm)
BC414	350	14	7 mm HRC15 or 4 mm HRC40
BC418	450	18	8 mm HRC15 or 5 mm HRC40
BC424	600	24	10 mm HRC15 or 6 mm HRC40
BC430	750	30	13 mm HRC15 or 7 mm HRC40
BC436	900	36	16 mm HRC15 or 8 mm HRC40

**SPARE PARTS FOR BOLT CUTTERS**

ITEM ID:	Description
BC414J	Spare Parts for Bolt Cutters Spare Jaws for BC414
BC418J	Spare Parts for Bolt Cutters Spare Jaws for BC418
BC424J	Spare Parts for Bolt Cutters Spare Jaws for BC424
BC430J	Spare Parts for Bolt Cutters Spare Jaws for BC430
BC436J	Spare Parts for Bolt Cutters Spare Jaws for BC436

	Piano Wire		Steel Wire
	Hard Wire		Stainless Steel Wire
	Medium Hard Wire		Spring Steel Wire
	Soft Wire		Iron Wire





**CABLE/WIRE CUTTER**



ITEM ID:	LENGTH (mm)	LENGTH (AF)		
498-7N	190	7	4	1.5



**END NIPPER**



ITEM ID:	LENGTH (mm)	LENGTH (AF)			
MB448-6	160	6	1.6	1.8	3.4
MB448-8	200	8	1.6	1.8	3.4



**FLUSH CUT PLIER**



ITEM ID:	LENGTH (mm)	LENGTH (AF)	HIGH LEVERAGE	SPRING RETURN
MB541-5	125	5	No	Yes
MB541-6	150	6	No	Yes
MB541-7	185	7	No	Yes



**CARPENTERS PLIER**



ITEM ID:	LENGTH (mm)	LENGTH (AF)		
MB489-7	180	7	1.6	2
MB489-8	200	8	1.8	2.2





**TOWER PINCER PLIER**



ITEM ID:	LENGTH (mm)	LENGTH (AF)			
MB449-9	220	9	1.8	2	3.4
MB449-10	250	10	2	2.2	3.8
MB449-11	280	11	2.5	3	4



**HEAVY DUTY COMBINATION PLIER TPR GRIP**



ITEM ID:	LENGTH (mm)	LENGTH (AF)	HIGH LEVERAGE			
MB452-6T	170	6	Yes	1.6	1.8	3.4
MB452-7T	190	7	Yes	1.8	2	3.8
MB452-8T	200	8	Yes	2	2.2	4



**COMBINATION PLIER**



ITEM ID:	LENGTH (mm)	LENGTH (AF)	HIGH LEVERAGE			
MB451-7	180	7	No	1.8	2	3.8
MB451-8	200	8	No	2	2.2	4
MB452-6	165	6	Yes	1.6	1.8	3.4
MB452-7	185	7	Yes	1.8	2	3.8
MB452-8	200	8	Yes	2	2.2	4
MB452-9	225	9	Yes	2	2.2	4



**LONG NOSE PLIER**



ITEM ID:	LENGTH (mm)	LENGTH (AF)			
MB461-5	140	5	1	1.5	2.5
MB461-6	165	6	1	1.5	2.5
MB461-8	200	8	1.5	1.8	2.8







**LONG NOSE PLIER TPR GRIP**



ITEM ID:	LENGTH (mm)	LENGTH (AF)			
MB461-6T	170	6	1	1.5	2.5
MB461-8T	205	8	1.5	1.8	2.8



**BENT LONG NOSE PLIER TPR GRIP**



ITEM ID:	LENGTH (mm)	LENGTH (AF)			
MB463-8T	210	8	1.5	1.8	2.8



**BENT LONG NOSE PLIER**



ITEM ID:	LENGTH (mm)	LENGTH (AF)			
MB463-5	140	5	1	1.5	2.5
MB463-6	160	6	1	1.5	2.5
MB463-8	200	8	1.5	1.8	2.8



**FLAT NOSE PLIER**



ITEM ID:	LENGTH (mm)	LENGTH (AF)
MB464-6	165	6

	Piano Wire		Steel Wire
	Hard Wire		Stainless Steel Wire
	Medium Hard Wire		Spring Steel Wire
	Soft Wire		Iron Wire







**FLAT NOSE PLIER TPR GRIP**



ITEM ID:	LENGTH (mm)	LENGTH (AF)
MB464-6T	170	6



**LONG REACH PLIER**



ITEM ID:	LENGTH (mm)	LENGTH (AF)	TYPE
AT094	275	11	Angled 90°
AT096	275	11	Straight
AT097	275	11	Angled 45°



**ROUND NOSE PLIER**



ITEM ID:	LENGTH (mm)	LENGTH (AF)
MB465-6	165	6



**GROOVE JOINT WATER PUMP PLIER**



ITEM ID:	LENGTH (mm)	LENGTH (AF)	CAPACITY (mm)
MB410	250	10	45
MB412	300	12	60
MB416	400	16	90





**WATER PUMP PLIER**



ITEM ID:	LENGTH (mm)	LENGTH (AF)	CAPACITY (mm)
MB481-7	180	7	3-25
MB481-10	240	10	3-38



**QUICK SET WATER PUMP PLIER HRC60**



ITEM ID:	LENGTH (mm)	LENGTH (AF)	CAPACITY (mm)
MB482-7Q	185	7	38
MB482-10Q	250	10	50
MB482-12Q	300	12	70



**WATER PUMP PLIER TPR GRIP**



ITEM ID:	LENGTH (mm)	LENGTH (AF)	CAPACITY (mm)
MB481-7T	185	7	3-25
MB481-10T	250	10	3-38



**QUICK SET WATER PUMP PLIER**



ITEM ID:	LENGTH (mm)	LENGTH (AF)	CAPACITY (mm)
MB481-10Q	245	10	3-38





**QUICK SET WATER PUMP PLIER TPR GRIP**



ITEM ID:	LENGTH (mm)	LENGTH (AF)	CAPACITY (mm)
MB481-10TQ	250	10	3-38



**QUICK SET WATER PUMP PLIER TPR GRIP HRC60**



ITEM ID:	LENGTH (mm)	LENGTH (AF)	CAPACITY (mm)
MB482-10TQ	250	10	50
MB482-12Q	300	12	70



**PLIER SET TOOL ROLL 5 PIECES**



**CONTENTS**

- » Mini Side Cutting Plier 115mm
- » Combination Plier 180mm
- » Water Pump Plier 240mm
- » Long Nose Plier 200mm
- » Side Cutting Plier 160mm

Item ID: **445W**



**CABLE TIE GUN**

ITEM ID:

CTG01





**WIRE STRIPPING PLIER TPR GRIP**



ITEM ID:	CAPACITY (mm)
MB499-7T	4,5



**WIRE STRIPPING PLIER GUN TYPE**

ITEM ID:	WIRE STRIPPING CAPACITY	WIRE STRIPPING CAPACITY (AWG)	
CP55	0.2 - 6.0	24 - 10	2



**WIRE TWISTING PLIER**

ITEM ID:
AT605



**CRIMPING PLIER**

ITEM ID:	BOLT SIZES	WIRE STRIPPING CAPACITY
CP50	M2.5 - M5	0.75 - 6.0



**RATCHETING CRIMPING PLIER WITH THREE HEADS**

ITEM ID:
CP52





**CRIMPING AND WIRE STRIPPING PLIER**

ITEM ID:	WIRE STRIPPING CAPACITY	WIRE STRIPPING CAPACITY (AWG)	
CP53	0.5 - 8.0	20 - 8	1



**RATCHETING WIRE STRIPPING PLIER**

ITEM ID:	WIRE STRIPPING CAPACITY	WIRE STRIPPING CAPACITY (AWG)
CP60	0.2 - 6.0	24 - 8



**RATCHETING CRIMPING PLIER**

ITEM ID:
CP58



**MINI SIDE CUTTING PLIER**



ITEM ID:	LENGTH (mm)	LENGTH (AF)	CAPACITY (mm)	SPRING RETURN
MBM441	115	5	0.8	Yes



**MINI END CUTTING PLIER**



ITEM ID:	LENGTH (mm)	LENGTH (AF)	CAPACITY (mm)	SPRING RETURN
MBM449	110	4.5	0.8	Yes





**MINI LONG NOSE PLIER**



ITEM ID:	LENGTH (mm)	LENGTH (AF)	CAPACITY (mm)	SPRING RETURN
MBM461	140	5	0.8	Yes



**MINI ROUND NOSE PLIER**



ITEM ID:	LENGTH (mm)	LENGTH (AF)	SPRING RETURN
MBM467	125	5	Yes



**MINI FLAT NOSE PLIER**



ITEM ID:	LENGTH (mm)	LENGTH (AF)	SPRING RETURN
MBM464	140	5.5	Yes



**MINI NEEDLE NOSE PLIER**



ITEM ID:	LENGTH (mm)	LENGTH (AF)	SPRING RETURN
MBM468	140	5.5	Yes



**Do's and Dont's of Pliers**

**DO'S**

- Use the right plier for the material
- Make sure the plier grips securely
- Use the right size plier
- Keep it clean & dry

**DONT'S**

- Do not use a plier that does not grip or cut the material
- Do not use on live electrics





**MINI BENT LONG NOSE PLIER**



ITEM ID:	LENGTH (mm)	LENGTH (AF)	SPRING RETURN
MBM469	140	5.5	Yes



**SELF LOCKING PLIER**

ITEM ID:	LENGTH (mm)	LENGTH (AF)	JAW TYPE
SLP3160	160	6	Serrated;Curved
SLP3180	180	7	Serrated;Curved



**TWEezer**

ITEM ID:	LENGTH (mm)	JAW TYPE
TW1180	180	Straight;Serrated



**TWEezer**

ITEM ID:	LENGTH (mm)	JAW TYPE
TW2125	125	Bent;Serrated



**TWEezer**

ITEM ID:	LENGTH (mm)	JAW TYPE
TW2160	160	Bent;Smooth







**TWEEZER**

ITEM ID:	LENGTH (mm)	JAW TYPE
TW2180	170	Z shape; Needle tip



**CIRCLIP PLIER INNER BENT PRO**

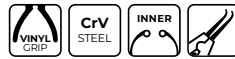

ITEM ID:	LENGTH (mm)	LENGTH (AF)	CAPACITY (mm)	SPRING RETURN
MBE471-5	125	5	12-25	Yes
MBE471-7	170	7	19-60	Yes
MBE471-9	220	9	40-100	Yes



**CIRCLIP PLIER INNER STRAIGHT PRO**



ITEM ID:	LENGTH (mm)	LENGTH (AF)	CAPACITY (mm)	SPRING RETURN
MBE470-5	135	5	12-25	Yes
MBE470-7	185	7	19-60	Yes
MBE470-9	235	9	40-100	Yes



**CIRCLIP PLIER OUTER STRAIGHT PRO**



ITEM ID:	LENGTH (mm)	LENGTH (AF)	CAPACITY (mm)	SPRING RETURN
MBE472-5	135	5	12-25	Yes
MBE472-7	175	7	19-60	Yes
MBE472-9	235	9	40-100	Yes





**CIRCLIP PLIER OUTER BENT PRO**



ITEM ID:	LENGTH (mm)	LENGTH (AF)	CAPACITY (mm)	SPRING RETURN
MBE473-5	125	5	12-25	Yes
MBE473-7	165	7	19-60	Yes
MBE473-9	220	9	40-100	Yes



**CIRCLIP PLIER INNER BENT**

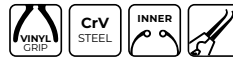

ITEM ID:	LENGTH (mm)	LENGTH (AF)	CAPACITY (mm)	SPRING RETURN
MB471-5	135	5	12-25	Yes
MB471-7	170	7	19-60	Yes
MB471-9	235	9	40-100	Yes



**CIRCLIP PLIER INNER STRAIGHT**



ITEM ID:	LENGTH (mm)	LENGTH (AF)	CAPACITY (mm)	SPRING RETURN
MB470-5	145	5	12-25	Yes
MB470-7	185	7	19-60	Yes
MB470-9	250	9	40-100	Yes



**CIRCLIP PLIER OUTER STRAIGHT**



ITEM ID:	LENGTH (mm)	LENGTH (AF)	CAPACITY (mm)	SPRING RETURN
MB472-5	145	5	12-25	Yes
MB472-7	180	7	19-60	Yes
MB472-9	240	9	40-100	Yes





**CIRCLIP PLIER OUTER BENT**



ITEM ID:	LENGTH (mm)	LENGTH (AF)	CAPACITY (mm)	SPRING RETURN
MB473-5	130	5	12-25	Yes
MB473-7	165	7	19-60	Yes
MB473-9	225	9	40-100	Yes



**CURVED JAW POWER GRIP PLIER**



ITEM ID:	LENGTH (mm)	LENGTH (AF)	CAPACITY (mm)
401-4	105	4	25
401-5	125	5	28
401-7	190	7	45
401-10	235	10	51
401-12	300	12	50



**CIRCLIP PLIER INTERCHANGEABLE TIPS**



ITEM ID:	CAPACITY (mm)	SPRING RETURN
480	10-50	Yes



**FLAT JAW POWER GRIP PLIER**



ITEM ID:	LENGTH (mm)	LENGTH (AF)	CAPACITY (mm)
401-10F	250	10	45
401-12F	300	12	52





**LONG NOSE POWER GRIP PLIER**



ITEM ID:	LENGTH (mm)	LENGTH (AF)	CAPACITY (mm)
404-4	125	4	35
404-6	170	6	50
404-9	230	9	70



**POWER GRIP PLIER SET**



**CONTENTS**

- » Curved Jaw Power Grip Plier 235mm
- » Long Nose Power Grip Plier 170mm

Item ID: **402**



**LONG NOSE POWER GRIP PLIER NON PINCH**



ITEM ID:	LENGTH (mm)	LENGTH (AF)	CAPACITY (mm)
404-6S	160	6	35



**C CLAMP POWER GRIP PLIER**



ITEM ID:	LENGTH (mm)	LENGTH (AF)	CAPACITY (mm)
406-6	172	6	0-50
406	280	11	0-80





**C CLAMP POWER GRIP PLIER NON PINCH**



ITEM ID:	LENGTH (mm)	LENGTH (AF)	CAPACITY (mm)
406-6S	172	6	0-50
406S	285	11	0-80



**SWIVEL C CLAMP POWER GRIP PLIER**



ITEM ID:	LENGTH (mm)	LENGTH (AF)	CAPACITY (mm)
406-6P	172	6	0-50
406P	280	11	0-80



**SWIVEL C CLAMP POWER GRIP PLIER NON PINCH**



ITEM ID:	LENGTH (mm)	LENGTH (AF)	CAPACITY (mm)
406-6SP	172	6	0-50
406SP	285	11	0-80



**C CLAMP LONG POWER GRIP PLIER**



ITEM ID:	LENGTH (mm)	LENGTH (AF)	CAPACITY (mm)
418S	450	18	0-150





**SWIVEL C CLAMP LONG POWER GRIP PLIER**



ITEM ID:	LENGTH (mm)	LENGTH (AF)	CAPACITY (mm)
418SP	450	18	0-150



**WELDING POWER GRIP PLIER NON PINCH**



ITEM ID:	LENGTH (mm)	LENGTH (AF)
407AS	270	11



**WELDING POWER GRIP PLIER**



ITEM ID:	LENGTH (mm)	LENGTH (AF)	CAPACITY (mm)
407	230	9	0-65



**SHEET METAL POWER GRIP PLIER**



ITEM ID:	LENGTH (mm)	LENGTH (AF)	CAPACITY (mm)
408	230	8	0-35



**SWIVEL CLAMPING POWER GRIP PLIER**

ITEM ID:	LENGTH (mm)	LENGTH (AF)	CAPACITY (mm)
409P	300	12	0-65

**TABLE CLAMP**

ITEM ID:	LENGTH (mm)	CAPACITY (mm)
410SP	230	0-65
410P	320	0-65

**SWIVEL CLAMPING POWER GRIP PLIER NON PINCH**

ITEM ID:	LENGTH (mm)	LENGTH (AF)	CAPACITY (mm)
409SP	300	12	0-88

**Power Grip Pliers**

- **Choose the right size:** Power grip pliers come in various sizes
- **Adjust the jaws:** Use the adjustment screw located near the handle to adjust the jaws to the desired width. Make sure the jaws are parallel and evenly spaced.
- **Apply the pliers:** Place the jaws of the power grip pliers around the object you want to grip. Close the jaws by squeezing the handles together.
- **Lock the pliers:** To lock the pliers in place, flip the small lever near the handle to the "locked" position. This will keep the pliers closed and maintain a firm grip on the object.
- **Apply force:** Use the power grip pliers to apply force, such as tightening or loosening a bolt or holding a piece of material in place.
- **Release the pliers:** To release the pliers, flip the lever back to the "unlocked" position and open the jaws by releasing the handles.





# INSULATED TOOLS

## PROTECT YOURSELF FROM ELECTRIC SHOCK

All 1000-volt tools from TengTools conform to or exceed all specifications that the relevant authorities have established. Each tool is individually tested before it is marked with a special standard tag and a marking that indicates the year of manufacture.



### INSULATED SCREWDRIVERS

The bi-material handle is designed for increased comfort and smooth action preventing blisters after continuous use. It gives better support and increased power transfer.

Size and tip marked at the bottom of each handle for easy identification

Integrated protective insulation with two colours to clearly indicate if there is any damage to the insulation

RBD shafts are ultra slim allowing for recessed screws to be accessed easily



TT-MV PLUS steel alloy for greater strength and material flexibility



### INSULATED RATCHET

Twist reverse mechanism for quickly changing between tightening and loosening

Insulation made in two parts, yellow insulating core and a red outer layer. Any damage to the insulation can be detected quickly with the visibility of the yellow core layer

72 Teeth ratchet give a working arc of just 5° making it ideal for working in confined spaces

Insulation properties have been tested in resistance to cold and fire as well as in pressurised environments

Ergonomically designed handle for increased comfort and smooth action







**FLAT SLIM INSULATED SCREWDRIVER**



ITEM ID:	SIZE	LENGTH (mm)	SHAFT LENGTH (mm)	HANDLE SIZE
MDV724N	0.8 x 4.0	208	100	M
MDV726N	1.0 x 5.5	233	125	M



**PH SLIM INSULATED SCREWDRIVER**



ITEM ID:	SIZE	LENGTH (mm)	SHAFT LENGTH (mm)	HANDLE SIZE
MDV742N	PH1	188	80	M
MDV744N	PH2	216	100	L



**FLAT INSULATED SCREWDRIVER**



ITEM ID:	SIZE	LENGTH (mm)	SHAFT LENGTH (mm)	HANDLE SIZE
MDV820N	0.4 x 2.5	171	75	S
MDV822N	0.5 x 3.0	196	100	S
MDV823N	0.6 x 3.5	196	100	S
MDV824N	0.8 x 4.0	208	100	M
MDV826N	1.0 x 5.5	233	125	M
MDV828N	1.2 x 6.5	266	150	L



**PH INSULATED SCREWDRIVER**



ITEM ID:	SIZE	LENGTH (mm)	SHAFT LENGTH (mm)	HANDLE SIZE
MDV840N	PH0	156	60	S
MDV842N	PH1	188	80	M
MDV844N	PH2	216	100	L
MDV846N	PH3	275	150	XL





**PZ SLIM INSULATED SCREWDRIVER**



ITEM ID:	SIZE	LENGTH (mm)	SHAFT LENGTH (mm)	HANDLE SIZE
MDV762N	PZ1	188	80	M
MDV764N	PZ2	216	100	L



**FLAT/PH INSULATED SCREWDRIVER**



ITEM ID:	SIZE	LENGTH (mm)	SHAFT LENGTH (mm)	HANDLE SIZE
MDV844NF	Flat/PH2	216	100	L
MDV864NF	Flat/PZ2	216	100	L



**PZ INSULATED SCREWDRIVER**



ITEM ID:	SIZE	LENGTH (mm)	SHAFT LENGTH (mm)	HANDLE SIZE
MDV860N	PZ0	156	60	S
MDV862N	PZ1	188	80	M
MDV864N	PZ2	216	100	L
MDV866N	PZ3	275	150	XL



**ROB INSULATED SCREWDRIVER**



ITEM ID:	SIZE	LENGTH (mm)	SHAFT LENGTH (mm)	HANDLE SIZE
MDV802N	2	216	100	L

Insulated according to IEC 60900, usable up to 1000 V  
 VDE tested, also in conformance to GPSC (Equipment and Product Safety Act)  
 Reduced blade diameter (RBD)





**INSULATED HANDLE FOR INTERCHANGEABLE BLADES**



ITEM ID:	LENGTH (mm)
MDV700	122



**INSULATED TORQUE SCREWDRIVER**



ITEM ID:	Nm	SCALE RESOLUTION	ACCURACY	CERTIFICATE	LENGTH (mm)	SHAFT L (mm)
1492TVSD	1-5	0.02	± 6%	Factory	213	82
1492TVSD-CT	1-5	0.02	± 6%	New	213	82



**INSULATED HANDLE FOR INTERCHANGEABLE BLADES**



ITEM ID:	LENGTH (mm)
MDV710	100



**Manufactured to the highest standard**

IEC 60 900 is an international standard for testing tools designed for electrical work on the production line

DIN EN 60900 is a European standard drawn up in 1995 and which states that each individual tool must be tested with regard to insulation for 1000 volts

VDE is an independent authority that tests and checks tools with regard to construction, production and packaging





**INTERCHANGEABLE BLADE INSULATED SCREWDRIVER**



ITEM ID:		SIZE	LENGTH (mm)	SHAFT LENGTH (mm)
MDV731	—	3	111	60
MDV732	—	4	151	100
MDV733	—	5.5	131	80
MDV734	—	6.5	151	100
MDV751	+	PH1	131	80
MDV752	+	PH2	151	100
MDV771	+	PZ1	131	80
MDV772	+	PZ2	151	100



**INSULATED INTERCHANGEABLE BLADE SET WALLET 9 PIECES**



**CONTENTS**

- » Insulated Handle for Interchangeable Blades L
- » Interchangeable Blade Insulated Screwdriver
- » 3, 4, 5.5, 6.5, PH1, PH2, PZ1, PZ2

Item ID: **MDV909N**



**INSULATED SCREWDRIVER SET FLAT & PH 6 PIECES**



**CONTENTS**

- » Flat Insulated Screwdriver
- » 0.4 x 2.5, 0.5 x 3.0, 0.8 x 4.0, 1.0 x 5.5
- » PH Insulated Screwdriver
- » PH1, PH2

Item ID: **MDV906N**



Insulated according to IEC 60900, usable up to 1000 V  
 VDE tested, also in conformance to GPSG (Equipment and Product Safety Act)



Reduced blade diameter (RBD)







**INSULATED SIDE CUTTING PLIER**



ITEM ID:	LENGTH (mm)	LENGTH (AF)			
MBV441-6	160	6	1.6	2	2.5



**INSULATED COMBINATION PLIER**



ITEM ID:	LENGTH (mm)	LENGTH (AF)			
MBV451-7	185	7	1.8	2	3.8
MBV451-8	200	8	2	2.2	4



**INSULATED SIDE CUTTING PLIER**



ITEM ID:	LENGTH (mm)	LENGTH (AF)			
MBV442-8	205	8	2.5	3	4



**INSULATED LONG NOSE PLIER**



ITEM ID:	LENGTH (mm)	LENGTH (AF)			
MBV461-8	215	8	1.5	1.8	2.8

Insulated according to IEC 60900, usable up to 1000 V  
 VDE tested, also in conformance to GPSPG (Equipment and Product Safety Act)

- Piano Wire
- Hard Wire
- Medium Hard Wire







**INSULATED WIRE STRIPPING PLIER**



ITEM ID:	CAPACITY (mm)	LENGTH (mm)	LENGTH (AF)
MBV499-7	4,5	160	6



**NEW**

**INSULATED CABLE CUTTER**



ITEM ID:	LENGTH (mm)	LENGTH (AF)	CUTTING CAPACITY (mm)
MBV444-8	210	8	38



**NEW**

**INSULATED LONG NOSE PLIER**



ITEM ID:	LENGTH (mm)	LENGTH (AF)			
MBV463-8	210	8	1	1.5	2.5



**NEW**

**INSULATED WATER PUMP PLIER**



ITEM ID:	CAPACITY (mm)	LENGTH (mm)	LENGTH (AF)
MBV482-10Q	3-38	260	10





**MECCA PRO INSULATED SCREWDRIVER & PLIER SET 18 PIECES**



**CONTENTS**

- » PH Insulated Screwdriver
  - » PH0, PH1, PH2, PH3
- » Insulated Long Nose Plier 215mm
- » Flat Insulated Screwdriver
  - » 0.4 x 2.5, 0.5 x 3.0, 0.8 x 4.0, 1.0 x 5.5, 1.2 x 6.5
- » Insulated Wire Stripping Plier
- » PZ Insulated Screwdriver
  - » PZ0, PZ1, PZ2, PZ3
- » Insulated Side Cutting Plier 205mm
- » Insulated Side Cutting Plier 160mm
- » Insulated Combination Plier 200mm

Item ID: **TV18N**



**3/8" INSULATED RATCHET**



ITEM ID:	REVERSE	LENGTH (mm)	LENGTH (AF)
MV3800	Twist	200	8



**3/8" INSULATED EXTENSION BAR**



ITEM ID:	LENGTH (mm)	LENGTH (AF)	INTERNAL DIAMETER (mm)
MV380020	75	3	23
MV380021	150	6	23





**3/8" INSULATED SOCKET**

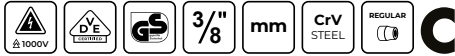

ITEM ID:	SIZE	LENGTH (mm)	SOCKET DIAMETER (mm)	INTERNAL DIAMETER (mm)
MV380506	6	46	14.8	23
MV380507	7	46	15.7	23
MV380508	8	46	17	23
MV380509	9	46	18.2	23
MV380510	10	46	19.4	23
MV380511	11	46	20.7	23
MV380512	12	46	23	23
MV380513	13	46	23	23
MV380514	14	46	24.7	23
MV380515	15	46	26	23
MV380516	16	46	26.8	23
MV380517	17	46	29	23
MV380518	18	46	29.6	23
MV380519	19	46	30.7	23
MV380520	20	46	32.2	23



**NEW**

**INSULATED KNIFE**



ITEM ID:	BLADE HEIGHT (mm)	BLADE LENGTH (mm)
MKV709	21	45



**NEW**

**REPLACEMENT BLADES FOR INSULATED KNIFE**



ITEM ID:	BLADE HEIGHT (mm)	BLADE LENGTH (mm)
MKV709A	21	45





**NEW**



### What are our insulated tools tested for?

- Insulation properties, i.e. resistance up to 1000 volts in dry or humid environments.
- Resistance to the cold, i.e. how well the tool withstands the cold
- Durability, i.e. that the insulating handles do not come loose
- Resistance to fire, i.e. how well the tool withstands fire
- Insulating properties under pressure, i.e. how well the tool maintains its insulating properties when subjected to pressure

### INSULATED SPANNER



ITEM ID:	SIZE	LENGTH (mm)	JAW DIAMETER (mm)	JAW HEIGHT (mm)
MPV600507	7	88	17.8	6.7
MPV600508	8	104	23	7.6
MPV600509	9	401	23	7.6
MPV600510	10	114	25	8.1
MPV600511	11	124.3	29.5	8.8
MPV600512	12	124.3	29.5	8.8
MPV600513	13	154	34	10.3
MPV600514	14	154	34	10.3
MPV600515	15	171	42	11
MPV600516	16	171	42	11
MPV600517	17	171	42	11
MPV600518	18	182	46.6	12
MPV600519	19	182	46.6	12
MPV600520	20	202	52	13
MPV600521	21	202	52	13
MPV600522	22	202	52	13
MPV600523	23	237	57	14
MPV600524	24	237	57	14





# CUTTING TOOLS

## BUILT TO LAST

TengTools tool boxes and tool cabinets have been designed to meet the high demands made by professionals from all over the world. No details are left to chance when our tool boxes and roller cabinets are manufactured.

A full range of storage accessories, side tables, side drawers and tool panels are available and can be placed on both sides of all TengTools roller cabinets.











**TIN SNIP**

CrMo  
STEEL

ITEM ID:	LENGTH (mm)	HANDLE TYPE			BLADE TYPE
490	250	Bi-material	0.9	1.5	Straight



**TIN SNIP**

CrMo  
STEEL

ITEM ID:	LENGTH (mm)	HANDLE TYPE			BLADE TYPE
492	250	Bi-material	0.9	1.5	Straight;Left



**TIN SNIP**

CrMo  
STEEL

ITEM ID:	LENGTH (mm)	HANDLE TYPE			BLADE TYPE
491	250	Bi-material	0.9	1.5	Straight;Right



**OFFSET TIN SNIP**

CrMo  
STEEL

ITEM ID:	LENGTH (mm)	HANDLE TYPE			BLADE TYPE
493	250	Bi-material	0.9	1.5	Offset;Right

	Piano Wire		Steel Wire
	Hard Wire		Stainless Steel Wire
	Medium Hard Wire		Spring Steel Wire
	Soft Wire		Iron Wire





**OFFSET TIN SNIP**



ITEM ID:	LENGTH (mm)	HANDLE TYPE			BLADE TYPE
494	250	Bi-material	0.9	1.5	Offset;Left



**TIN SNIP HIGH LEVERAGE**



ITEM ID:	LENGTH (mm)	HANDLE TYPE					BLADE TYPE
490W	250	Bi-material	1.8	1	0.9	1.5	Straight



**LONG TIN SNIP**



ITEM ID:	LENGTH (mm)	HANDLE TYPE			BLADE TYPE
495	275	Bi-material	0.5	0.9	Straight;Long cut



**TIN SNIP HIGH LEVERAGE**



ITEM ID:	LENGTH (mm)	HANDLE TYPE					BLADE TYPE
491W	250	Bi-material	1.8	1	0.9	1.5	Straight;Right





NEW



TIN SNIP COMPACT

CrMo  
STEEL

ITEM ID:	LENGTH (mm)	HANDLE TYPE			BLADE TYPE
491-7N	190	Bi-material	0.9	1.5	Straight



NEW



TIN SNIP COMPACT

CrMo  
STEEL

ITEM ID:	LENGTH (mm)	HANDLE TYPE			BLADE TYPE
494-7N	182	Bi-material	0.9	1.5	Straight;Left



NEW



TIN SNIP COMPACT

CrMo  
STEEL

ITEM ID:	LENGTH (mm)	HANDLE TYPE			BLADE TYPE
493-7N	182	Bi-material	0.9	1.5	Straight;Right

	Piano Wire		Steel Wire
	Hard Wire		Stainless Steel Wire
	Medium Hard Wire		Spring Steel Wire
	Soft Wire		Iron Wire





**TIN SNIP HIGH LEVERAGE**



ITEM ID:	LENGTH (mm)	HANDLE TYPE					BLADE TYPE
492W	250	Bi-material	1.8	1	0.9	1.5	Straight;Left



**INTRICATE CUTTING SCISSOR**

ITEM ID:	BLADE TYPE
SR1180	Straight;Sharp
SR2180	Straight;Blunt
SR3160	Sharp;Curved



**SCISSOR**

ITEM ID:	CAPACITY (mm)	BLADE TYPE
497	22	Straight





## Do's and Dont's of Hacksaws

### DO'S

- **Use the right blade:** Choose the right blade for the material you are cutting. A fine-toothed blade for thin metal, and a coarse-toothed blade for thicker materials.
- **Wear protective gear:** Wear safety glasses and gloves to protect yourself from flying debris.
- **Use the correct technique:** Hold the saw with both hands and use long, smooth strokes. Avoid twisting or bending the blade.
- **Keep the saw blade lubricated:** Lubricate the saw blade with a light oil to reduce friction.
- **Store the saw properly:** Store the saw in a dry place with the blade covered.

### DONT'S

- **Force the saw:** Do not apply excessive pressure on the saw, as this can damage the blade or cause it to break.
- **Use a dull blade:** Do not use a dull blade, as this can cause the saw to become stuck or make rough cuts.
- **Twist or bend the blade:** Do not twist or bend the blade while cutting, as this can cause it to break or become damaged.
- **Use the wrong blade:** Do not use the wrong blade for the material you are cutting, as this can cause the blade to wear down quickly or break.
- **Ignore safety gear:** Do not forget to wear protective gear such as safety glasses and gloves, as this can increase your risk of injury.



### HACKSAW AND KNIFE SET

#### CONTENTS

- » Hacksaw 24TPI Metal
- » Utility Knife
- » Mini Hacksaw 24TPI Metal

Item ID: **700-PRO5**



**HACKSAW**

ITEM ID:	BLADE LENGTH (mm)	TPI
701N1	300	24 Metal
702	300	24 Metal

**HACKSAW**

ITEM ID:	BLADE LENGTH (mm)	TPI
701	300	24 Metal

**HACKSAW**

ITEM ID:	BLADE LENGTH (mm)	TPI
701N	300	24 Metal

**FOLDING UTILITY SAW**

ITEM ID:	BLADE LENGTH (mm)	TPI	
703A	150	24 Metal; 10 Wood/Plastic	Sawzall blade fitting. Three positions for the blade (135°, 180° & 225°)
703A-10	150	10 Wood/Plastic	
703A-24	150	24 Metal	





**MINI HACKSAW**

ITEM ID:	BLADE LENGTH (mm)	TPI
705	150	24 Metal
705-5	150	24 Metal



**HACKSAW BLADE HOLDER**

ITEM ID:	BLADE LENGTH (mm)	TPI
704	300	24 Metal



**MINI HACKSAW**

ITEM ID:	BLADE LENGTH (mm)	TPI
705A		24 Metal; 16 Wood
705A-5	170	16 Wood



**DRILL BIT SET 1.0-10.0 mm 28 PIECES**

CONTENTS
» Drill Bits Fully Ground
» 1, 1.5, 2, 2.5, 3, 3.3, 3.5, 4, 4.2, 4.5, 5, 5.5, 6, 6.5, 6.8, 7, 7.5, 8, 8.5, 9, 9.5, 10

Item ID: **DB028**







### DRILL BIT SET 1.0-13.0 mm 34 PIECES

#### CONTENTS

- » Drill Bits Fully Ground
- » 1, 1.5, 2, 2.5, 3, 3.3, 3.5, 4, 4.2, 4.5, 5, 5.5, 6, 6.5, 6.8, 7, 7.5, 8, 8.5, 9, 9.5, 10, 10.5, 11, 11.5, 12, 12.5, 13

Item ID: **DB034**



### DRILL BITS FULLY GROUND

ITEM ID:	PACK QTY	SIZE	LENGTH (mm)
DBX010	10	1	34
DBX015	10	1.5	40
DBX020	10	2	49
DBX025	10	2.5	57
DBX030	10	3	61
DBX033	10	3.3	65
DBX035	10	3.5	70
DBX040	10	4	75
DBX042	10	4.2	75
DBX045	10	4.5	80
DBX050	10	5	86
DBX055	10	5.5	93
DBX060	10	6	93
DBX065	10	6.5	101
DBX068	10	6.8	109
DBX070	10	7	109
DBX075	10	7.5	109
DBX080	5	8	117
DBX085	5	8.5	117
DBX090	5	9	125
DBX095	5	9.5	125
DBX100	5	10	133
DBX105	5	10.5	133
DBX110	5	11	142
DBX115	5	11.5	142
DBX120	5	12	151
DBX125	5	12.5	151
DBX130	5	13	151





**TAP**



ITEM ID:	SIZE	HRC
TDT03050	M3x0,5	58
TDT04070	M4x0,7	58
TDT05080	M5x0,8	58
TDT06100	M6x1,0	58
TDT08125	M8x1,25	58
TDT10150	M10x1,5	58
TDT12175	M12x1,75	58



**DIE**



ITEM ID:	SIZE	HRC	DIAMETER (mm)
TDD03050	M3x0,5	58	25
TDD04070	M4x0,7	58	25
TDD05080	M5x0,8	58	25
TDD06100	M6x1,0	58	25
TDD08125	M8x1,25	58	25
TDD10150	M10x1,5	58	25
TDD12175	M12x1,75	58	25



**1/4" DIE CHUCK**



ITEM ID:	FOR SIZE
M140070	M3 - M12



**1/4" TAP CHUCK**



ITEM ID:	DIAMETER (mm)	FOR SIZE
M140071	20	M3-M8
M140072	25	M5-M12



## REPAIR KIT ADJUSTABLE TAP CHUCK

ITEM ID:

M140071RK

M140072RK



## TAP HANDLE

ITEM ID:

TAP-HNDL

FOR SIZE

M3 - M12



## DIE HANDLE

ITEM ID:

DIE-HNDL

FOR SIZE

M3-M12



## SNAP OFF KNIFE SET 4 PIECES

## CONTENTS

- » Snap Off Knife Knife 9mm Metal Casing
- » Snap Off Knife Knife 9mm Plastic Housing
- » Snap Off Knife 18mm Plastic Housing
- » Snap Off Knife 18mm Plastic Housing Lock

Item ID: 710S



## SNAP OFF KNIFE 9 MM

ITEM ID:	BLADE HEIGHT (mm)	SAFETY LOCK
710A	9	No





**SNAP OFF KNIFE 9 MM**

ITEM ID:	BLADE HEIGHT (mm)	SAFETY LOCK
710H	9	No



**SNAP OFF KNIFE 9 MM**

ITEM ID:	BLADE HEIGHT (mm)	SAFETY LOCK
710F	9	No



**SNAP OFF KNIFE 18 MM**

ITEM ID:	BLADE HEIGHT (mm)	SAFETY LOCK
710C	18	No



**SNAP OFF KNIFE 18 MM**

ITEM ID:	BLADE HEIGHT (mm)	SAFETY LOCK
710G	18	No



**REPLACEMENT SNAP OFF BLADES 9MM**

ITEM ID:	BLADE HEIGHT (mm)	No of Pieces
710A-10	9	10
710A-100	9	100



**REPLACEMENT SNAP OFF BLADES 18MM**

ITEM ID:	BLADE HEIGHT (mm)	No of Pieces
710F-10	18	10
710F-100	18	100





### MINI FOLDING UTILITY KNIFE

ITEM ID:	BLADE HEIGHT (mm)	BLADE LENGTH (mm)	SAFETY LOCK
P-UKF	9	28	No
710U-10	9	28	Replacement Blades



### SAFETY UTILITY KNIFE

ITEM ID:	BLADE HEIGHT (mm)	BLADE LENGTH (mm)	SAFETY LOCK
711	19	60	Yes



### UTILITY KNIFE

ITEM ID:	BLADE HEIGHT (mm)	BLADE LENGTH (mm)	SAFETY LOCK
710	19	60	No



### FOLDING UTILITY KNIFE

ITEM ID:	BLADE HEIGHT (mm)	BLADE LENGTH (mm)	SAFETY LOCK
712	19	60	No





**QUICK ACTION UTILITY KNIFE**

ITEM ID:	BLADE HEIGHT (mm)	BLADE LENGTH (mm)	SAFETY LOCK
710N	19	60	No



**REPLACEMENT HOOK BLADES UTILITY KNIFE**

ITEM ID:	BLADE HEIGHT (mm)	BLADE LENGTH (mm)	No of Pieces
710-10H	19	48	10
710-100H	19	48	100



**REPLACEMENT BLADES UTILITY KNIFE**

**S2**  
STEEL

ITEM ID:	BLADE HEIGHT (mm)	BLADE LENGTH (mm)	No of Pieces
710-10	19	60	10
710-100	19	60	100



**NEEDLE FILE**

ITEM ID:	TYPE	LENGTH (mm)	HANDLE TYPE
TTNF12-01	Flat	160	Vinyl

**NEEDLE FILE**

ITEM ID:	TYPE	LENGTH (mm)	HANDLE TYPE
TTNF12-04	Square	160	Vinyl

**NEEDLE FILE**

ITEM ID:	TYPE	LENGTH (mm)	HANDLE TYPE
TTNF12-02	Half round	160	Vinyl

**NEEDLE FILE**

ITEM ID:	TYPE	LENGTH (mm)	HANDLE TYPE
TTNF12-05	Round	160	Vinyl

**NEEDLE FILE**

ITEM ID:	TYPE	LENGTH (mm)	HANDLE TYPE
TTNF12-03	Triangular	160	Vinyl

**NEEDLE FILE**

ITEM ID:	TYPE	LENGTH (mm)	HANDLE TYPE
TTNF12-06	Flat point	160	Vinyl







**NEEDLE FILE**

ITEM ID:	TYPE	LENGTH (mm)	HANDLE TYPE
TTNF12-07	Knife type	160	Vinyl



**NEEDLE FILE**

ITEM ID:	TYPE	LENGTH (mm)	HANDLE TYPE
TTNF12-10	Oval	160	Vinyl



**NEEDLE FILE**

ITEM ID:	TYPE	LENGTH (mm)	HANDLE TYPE
TTNF12-08	Barrette	160	Vinyl



**NEEDLE FILE**

ITEM ID:	TYPE	LENGTH (mm)	HANDLE TYPE
TTNF12-11	Feather	160	Vinyl



**NEEDLE FILE**

ITEM ID:	TYPE	LENGTH (mm)	HANDLE TYPE
TTNF12-09	Crossing	160	Vinyl



**NEEDLE FILE**

ITEM ID:	TYPE	LENGTH (mm)	HANDLE TYPE
TTNF12-12	Round edge flat	160	Vinyl



**HAND FILE**

ITEM ID:	TYPE	LENGTH (mm)	HANDLE TYPE
FLFT10	Flat	250	Bi-material

**HAND FILE**

ITEM ID:	TYPE	LENGTH (mm)	HANDLE TYPE
FLRD10	Round	250	Bi-material

**HAND FILE**

ITEM ID:	TYPE	LENGTH (mm)	HANDLE TYPE
FLHF10	Flat	250	Bi-material

**HAND FILE**

ITEM ID:	TYPE	LENGTH (mm)	HANDLE TYPE
FLSQ10	Square	250	Bi-material

**HAND FILE**

ITEM ID:	TYPE	LENGTH (mm)	HANDLE TYPE
FLHR10	Half round	250	Bi-material

**HAND FILE**

ITEM ID:	TYPE	LENGTH (mm)	HANDLE TYPE
FLTR10	Triangular	250	Bi-material



# MEASURING TOOLS

## ACCURACY IS KEY

Our range of Measuring Tools have been developed by focusing on TengTools users requirements across the automotive & industrial sectors. All tools are available individually but are also available in the unique TengTools TT trays so you can add them to your existing tool kit or include them when you are building your ultimate tool kit.



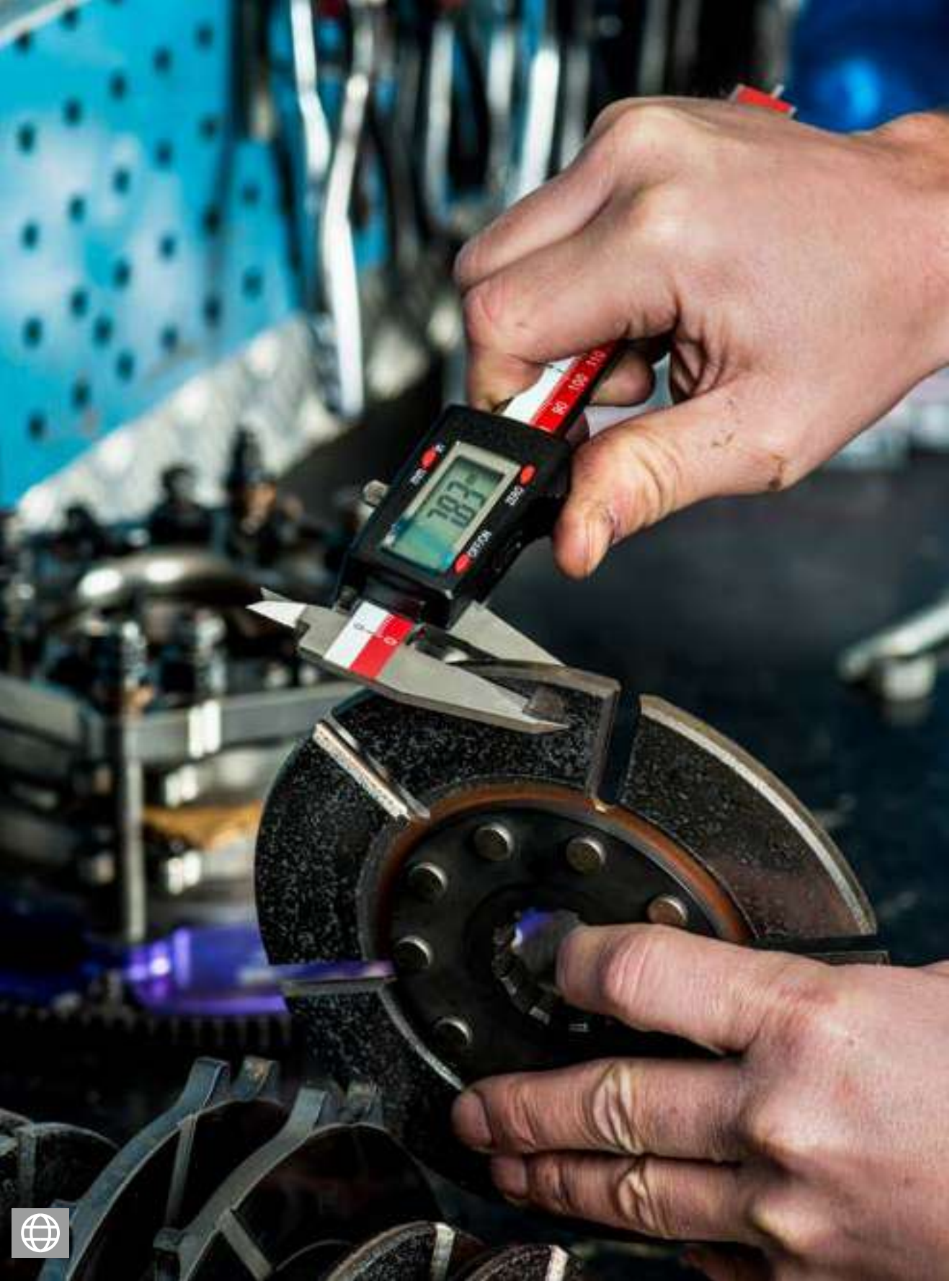



**MICROMETER**

mm

- Friction thimble and locking nut for easy operation
- Forged frame with hardened steel and polished measuring surfaces
- Matt chrome plated scale for easy reading
- Supplied with a plastic storage case
- Designed and manufactured to DIN863

ITEM ID:	MEASURING RANGE (mm)	SCALE RESOLUTION (mm)	ACCURACY
MIR25	0 - 25	0.01	0.004 mm



**DIGITAL CALIPER**

mm AF

- 4 function caliper to measure height, width, depth and step
- Adjustable between mm and inches
- Reset button and zero set in any position
- Automatic switch off to conserve batteries
- 0.01mm reading scale with 8mm high figures
- Uses CR2032 batteries (supplied)
- Supplied with a plastic storage case
- Designed and manufactured to DIN862

ITEM ID:	MEASURING RANGE (mm)	SCALE RESOLUTION (mm)	JAW DEPTH	ACCURACY
CALD150	0-150	0.01	40	± 0.02



**VERNIER CALIPER**

mm AF

- 4 function caliper to measure height, width, depth and step
- Metric and inch scales with 0.05mm and 1/128" scales
- Frosted chrome plated scale for easier reading
- Stainless steel construction with lapped edges
- Supplied with a plastic storage case
- Designed and manufactured to DIN862

ITEM ID:	MEASURING RANGE (mm)	SCALE RESOLUTION (mm)	JAW DEPTH
CALV150	0-150	0.05	40





### FEELER GAUGE

**mm**

- Blades for measuring from 0.05mm to 1.0mm
- Hardened rolled steel for durability and accuracy
- Fold up case with tightening screw for easy storage

ITEM ID:	NO. OF BLADES	MEASURING RANGE (mm)	BLADE LENGTH (mm)
FG13100	13	0,05-1,0	100
FG20100	20	0,05-1,0	100
FG20200	20	0,05-1,0	200



### DIAL GAUGE WITH MAGNETIC STAND

**mm**

- Aluminium dial indicator
- 57mm diameter dial with a turnable scale and two tolerance indexes
- An extra pointer indicates whole millimetres to make measurements simple
- The stand has central locking
- A strong magnet in the base to hold the stand in place when in use

ITEM ID:	MEASURING RANGE (mm)	SCALE RESOLUTION (mm)
DGMM	0-10	0.01



### GAUGE THREAD MM/UNC

**mm  
UNC**

- 54 blades in a handy holder with tightening screws
- Thread gauge 60°
- Suitable for measuring metric and UNC threads
- Manufactured from #45 steel for a long lasting gauge

ITEM ID:	NO. OF BLADES	MEASURING RANGE (mm)	MEASURING RANGE (UNC)
TGMMUNC	54	0.25-6.0	4-42



### STEEL RULE

**mm AF**

- Stainless steel to avoid corrosion
- Hanging hole for easy storage

ITEM ID:	LENGTH (mm)	WIDTH x THICKNESS (mm)
STMM150	150	20 x 0.8
ST200	200	20 x 0.8





**MEASURING TAPE METRIC/INCH**

mm AF

- ABS case for durability
- Rubberised grip for a more secure grip especially when wet or oily
- Tape lock and belt clip for secure storage when being used
- Power return tape for automatic rewinding
- Aligning hook for internal/external measurements
- Designed and manufactured to Cat II

ITEM ID:	LENTH (m)	LENGTH (ft)	WIDTH (mm)
MT03	3	10	13
MT05	5	16	19
MT08	8	26	25



**MEASURING TAPE METRIC**

mm

- ABS case for durability
- Rubberised grip for a more secure grip especially when wet or oily
- Tape lock and belt clip for secure storage when being used
- Power return tape for automatic rewinding
- Aligning hook for internal/external measurements
- Designed and manufactured to Cat II

ITEM ID:	LENTH (m)	WIDTH (mm)
MT03MM	3	13
MT05MM	5	19
MT08MM	8	25







**MEASURING TAPE CLOSED CASE**

mm AF

- High impact plastic case for durability
- Rubberised grip for a more secure grip especially when wet or oily
- Tape lock and belt clip for secure storage when being used
- Steel roller cage prevents damage to the case
- Aligning hook for internal/external measurements
- Designed and manufactured to Cat II

ITEM ID:	LENGTH (m)	WIDTH (m)
MT15	15	10



**TORPEDO SPIRIT LEVEL**

- Magnetic aluminium "torpedo" spirit level
- 3 magnets on the underside help fix the level to ferrous work pieces
- One horizontal, one vertical and one 45° angled vials
- Crush proof, durable vials with high transparency for easy reading
- Highly resistant to ultra violet light and fluctuations in temperature
- Shock absorbent end protectors to reduce the risk of damage
- Temperature proof vial mountings to reduce the risk of distortion

ITEM ID:	LENGTH (mm)	WIDTH (mm)	HEIGHT (mm)	TOLERANCE	WEIGHT (g)
SLT01	230	16	38	±1,0mm/m	144



**SPIRIT LEVEL MAGNETIC**

- Magnets on the underside help fix the level to ferrous work pieces
- Crush proof, durable vials with high transparency for easy reading
- Highly resistant to ultra violet light and fluctuations in temperature
- Shock absorbent end protectors to reduce the risk of damage
- Temperature proof vial mountings to reduce the risk of distortion

ITEM ID:	LENGTH (mm)	WIDTH (mm)	HEIGHT (mm)	TOLERANCE	TOLERANCE INVERTED	WEIGHT (g)
SLM0300	300	24	50	±0,75mm/m	±0,75mm/m	330
SLM0400	400	24	50	±0,75mm/m	±0,75mm/m	368
SLM0600	600	24	50	±0,75mm/m	±0,75mm/m	467
SLM1000	1000	24	50	±0,75mm/m	±0,75mm/m	834
SLM1200	1200	24	50	±0,75mm/m	±0,75mm/m	893





**CIRCUIT TESTER**

- Brass with steel probe and screw on cover
- Suitable for use between 6 and 24 volts
- 850mm cable with simple alligator grip
- Replacement bulb widely available (24 volt, 5 watt festoon type bulb)
- Simple to use to check if circuits are live and intact

ITEM ID:	WEIGHT (g)
9850	40



**DIGITAL MULTIMETER**

- Ideal for automotive or industrial maintenance
- Extra large digital display with 16mm digits
- Fold out stand for easier use
- Use to measure voltage in DC or AC and DC current
- Includes a diode and continuity tester
- Measure temperature with the temperature probe
- Supplied with test leads
- Uses 2 AAA batteries (supplied)
- CAT I 600 volts, CAT II 300 volts, IEC61010

ITEM ID:	MEASUREMENT RANGE (AC VOLTAGE)	MEASUREMENT RANGE (DC VOLTAGE)	RESISTANCE (OHMS)	TEMPERATURE (°CELSIUS)
DM550	250V	250V	200Ω - 2-20-200KΩ - 20MΩ	-40° - +1000°



**VOLTAGE TESTER**

ITEM ID:	SHAFT LENGTH (mm)	OVERALL LENGTH (mm)	MEASUREMENT RANGE (V)
MDV9855	70	145	105 - 250



**SLIDING BEVEL**

- Check edges for consistency by sliding the edge over the material
- Duplicate angles for marking by setting the adjustable blade
- Straight and true stainless steel blade for accuracy
- Plastic stock for reduced weight and a better grip

ITEM ID:	BLADE LENGTH (mm)	WIDTH (mm)	NET WEIGHT (g)
AB200	200	25	72





**TRY SQUARE**

mm

- Stainless steel blade with an anodised aluminium stock
- Blade measures 1.5 x 45mm with the stock being 18mm wide
- Milled working surface with deep etched markings
- Highly resistant to wear

ITEM ID:	BLADE LENGTH (mm)	ACCURACY	NET WEIGHT (g)
SQAA200	200	± 0.03 mm	224
SQAA250	250	± 0.03 mm	249
SQAA300	300	± 0.03 mm	275



**SQUARE BASE**

mm

- Zinc plated for corrosion resistance
- Base square design enables the square to be sat on a work surface

ITEM ID:	LENGTH (mm)	BLADE LENGTH (mm)
SQAB10070	100	70
SQAB150100	150	100
SQAB200130	200	130
SQAB300175	300	175

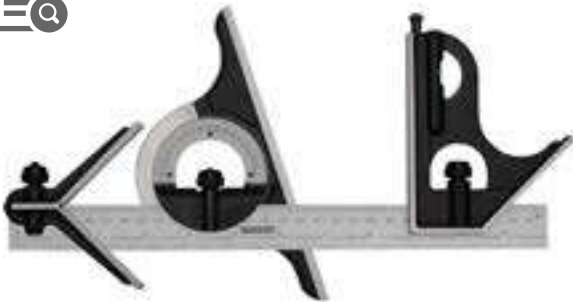

**SQUARE BASECOMBINATION SQUARE**

- Zinc plated for corrosion resistance
- Base square design enables the square to be sat on a work surface

ITEM ID:	PROTRACTOR READING	STEEL RULE LENGTH (mm)	SQUARE HEAD LENGTH (mm)	CENTRE HEAD LENGTH (mm)
SQAC300	0-180°	300	110	0-180°



# AUTO TOOLS

## ESSENTIALS FOR ANY GARAGE

When working on motors and general servicing it is vital that you have the right tools ready when you are. Whether it is a spark plug socket or hose clamps you need tools that are great to work with and bring better results.





- 
- 
- 
- 
- 
- 
- 
- 
- 
- 
- 
- 
- 
- 
- 
- 
- 
- 
- 
- 
-



**HOOK TOOL GREY HANDLE**

ITEM ID:	HOOK ANGLE	LENGTH (mm)	HANDLE
MDH-S	90°	245	Bi-material



**GASKET SCRAPER GREY HANDLE**

ITEM ID:	SIZE	LENGTH (mm)	HANDLE
MD-SCR	22	245	Bi-material



**HOOK TOOL GREY HANDLE**

ITEM ID:	LENGTH (mm)	HANDLE
MDH-L	200	Bi-material



**AWL**

ITEM ID:	LENGTH (mm)	HANDLE
MDA180	164	Bi-material



**AWL GREY HANDLE**

ITEM ID:	LENGTH (mm)	HANDLE
MDA-R	245	Bi-material



**HOOK TOOL**

ITEM ID:	HOOK ANGLE	LENGTH (mm)	HANDLE
MDP90	90°	164	Bi-material





**HOOK TOOL**

ITEM ID:	HOOK ANGLE	LENGTH (mm)	HANDLE
MDP35	35°	164	Bi-material



**NEW**



**CLIP & PANEL REMOVER TOOLS**

ITEM ID:	LENGTH (mm)	HANDLE
MRP06	208	Bi-material



**HOOK TOOL**

ITEM ID:	HOOK ANGLE	LENGTH (mm)	HANDLE
MDP125	125°	164	Bi-material



**NEW**



**CLIP & PANEL REMOVER TOOLS**

ITEM ID:	LENGTH (mm)	HANDLE
MDR08	231	Bi-material



**NEW**

**CLIP & PANEL REMOVER TOOLS**

ITEM ID:	LENGTH (mm)	HANDLE
MRP95	226	Bi-material



**NEW**

**CLIP & PANEL REMOVER TOOLS**

ITEM ID:	LENGTH (mm)	HANDLE
MDR06	223	Bi-material







**HOSE CLAMPS**

ITEM ID:	Capacity mm	Capacity AF
AT080	6 to 19	¼" to ¾"
AT085	6 to 32	¼" to 1-¼"
AT090	19 to 57	¾" to 2-¼"



**6mm/7mm HOSE CLIP DRIVER**

- Fits most commonly used worm drive hose clips such as Jubilee® hose clips
- Flexible shaft for easier access in confined spaces

Item ID: **MD503N**



**7mm HOSE CLIP DRIVER**

- Fits most commonly used worm drive hose clips such as Jubilee® hose clips
- Flexible shaft for easier access in confined spaces

Item ID: **MD503NA**



**8mm HOSE CLIP DRIVER**

- Fits most commonly used worm drive hose clips such as Jubilee® hose clips
- Flexible shaft for easier access in confined spaces

Item ID: **MD503ND**





**3/8" SPARK PLUG SOCKET**

3/8" 1/2"

ITEM ID:	SIZE (mm)	DRIVE	FLEXIBLE HEAD	LENGTH (mm)	THREAD SIZE
M380039-C	14	3/8"	No	64	8
M380040-C	16	3/8"	No	64	10
M380041-C	16	3/8"	Yes	85	10
M380042-C	18	3/8"	No	70	12
M380046-C	21	3/8"	No	70	14
M380047-C	21	3/8"	Yes	91	14
M120040-C	16	1/2"	No	70	10
M120042-C	18	1/2"	No	70	12
M120046-C	21	1/2"	No	70	14



**3/8" T-BAR SPARK PLUG SOCKET (MAGNETIC)**

3/8"

ITEM ID:	SIZE (mm)	FLEXIBLE HEAD	SOCKET LENGTH (mm)	OVERALL LENGTH (mm)	SOCKET DIAMETER	T-DRIVE FACILITY
TBUSP14	14	Yes	60	520	18.8	Yes
TBUSP16	16	Yes	60	520	21.8	Yes
TBUSP21	21	Yes	60	520	27.8	Yes



**SPARK PLUG BOOT PLIER**

ITEM ID:	LENGTH (mm)
SPBP20	250



**SPARK PLUG THREAD CLEANER**

ITEM ID:	SIZE	FOR THREADS	T-DRIVE FACILITY
TRC1012	10 x 12	10 x 1,12 x 1,25	No
TRC1418	14 x 18	14 x 1,25; 18 x 1,5	No





**OIL FILTER REMOVAL TOOL STRAP TYPE**

ITEM ID:	CAPACITY	LENGTH (mm)
9123	160	230
9123RK	REPLACEMENT STRAP	



**1/2" OIL FILTER REMOVAL TOOL STRAP TYPE**

1/2"

ITEM ID:	DRIVE	CAPACITY
9110	1/2"	130
9110RK-1	REPLACEMENT STRAP	



**OIL FILTER REMOVAL PLIER**

CrV  
STEEL

ITEM ID:	CAPACITY
409	53 - 118



**1/2" OIL FILTER REMOVAL TOOL CHAIN TYPE**

1/2"

ITEM ID:	DRIVE	CAPACITY
9120	1/2"	120
9120RK-1	REPLACEMENT CHAIN	





**1/2" HEAVY DUTY OIL FILTER REMOVAL TOOL**

1/2"

ITEM ID:	SIZE	DRIVE	CAPACITY
9120HD	24	1/2"	150



**DRAIN PLUG**

ITEM ID:	SIZE	LENGTH (mm)
DP0810	8 x 10	52
DP0812	8 x 3/8"	52
DP1012	5/16 x 3/8	52
DP1112	11	52
DP1314	13	52
DP1716	17 x 1/2"	52



**PISTON RING COMPRESSOR**

ITEM ID:	CAPACITY	T-DRIVE FACILITY
AT020	90-175	No



**ADJUSTABLE ENGINE CYLINDER HONING TOOL**

ITEM ID:	CAPACITY	T-DRIVE FACILITY
AT040	50-180	No
AT040-SM	REPLACEMENT 280 GRIT STONES (3 PIECES)	



**ADJUSTABLE BRAKE CYLINDER HONING TOOL**

ITEM ID:	SIZE
AT180	20-68
AT180-S	REPLACEMENT 220 GRIT STONES (3 PIECES)





**BRAKE DISC PAD PULLER**

ITEM ID:	PIN SIZE (mm)
AT330	5



**BALL JOINT SEPERATOR**

ITEM ID:	ADJUSTABLE HEIGHT (mm)	OPENING (mm)
AT191	0 - 60	29
AT192	0 - 80	40
AT194	0 - 100	46



**SPECIAL AUTO SOCKETS**

1/2"

ITEM ID:	SIZE	DRIVE	LENGTH (mm)	APPLICATION
AT350	29	1/2"	90	Oxygen Sensor Socket
AT355	22	3/8"	90	Oxygen Sensor Socket
AT360	27	1/2"	85	Injector Socket
AT365	7/8	3/8"	80	Vacuum Switch Socket
AT370	11/16	3/8"	74	Oil Sender Socket
AT375	7/8	1/2"	50	Heated Oxygen Sensor Socket
AT380	7/8	3/8"	30	Offset Oxygen Sensor Socket



**1/2" IMPACT SOCKET WHEEL NUT SET**

1/2" CrMo STEEL

CONTENTS
» 1/2" Impact Socket Wheel Nut
» 17, 19, 21

Item ID: 9203N



**TYRE LEVER**

ITEM ID:	LENGTH (mm)	LENGTH 2 (AF)
AT20512	304	12
AT20516	406	16
AT20520	508	20
AT20524	609	24

**1/2" WHEEL WRENCH**

ITEM ID:	SIZE	DRIVE	LENGTH (mm)
1202	17 x 19	1/2"	35-55
1202A	21 x 22	1/2"	35-55

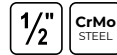
**1/2" DOUBLE ENDED IMPACT SOCKET SET****CONTENTS**

- » 1/2" Double Ended Impact Socket Metric 17 x 19, 21 x 22
- » 1/2" Impact Extension Bar ANSI 75mm

Item ID: **9203N1****1/2" IMPACT SOCKET WHEEL NUT**

ITEM ID:	SIZE	DRIVE	LENGTH (mm)	SOCKET DIAMETER	SOCKET DIAMETER 2
920517N	17	1/2"	85	26	32
920519N	19	1/2"	85	29	32
920521N	21	1/2"	85	29	32





**WING COVER**

ITEM ID:	LENGTH (mm)	Width (mm)
FC01	1070	400



**SUCTION LIFTER**

ITEM ID:	MAX LOAD (Kg)	CUP DIAMETER (mm)
SLO2	60	118



**SUCTION LIFTER**

ITEM ID:	MAX LOAD (Kg)	CUP DIAMETER (mm)
SL01	30	118



**SUCTION LIFTER**

ITEM ID:	MAX LOAD (Kg)	CUP DIAMETER (mm)
SL03	120	180





**BODY WORKING HAMMER - CROWN FACE, STRAIGHT PEIN**

**DOLLY**

ITEM ID:	LENGTH (mm)	FACE DIAMETER (mm)	HANDLE
HMBH01	325	32.5	Hickory

ITEM ID:	LENGTH (mm)
AT415	128
AT420	80



**BODY WORKING HAMMER - CROWN FACE, POINT PICK**

ITEM ID:	LENGTH (mm)	FACE DIAMETER (mm)	HANDLE
HMBH02	325	32.5	Hickory



**BODY WORKING HAMMER - CROWN FACE SQUARE MILLED**

ITEM ID:	LENGTH (mm)	FACE DIAMETER (mm)	HANDLE
HMBH03	325	32.5	Hickory



# SERVICE TOOLS

## DESIGNED TO HELP YOU GET THE JOB DONE

This range of service tools have been developed for you to do what you do best everyday. Here you will find tools that will help you perform most general service tasks more efficiently. All TengTools service tools have been manufactured to exceed the demands of professional users.







**TWO/THREE ARM PULLER**

ITEM ID:	Clamping Depth mm	Span Width mm	Weight g
SPA11	100	50-100	1080
SPA22	170	60-150	2600



**7" TWO/THREE ARM GEAR PULLER**

Item ID: **SP22**



**4" TWO/THREE ARM GEAR PULLER**

Item ID: **SP11**



**TWO ARM UNIVERSAL PULLER**

ITEM ID:	a1 mm	a2 mm	b mm	Spindle Thread	Spindle			e mm	Weight g
					Length mm	c mm	d mm		
SP1410	90	130	100	M14 x 1.5	140	17	12	3.4	1100
SP1810	130	170	100	M14 x 1.5	140	17	12	3.4	1300
SP2215	160	220	150	M20 x 2.0	210	22	20	3.8	3200
SP2615	200	256	150	M20 x 2.0	210	22	20	3.8	3600
SP3320	250	325	200	M26 x 2.0	280	27	27	6.2	7800

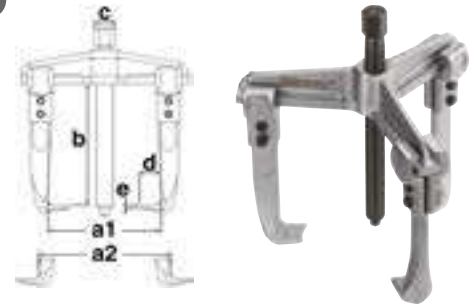
**THREE ARM UNIVERSAL PULLER**

ITEM ID:	a1 mm	a2 mm	b mm	Spindle Thread	Spindle			e mm	Weight g
					Length mm	c mm	d mm		
SP31410	90	140	100	M14 x 1.5	140	17	12	3.4	1400
SP31810	130	180	100	M14 x 1.5	140	17	12	3.4	1600
SP32215	160	220	150	M20 x 2.0	210	22	20	3.8	3500
SP32615	205	260	150	M20 x 2.0	210	22	20	3.8	4200
SP33320	252	330	200	M26 x 2.0	280	27	27	6.2	8800

**TWO ARM QUICK ACTION PULLER**

ITEM ID:	a1 mm	a2 mm	b mm	Spindle Thread	Spindle			e mm	Weight g
					Length mm	c mm	d mm		
SP1410Q	90	130	100	M14 x 1.5	140	17	12	3.4	1100
SP1810Q	130	170	100	M14 x 1.5	140	17	12	3.4	1200
SP2215Q	160	220	150	M20 x 2.0	210	22	20	3.8	3000
SP2615Q	200	256	150	M20 x 2.0	210	22	20	3.8	3400
SP3320Q	250	325	205	M26 x 2.0	280	27	27	6.2	7000

**THREE ARM QUICK ACTION PULLER**

ITEM ID:	a1 mm	a2 mm	b mm	Spindle Thread	Spindle			e mm	Weight g
					Length mm	c mm	d mm		
SP31410Q	90	140	100	M14 x 1.5	140	17	12	3.4	1500
SP31810Q	130	180	100	M14 x 1.5	140	17	12	3.4	1600
SP32215Q	160	220	150	M20 x 2.0	210	22	20	3.8	3900
SP32615Q	205	260	150	M20 x 2.0	210	22	20	3.8	4200
SP33320Q	252	330	205	M26 x 2.0	280	27	27	6.2	8600





5 Pieces

**PULLER SET WITH STAND**

2 Arm Pullers:

90/130mm spread, 130/170mm spread, 160/220mm spread, 200/256mm spread, 250/325mm spread

Item ID: **DIS-SP05**



5 Pieces

**PULLER SET QUICK TYPE WITH STAND**

2 Arm Pullers:

90/133mm spread, 130/170mm spread, 158/209mm spread, 200/256mm spread, 250/325mm spread

Item ID: **DIS-SP05Q**



**1/4" SCREW EXTRACTOR**

ITEM ID:	Size	Length mm	Weight g
SE141	1	50	12
SE142	2	50	12
SE143	3	50	12



**SCREW EXTRACTOR**

ITEM ID:	For Drill Hole mm	Weight g
SEL01S	3mm (1/8")	13
SEL02S	4mm (3/16")	22
SEL03S	5mm (15/64")	36
SEL04S	7mm (5/16")	52
SEL05S	9mm (3/8")	148







**TT  
SERIES**



Store x4 of these sets in a TCI Tray



**SCREW EXTRACTOR SET 5 PIECES**

- Screw Extractor  
1, 2, 3, 4, 5

Item ID: **TJSE05S**



**SCREW EXTRACTOR SET SPIRAL 5 PIECES**

Item ID: **SE05**



**5**  
Pieces

**NUT SPLITTER SET**

- Simply tighten the thread to engage the blade and split stubborn nuts
- Capacities 5 to 20mm and 14 to 27mm

**2**  
Pieces

Item ID: **NS02**

**REPAIR KIT NUT SPLITTER NS02**

ITEM ID:	Description
NS02RKS	Small
NS02RKL	Large

**5**  
Pieces







**1/2" STUD EXTRACTOR SOCKET**

1/2"

ITEM ID:	Drive	Size mm
ST12506-C	1/2"	6
ST12508-C	1/2"	8
ST12510-C	1/2"	10
ST12512-C	1/2"	12



**1/2" STUD EXTRACTOR ECCENTRIC**

1/2"

- For inserting and extracting stud bolts
- One eccentric knurled contact wheel grips the stud against an internal fluting
- Suitable for use with stud bolts from 5.5 to 19mm diameter thread

Item ID: **2300**



**STUD EXTRACTORS**

3/8"

1/2"

ITEM ID:	Drive	Size mm	Size AF	L mm	T mm	D1 mm	D2 mm	Weight g
ST38306	3/8"	6	1/4"	27	11	15.9	9.9	21
ST38308	3/8"	8	5/16"	27	11	15.9	12	23
ST38112	3/8"	-	3/8"	27	11	15.9	14.2	22
ST38310	3/8"	10	-	27	11	19	15.3	33
ST38311	3/8"	11	7/16"	27	11	19	15.6	33
ST38312	3/8"	12	-	27	11	19	17.4	33
ST38116	3/8"	-	1/2"	27	11	19	17.7	34
ST38313	3/8"	13	-	27	11	19	18.7	35
ST38314	3/8"	14	9/16"	27	11	22.2	20.7	50
ST38316	3/8"	16	5/8"	27	11	22.2	22.1	50
ST38317	3/8"	17	-	27	11	25.4	24.8	74
ST38122	3/8"	-	11/16"	27	11	25.4	24.8	74
ST12319	1/2"	19	3/4"	44.5	11	27	26.6	167
ST12321	1/2"	21	13/16"	44.5	12.5	32	28	199
ST12322	1/2"	22	7/8"	44.5	12.5	35	30.7	210
ST12324	1/2"	24	15/16"	44.5	12.5	36	32.4	210
ST12325	1/2"	25	1"	44.5	12.5	36	33.4	214





**PRY BAR ROLL HEEL TYPE**

ITEM ID:	Size AF	Size mm
PB12	12"	300
PB16	16"	400
PB20	20"	500



**PRY BAR**

ITEM ID:	Size AF	Size mm
PB12A	12"	300
PB18A	18"	450
PB22A	22"	550



**WRECKING BAR**

ITEM ID:	Overall Length
PF380	380mm (15")



**PIPE CUTTER 3-22mm CAPACITY**

Item ID: **TF22**



**PIPE CUTTER 3-32mm CAPACITY**

Item ID: **TF30**



**REPLACEMENT BLADES FOR TF22 AND TF30 PIPE CUTTERS 2 PIECES**

Item ID: **TF2230RK**





**PIPE CUTTER 6-76mm CAPACITY**

Item ID: **TF76**



**PIPE CUTTER 42mm CAPACITY PE TUBING**

Item ID: **TFP01**



**REPLACEMENT BLADE FOR TF76 PIPE CUTTERS 5 PIECES**

Item ID: **TF76RK**



**REPLACEMENT BLADE TFP01 PIPE CUTTERS 1 PIECE**

Item ID: **TFP01RK**





**PIPE CUTTER 42mm CAPACITY PLASTIC**

Item ID: **TFP02**



**PIPE CUTTER CHAIN TYPE**

Item ID: **TF300**



**REPLACEMENT BLADE TFP02 PIPE CUTTERS 1 PIECE**

Item ID: **TFP02RK**



**PIPE CUTTER REPLACEMENT CHAIN**

Item ID: **TF300RK**





**ROTATING PIPE CUTTER**

ITEM ID:	Pipe Diameter mm
TFA10	10
TFA12	12
TFA15	15
TFA22	22
TFA0252RK	5 spare wheels



**ALUMINIUM PIPE REAMER**

- For deburring pipes of all types
- Cutters at both ends for internal and external deburring

ITEM ID:	Pipe Diameter mm
DBT35	8 to 35mm
DBT54	10 to 54mm



**PLASTIC DEBURRING PIPE REAMER TOOL 3 TO 41MM**

- For deburring copper, aluminium and brass pipes
- Suitable for pipe diameters from 3 to 41mm
- Cutters at both ends for internal and external deburring

Item ID: **DBT41**



**DEBURRING TOOL POCKET CLIP**

- Handy pocket clip for added convenience

Item ID: **DET02**



**DEBURRING TOOL**

- Supplied with 2 HSS knife blades

ITEM ID:	Description
DET01	Deburring tool
DET01RK	2 spare blades





**CHAIN TYPE GRIP WRENCH 4" DIAMETER PIPE/TUBE**

Item ID: **9124**



**RIVET GUN FOR 2.4, 3.0, 3.2, 4.0, 4.8MM RIVETS**

ITEM ID:	Aluminium mm	Steel mm	Stainless	Length mm	Weight g
			Steel mm		
HR30R	2.4/3.0/3.2/ 4.0/4.8	2.4/3.0/3.2/ 4.0/4.8	2.4/3.0/3.2/ 4.0/4.8	270	560
HR30RRK-1	Service Kit - Replacement nose pieces				
HR30RRK-2	Service Kit - Jaw pusher assembly				



**RIVET GUN FOR 2.4, 3.2, 4.0, 4.8MM RIVETS**

ITEM ID:	Aluminium mm	Steel mm	Stainless	Length mm	Weight g
			Steel mm		
HR12	2.4/3.2/4.0/4.8	2.4/3.2/4.0/4.8	2.4/3.2/4.0	250	560
HR12RK	Spare parts set				



**SWIVEL HEAD RIVET GUN FOR 2.4, 3.0, 3.2, AND 4.0MM RIVETS**

ITEM ID:	Aluminium mm	Steel mm	Stainless	Length mm	Weight g
			Steel mm		
HR360R	2.4/3.0/3.2/ 4.0/4.8/5.0	2.4/3.0/ 3.2/4.0	2.4/3.0/3.2	295	712
HR12RK	Spare parts set				



**RIVET GUN FOR 2.4, 3.2, 4.0, 4.8MM RIVETS ALUMINIUM HANDLE**

ITEM ID:	Aluminium mm	Steel mm	Length mm	Weight g
HR01	2.4/3.2/4.0/4.8	2.4/3.2/4.0/4.8	250	560
HR01RK	Spare parts set			





**LAZY TONGUE RIVET GUN FOR 3.2, 4.0, 4.8, 6.0, 6.4MM RIVETS**

ITEM ID:	Description
HRLT01	Rivet Gun
HRLT01RK	Spare parts set



**NUTSERT GUN FOR M3, M4, M5, M6 NUTSERTS**

ITEM ID:	Aluminium mm	Length mm	Weight g
HN02	M3 x 0.5, M4 x 0.7, M5 x 0.8, M6 x 1.0	250	800



**LONG HANDLE RIVET GUN FOR 3.2, 4.0, 4.8, 6.0, 6.4MM RIVETS**

ITEM ID:	Description
HRLR01	Rivet Gun
HRLR01RK-2	Service Kit - Replacement nose pieces
HRLR01RK-3	Service Kit - Jaw pusher assembly



**LONG HANDLE NUTSERT GUN FOR M5, M6, M8, M10 NUTSERTS**

ITEM ID:	Aluminium mm	Length mm	Weight g
HRLN65N	M5, M6, M8, M10	530	1800
HRLN65NRK-1	Spare parts set		



**SCRIBER**

ITEM ID:	Length mm	Diameter mm
SCR01	135	7



**SCRIBER 150mm**

ITEM ID:	Length mm	Diameter mm
SCR02	150	6







**FLEXIBLE CLAW PICK UP TOOL 600mm LENGTH**

Item ID: **AT135**



**TELESCOPIC MAGNIFYING GLASS**

Item ID: **581TMG**

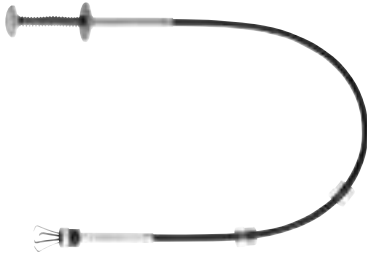

**FLEXIBLE MAGNETIC CLAW PICK UP TOOL 600mm LENGTH**

Item ID: **AT135M**



**TELESCOPIC INSPECTION MIRROR**

Item ID: **581TMI**



**TELESCOPIC MAGNETIC PICK UP**

Item ID: **581TMP**





**TELESCOPIC MAGNETIC PICK UP TOOL**

Item ID: **SD501**



**LED TORCH WITH POCKET CLIP**

Item ID: **585**



**TELESCOPIC 3 IN 1 INSPECTION TOOL**

Item ID: **582MI**



**TORCH POCKET CLIP**

- Pocket clip and pocket sized (132 mm length) for easy storage
- Requires 2 x AAA batteries (not included) for up to 13,5 hours usage

Item ID: **581N1**



**TELESCOPIC MAGNETIC PICK UP AND PEN**

Item ID: **585MP**





**HEAD LAMP HIGH OR LOW SETTINGS**

- Requires 3 AA batteries (not included)

Item ID: **586C**



**MAGNIFYING GLASS WITH 14 LED BULBS**

- Requires 2 AAA batteries (not included)

ITEM ID:	Magnification	Diameter mm	LED Output W	Lumens
587H	3	100	1.3	72



**FLEXIBLE LIGHT WITH MAGNET**

Specification:		
Total length	mm	595
Flexible length	mm	400
Outside diameter	mm	10
Maximum magnetic force	g	750

Item ID: **586**



**MAGNETIC LED LIGHT BAR**

- 255mm wide light bar with 9 built in white LED lights
- Requires 3 AA batteries (not included)

Item ID: **587J**





**MAGNETIC BRACELET**

Item ID: **583M**



**MAGNETIC BITS TRAY OBLONG LARGE DEEP**

Item ID: **580A**



**MAGNETIC BITS TRAY ROUND 6"**

Item ID: **580**



**PLASTIC MAGNETIC BITS TRAY ROUND**

ITEM ID:	Diameter mm	Weight g
580Q	112	191
580R	150	400



**MAGNETIC BITS TRAY SQUARE EXTRA LARGE**

Item ID: **580S**





### MAGNETIC HOLDERS

ITEM ID:	Holding Area mm	Max Width mm	Height mm	Magnetic Force kg
MH75	75	120	82	30
MH90	90	160	100	30



### QUICK ACTION TOP LEVER CLAMP

ITEM ID:	Clamping Force N	Span Width mm	Clamping Capacity mm	Weight g
CMQ150	1580	85	150	580
CMQ300	1580	85	300	680
CMQ450	1580	85	450	790
CMQ600	1580	85	600	890



### SCREW CLAMP

ITEM ID:	Clamping Force N	Span Width mm	Throat Depth mm	Bar Dimension mm	Weight g
CMD12	1961	120	60	20.0 x 5.0	430
CMD16	2648	160	80	25.0 x 6.0	750
CMD20	3922	200	100	27.0 x 7.0	1120
CMD25	4903	250	120	29.0 x 9.0	1500
CMD30A	5393	300	140	32.0 x 10.0	2050
CMD40	5393	400	140	32.0 x 10.0	2260
CMD40A	5393	400	175	32.0 x 10.0	2330
CMD80	4903	800	120	29.0 x 9.0	2480



### QUICK ACTION BOTTOM LEVER CLAMP

ITEM ID:	Clamping Force N	Span Width mm	Clamping Capacity mm	Weight g
CMQL150	1780	80	150	670
CMQL300	1780	80	300	780
CMQL450	1780	80	450	900



**F TYPE CLAMP SWIVEL HANDLE**

ITEM ID:	Clamping Force N	Span Width mm	Throat Depth mm	Weight g
CMF16T	160	80	16.5x7.5	570
CMF20T	200	100	19.5x9.5	1010
CMF25T	250	120	22x10.5	1330
CMF30T	300	140	25x12	1960
CMF35T	300	100	25x12	1140



**F TYPE CLAMP FIXED HANDLE**

ITEM ID:	Clamping Force N	Span Width mm	Throat Depth mm	Weight g
CMF16	160	80	16.5x7.5	480
CMF20	200	100	19.5x9.5	900
CMF25	250	120	22x10.5	1210
CMF30	300	140	25x12	1800
CMF35	300	120	25x12	1720



**RATCHET ACTION F CLAMP**

ITEM ID:	Clamping Force N	Span Width mm	Throat Depth mm	Bar Dimension mm	Weight g
CMFQ20	3432	200	100	19.5 x 9.5	1130
CMFQ25	3922	250	120	22.0 x 10.5	1500
CMFQ40	5393	400	120	25.0 x 12.0	2400



**4 INCH WORK BENCH VICE**

- Forged steel 4" (100mm)

Item ID: **TCAV4**



**WRENCH DOOR HINGE**

ITEM ID:	Length mm	Diameter mm	Weight g
DHW1300	220	13	170
DHW1417	290	14 x 17	310
DHW1922	300	19 x 22	440

**BALL PEIN HAMMER**

ITEM ID:	Head Weight oz	Overall Weight g	Head Diameter mm	Overall Length mm
HMBP12	12	550	28	280
HMBP16	16	600	30	320
HMBP24	24	1040	35	380
HMBP32	32	1280	39	380

**ENGINEERS HAMMER**

ITEM ID:	Head Weight g	Overall Weight g	Head Diameter mm
HMEG300	300	420	300
HMEG500	500	650	320
HMEG800	800	1000	350

**CLUB TYPE LUMP HAMMER**

ITEM ID:	Head Weight g	Overall Weight g	Head Diameter mm	Overall Length mm
HMS1250	1250	1609	43	296

**CARPENTERS CLAW HAMMER**

ITEM ID:	Head Weight oz	Overall Weight g	Head Diameter mm	Overall Length mm
HMCH08A	8	394	21.6	290
HMCH13A	13	552	27	335
HMCH16A	16	700	27	312







**CARPENTERS SHOCK ABSORBENT CLAW HAMMER 16OZ**

ITEM ID:	Head Weight oz	Overall Weight g	Head Diameter mm	Overall Length mm
HMCHM16	16	723	29	333



**SOFT FACE HAMMER**

ITEM ID:	Weight g	Length mm
HMSF	670	320



**CARPENTERS MAGNETIC CLAW HAMMER 16OZ**

ITEM ID:	Head Weight oz	Overall Weight g	Head Diameter mm	Overall Length mm
HMCH16M	16	678	27.5	341



**DEADBLOW POLYURETHANE HAMMER**

ITEM ID:	Face Diameter mm	Weight g
HMDH50PU	50	711
HMDH60PU	60	1168
HMDH70PU	70	1600



**DEAD BLOW HAMMER**

ITEM ID:	Face Diameter mm	Weight g
HMDH35	35	300
HMDH45	45	490
HMDH55	55	980
HMDH65	65	1365



**PARALLEL PIN PUNCH**

ITEM ID:	Size mm	Length mm
PP03	3	150
PP04	4	150
PP05	5	150
PP06	6	150
PP07	7	150
PP08	8	150

**CENTRE PUNCH**

ITEM ID:	Size mm	Length mm
CP04	4	150
CP05	5	150
CP08	8	150

**AUTOMATIC CENTRE PUNCH**

- 1mm diameter tip

Item ID: **SCP01****FLAT COLD CHISEL**

ITEM ID:	Size mm	Length mm
CC150F	18	150
CC200F	25	200
CC250F	25	250
CC240F	26	240





### PARALLEL PIN PUNCH SET 6 PIECES

- Parallel Pin Punch
- 3, 4, 5, 6, 7, 8

Item ID: **PPS06**



### CHISEL HAND PROTECTION GRIP

- For use with TengTools 200, 240 and 250mm cold chisels

Item ID: **PCCAP**



### PUNCH AND CHISEL SET 5 PIECES

- Parallel Pin Punch
- 3, 4, 5
- Centre Punch 5mm
- Flat Cold Chisel 150 x 18mm

Item ID: **PCX05**



### SAFETY HARNESS 1.6m MAXIMUM LENGTH

- Stretches from 430mm to 1.6 meters

Item ID: **SSH01**





**SAFETY HARNESS SWIVEL HOOKS  
1.35M MAXIMUM LENGTH**

Item ID: **SSH02**



**SAFETY HARNESS SPRING HOOKS  
1.35M MAXIMUM LENGTH**

Item ID: **SSH03**



**SAFETY HARNESS SPRING HOOK/ROPE LOCK  
1.45M MAXIMUM LENGTH**

Item ID: **SSH04**

Lens Colour	CE Code	Visible Light 380-780nm	General Features
Clear	2-1.2 2C-1.2	90% (UV380)	<ul style="list-style-type: none"> <li>General purpose that provides maximum visibility.</li> <li>Indoor lens, good for mechanical work, or dusk, dawn and night time activities.</li> <li>For shooting indoors when no contrast is needed. An excellent safety lens while hand loading.</li> </ul>
Amber	2-1.2	90% (UV380)	<ul style="list-style-type: none"> <li>Maximum enhancement of contrast in low light environments i.e. warehouse.</li> <li>Blocks out 87% of blue light with unparalleled level of detail definition &amp; colour recognition.</li> <li>Offers brighter view in early morning or late evening, on cloudy, foggy, or hazy days.</li> <li>Suitable for night shift workers, surface inspection and mechanical work.</li> <li>Recommended for shooting and indoor target sports.</li> </ul>
Smoke	5-2.5	18% (UV380)	<ul style="list-style-type: none"> <li>Transmits all colours at the same level.</li> <li>Protects eyes from excessive glare and high levels of hazardous visible light and ultraviolet radiation without distorting colour perception.</li> <li>Ideal for outdoors, for use on bright days &amp; bright sunlight, but does not enhance target.</li> <li>General purpose safety lens / the most popular tinted lens.</li> </ul>



**SAFETY GLASSES CLEAR ANTI FOG LENS**

ITEM ID:	Lens	Scratch Resistant	Anti Fog
SC960	Clear	Y	Y





**SAFETY GLASSES GREY LENS**

ITEM ID:	Lens	Scratch Resistant	Anti Fog
SG960G	Grey/Smoke	Y	Y



**SAFETY GLASSES CLEAR LENS**

ITEM ID:	Lens	Scratch Resistant	Anti Fog
SG960A	Clear	Y	-



**SAFETY GLASSES YELLOW LENS**

ITEM ID:	Lens	Scratch Resistant	Anti Fog
SG960Y	Amber	Y	Y



**SAFETY GLASSES CLEAR LENS SPORT STYLE**

ITEM ID:	Lens	Scratch Resistant	Anti Fog
SG713	Clear	Y	Y





### SAFETY GLASSES GREY LENS SPORT STYLE



ITEM ID:	Lens	Scratch Resistant	Anti Fog
SG713G	Grey/Smoke	Y	Y



### TENG COLLECTION BLACK FRAME PROTECTIVE SUN GLASSES



ITEM ID:	Style	Arm Type
P-SG02	Black/Grey Frames	Straight



### TENG COLLECTION RED FRAME PROTECTIVE SUN GLASSES



ITEM ID:	Style	Arm Type
P-SG01	Red Frames	Straight



### TENG COLLECTION MIRROR LENS PROTECTIVE SUN GLASSES

ITEM ID:	Style	Arm Type
P-SG03	Black Frames	Curved



# AIR TOOLS

## ESSENTIAL FOR ANY WORKSHOP

Air is a powerful and versatile resource that can help you get the job done quickly! If you need to cut through steel or machine-tighten a bolt, you will need a certain amount of torque. Choosing a tool for its convenience or cost really won't do any good if it isn't strong enough to get the job done. This range of air tools pack a real punch and have been developed to exceed the demands of a professional auto workshop.









### AIR RATCHET 3/8" DRIVE

3/8"

SPECIFICATION:		
Square drive	inch	3/8"
Bolt capacity	mm	M10
Free speed	rpm	220
Forward/reverse torque	Nm	41
Forward/reverse torque	ft-lb	30
Sound level *	dB	88
Vibration **	m/s <sup>2</sup>	10
Minimum hose size	inch	3/8"
Air inlet	inch	1/4"
Air consumption at 100% int.	l/min	90.6
Air consumption at 100% int.	cfm	3.2
Air consumption at 15% int.	l/min	14
Air consumption at 15% int.	cfm	0.5
Length	mm	173.9
Weight	kg	0.6

\* A weighted sound pressure level at work station in accordance with EN ISO 15744

\*\* Vibration value according to EN ISO 28927-2

Item ID: **ARRM38**



### 1/2" DRIVE MINI AIR IMPACT WRENCH

1/2"

SPECIFICATION:		
Square drive	inch	1/2"
Bolt capacity	mm	M16
Free speed	rpm	8,000
Max torque (3 steps)	Nm	285/380/680
Max torque (3 steps)	ft-lb	210/280/501
Max reverse torque	Nm	770
Max reverse torque	ft-lb	568
Hammer mechanism	type	Jumbo hammer
Sound level *	dB	102
Vibration **	m/s <sup>2</sup>	7.5
Minimum hose size	inch	3/8"
Air inlet	inch	1/4"
Air consumption at 100% int.	l/min	121
Air consumption at 100% int.	cfm	4.23
Air consumption at 15% int.	l/min	18
Air consumption at 15% int.	cfm	0.6
Length	mm	113
Weight	kg	1.3

\* A weighted sound pressure level at work station in accordance with EN ISO 15744

\*\* Vibration value according to EN ISO 28927-2

Item ID: **ARWM12M**





### 3/8" DRIVE AIR IMPACT WRENCH

3/8"

SPECIFICATION:		
Square drive	inch	3/8"
Bolt capacity	mm	M13
Free speed	rpm	9,000
Max torque (3 steps)	Nm	115/285/465
Max torque (3 steps)	ft-lb	85/210/342
Max reverse torque	Nm	490
Max reverse torque	ft-lb	361
Hammer mechanism	type	Twin hammer
Sound level *	dB	95.4
Vibration **	m/s <sup>2</sup>	4.96
Minimum hose size	inch	3/8"
Air inlet	inch	1/4"
Air consumption at 100% int.	l/min	105
Air consumption at 100% int.	cfm	3.7
Air consumption at 15% int.	l/min	16
Air consumption at 15% int.	cfm	0.6
Length	mm	159.4
Weight	kg	1.5

\* A weighted sound pressure level at work station in accordance with EN ISO 15744

\*\* Vibration value according to EN ISO 28927-2

Item ID: **ARWM38**



### 3/8" DRIVE COMPOSITE AIR IMPACT WRENCH

3/8"

SPECIFICATION:		
Square drive	inch	3/8"
Bolt capacity	mm	M13
Free speed	rpm	9,000
Max torque (3 steps)	Nm	163/244/450
Max torque (3 steps)	ft-lb	120/180/331
Max reverse torque	Nm	470
Max reverse torque	ft-lb	346
Hammer mechanism	type	Twin hammer
Sound level *	dB	94
Vibration **	m/s <sup>2</sup>	3.8
Minimum hose size	inch	3/8"
Air inlet	inch	1/4"
Air consumption at 100% int.	l/min	128
Air consumption at 100% int.	cfm	4.5
Air consumption at 15% int.	l/min	19
Air consumption at 15% int.	cfm	0.7
Length	mm	161
Weight	kg	1.3

\* A weighted sound pressure level at work station in accordance with EN ISO 15744

\*\* Vibration value according to EN ISO 28927-2

Item ID: **ARWC38**





### 1/2" DRIVE COMPOSITE AIR IMPACT WRENCH

1/2"

SPECIFICATION:		
Square drive	inch	1/2"
Bolt capacity	mm	M16
Free speed	rpm	6,800
Max torque (3 steps)	Nm	258/461/930
Max torque (3 steps)	ft-lb	190/340/685
Max reverse torque	Nm	960
Max reverse torque	ft-lb	708
Hammer mechanism	type	Twin hammer
Sound level *	dB	96
Vibration **	m/s <sup>2</sup>	3.6
Minimum hose size	inch	3/8"
Air inlet	inch	1/4"
Air consumption at 100% int.	l/min	144
Air consumption at 100% int.	cfm	5.1
Air consumption at 15% int.	l/min	22
Air consumption at 15% int.	cfm	0.8
Length	mm	186
Weight	kg	2

\* A weighted sound pressure level at work station in accordance with EN ISO 15744

\*\* Vibration value according to EN ISO 28927-2

Item ID: **ARWC12**



### 3/4" DRIVE COMPOSITE AIR IMPACT WRENCH

3/4"

SPECIFICATION:		
Square drive	inch	3/4"
Bolt capacity	mm	M32
Free speed	rpm	6,000
Max torque (3 steps)	Nm	1,084/1,300/1,790
Max torque (3 steps)	ft-lb	800/960/1,320
Max reverse torque	Nm	1,830
Max reverse torque	ft-lb	1,349
Hammer mechanism	type	Twin hammer
Sound level *	dB	100
Vibration **	m/s <sup>2</sup>	19
Minimum hose size	inch	1/2"
Air inlet	inch	3/8"
Air consumption at 100% int.	l/min	195
Air consumption at 100% int.	cfm	6.9
Air consumption at 15% int.	l/min	29
Air consumption at 15% int.	cfm	1
Length	mm	218.8
Weight	kg	3.5

\* A weighted sound pressure level at work station in accordance with EN ISO 15744

\*\* Vibration value according to EN ISO 28927-2

Item ID: **ARWC34**

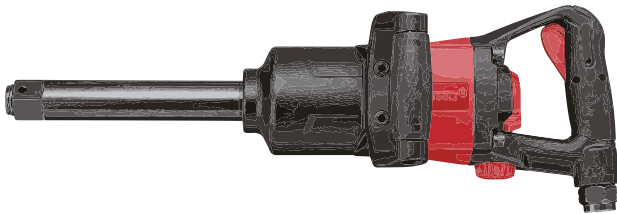

**1" DRIVE STARIGHT AIR IMPACT WRENCH**

1

SPECIFICATION:		
Square drive	inch	1"
Bolt capacity	mm	M36
Free speed	rpm	5,500
Max torque (4 steps)	Nm	976/1,300/1,735/2,712
Max torque (4 steps)	ft-lb	720/960/1,280/2,000
Max reverse torque	Nm	2,730
Max reverse torque	ft-lb	2,013
Hammer mechanism	type	Twin hammer
Sound level *	dB	105
Vibration **	m/s <sup>2</sup>	12.88
Minimum hose size	inch	3/4"
Air inlet	inch	1/2"
Air consumption at 100% int.	l/min	271
Air consumption at 100% int.	cfm	9.6
Air consumption at 15% int.	l/min	41
Air consumption at 15% int.	cfm	1.4
Length	mm	504.5
Weight	kg	8.1

\* A weighted sound pressure level at work station in accordance with EN ISO 15744

\*\* Vibration value according to EN ISO 28927-2

Item ID: **ARWM11S****AIR DRILL 10MM CHUCK**

SPECIFICATION:		
Chuck size	mm	10
Free speed	rpm	1,800
Minimum hose size	inch	3/8"
Air inlet	inch	1/4"
Sound level *	dB	88
Vibration **	m/s <sup>2</sup>	3
Air consumption at 100% int.	l/min	121
Air consumption at 100% int.	cfm	4
Air consumption at 15% int.	l/min	18
Air consumption at 15% int.	cfm	0.7
Length	mm	206.2
Weight	kg	1.2

\* A weighted sound pressure level at work station in accordance with EN ISO 15744

\*\* Vibration value according to EN ISO 28927-2

Item ID: **ARD10**



### AIR DRILL 13MM CHUCK

SPECIFICATION:		
Chuck size	mm	13
Free speed	rpm	450
Minimum hose size	inch	3/8"
Air inlet	inch	1/4"
Sound level *	dB	89
Vibration **	m/s <sup>2</sup>	2
Air consumption at 100% int.	l/min	140
Air consumption at 100% int.	cfm	5
Air consumption at 15% int.	l/min	21
Air consumption at 15% int.	cfm	0.8
Length	mm	249.5
Weight	kg	1.9

\* A weighted sound pressure level at work station in accordance with EN ISO 15744

\*\* Vibration value according to EN ISO 28927-2

Item ID: **ARD13**



### AIR SAW

SPECIFICATION:		
Stroke length	mm	10
Strokes per minute	bpm	9,000
Cutting capacity – steel	mm	3
Cutting capacity – aluminium	mm	3
Cutting capacity – wood	mm	4
Sound level *	dB	84
Vibration **	m/s <sup>2</sup>	<2.4
Minimum hose size	inch	3/8"
Air inlet	inch	1/4"
Air consumption at 100% int.	l/min	31
Air consumption at 100% int.	cfm	1.08
Air consumption at 15% int.	l/min	4.7
Air consumption at 15% int.	cfm	0.2
Length	mm	245.1
Weight	kg	0.7

\* A weighted sound pressure level at work station in accordance with EN ISO 15744

\*\* Vibration value according to EN ISO 28927-2

Item ID: **ARS01**



### AIR SAW

SPECIFICATION:		
Stroke length	mm	10
Strokes per minute	bpm	9,000
Cutting capacity – steel	mm	3
Cutting capacity – aluminium	mm	3.4
Cutting capacity – wood	mm	4
Sound level *	dB	84.4
Vibration **	m/s <sup>2</sup>	5.26
Minimum hose size	inch	3/8"
Air inlet	inch	1/4"
Air consumption at 100% int.	l/min	22.94
Air consumption at 100% int.	cfm	0.81
Air consumption at 40% int.	l/min	9.18
Air consumption at 40% int.	cfm	0.32
Length	mm	170
Weight	kg	0.45

\* A weighted sound pressure level at work station in accordance with EN ISO 15744

\*\* Vibration value according to EN ISO 28927-2

Item ID: **ARS02**



### AIR CUT OFF TOOL

SPECIFICATION:		
For cutting discs	mm	76x10mm, 3"x3/8"
Speed	rpm	18,000
Sound Level *	dB	98
Vibration **	m/s <sup>2</sup>	2.3
Minimum hose size	inch	3/8"
Connection thread	inch	1/4"
Air consumption at 100% int.	l/min	113
Air consumption at 100% int.	cfm	4
Air consumption at 40% int.	l/min	45
Air consumption at 40% int.	cfm	1.6
Weight	kg	0.9

\* A weighted sound pressure level at work station in accordance with EN ISO 15744

\*\* Vibration value according to EN ISO 28927-2

Item ID: **ARC80**







### AIR DIE GRINDER STRAIGHT

SPECIFICATION:		
Angle		Straight
Collet	mm	6
Free speed	rpm	25,000
Sound level *	dB(A)	82
Vibration **	m/s <sup>2</sup>	5
Minimum hose size	inch	3/8
Air inlet	inch	1/4
Air consumption at 100% int.	l/min	113
Air consumption at 15% int.	l/min	17
Air consumption at 100% int.	cfm	4
Air consumption at 15% int.	cfm	0.6
Length	mm	161
Weight	g	400

\* A weighted sound pressure level at work station in accordance with EN ISO 15744

\*\* Vibration value according to EN ISO 28927-2

Item ID: **ARG01**



### AIR BELT SANDER

SPECIFICATION:		
For sanding belt	mm	6 x 330, 10 x 330
Free speed	rpm	20,000
Sound pressure level *	dB	86
Sound power level	dB	97
Vibration **	m/s <sup>2</sup>	1
Measurement uncertainty (Standard)	m/s <sup>2</sup>	1
Min. hose size	inch	3/8"
Air inlet	inch	1/4"
Air consumption at 100% int.	l/min	119
Air consumption at 50% int.	l/min	59.5
Air consumption at 100% int.	cfm	4.2
Air consumption at 50% int.	cfm	2.1
Length	mm	331
Weight	kg	0.85

\* A weighted sound pressure level at work station in accordance with EN ISO 15744

\*\* Vibration value according to EN ISO 28927-2

Item ID: **ARBS10**



### AIR NEEDLE SCALER

SPECIFICATION:		
Stroke speed	bpm	4,000
No. of needles	pcs	12
Needle stroke	mm	24
Needle diameter x length (AXB)	mm	3 x 126
Sound pressure level *	dB	88.7
Vibration **	m/s <sup>2</sup>	3.8
Min. hose size	inch	3/8"
Air inlet	inch	1/4"
Air consumption at 100% int.	l/min	170
Air consumption at 20% int.	l/min	34
Air consumption at 100% int.	cfm	6
Air consumption at 20% int.	cfm	1.2
Total length	mm	310
Weight	kg	1,14

\* A weighted sound pressure level at work station in accordance with EN ISO 15744

\*\* Vibration value according to EN ISO 28927-2

Item ID: **ARN12**



### AIR RIVET GUN

SPECIFICATION:		
Traction force	N	9,000
Compressed air pressure stroke	mm	16
Sound pressure level *	dB	86
Sound power level	dB	97
Vibration **	m/s <sup>2</sup>	3
Air inlet	inch	1/4" PT-19
Min. hose size	inch	3/8"
Working Temperature	°C	0-40
Air consumption at 100% int.	l/rivet	2.1
Weight	g	1710

\* A weighted sound pressure level at work station in accordance with EN ISO 15744

\*\* Vibration value according to EN ISO 28927-2

Item ID: **ARRG80**





### AIR ENGRAVING PEN

SPECIFICATION:		
Working pressure	bar	6
Stroke speed	bpm	13,000
Sound Level *	dB	78
Sound power level	dB	90
Vibration **	m/s <sup>2</sup>	3
Air inlet	inch	1/4"
Air consumption at 100% int.	l/min	30
Air consumption at 50% int.	l/min	15
Air consumption at 100% int.	cfm	1.1
Air consumption at 50% int.	cfm	0.6
Weight	kg	0.22

\* A weighted sound pressure level at work station in accordance with EN ISO 15744

\*\* Vibration value according to EN ISO 28927-2

Item ID: **AREP25**



### AIR BLOW GUN 127mm

SPECIFICATION:		
Nozzle length	mm	100
Air inlet	inch	1/4"
Length	mm	212
Weight	g	106

Item ID: **ARB01**



### AIR BLOW GUN 300mm

SPECIFICATION:		
Nozzle length	mm	270
Air inlet	inch	1/4"
Length	mm	360
Weight	g	130

Item ID: **ARB02**



### AIR BLOW GUN 100mm

SPECIFICATION:		
Nozzle length	mm	100
Air inlet	inch	1/4"
Length	mm	212
Weight	g	160

Item ID: **ARB03**



Item ID	PAGE	Item ID	PAGE	Item ID	PAGE	Item ID	PAGE
1101	259	1292P418-CT	308	1492P015	302	220827	363
1192P1000	307	1292P912	308	1492P015RKC	308	220830	363
1192P1000RK	308	1292P912-CT	308	1492P030	302	220840	363
1192P1500	307	1400-72MN	254	1492TSD	302	220845	363
1192P1500RK	308	1400-72N	255	1492TSD-CT	302	220850	363
1192P2000	307	1400-72NRK	257	1492TVSD	302	220855	363
1200-45E	256	1400-72SN	255	1492TVSD-CT	302	220860	363
1200-72N	255	1400-72U	255	1498TPX	396	220870	363
1200-72NRK	257	1400-72URK	257	1499AF	390	2300	476
1200-72SN	255	1400B	369	1499MM	389	2912512	343
1200-72U	255	1400F	256	1499MML	389	2912513	343
1200-72URK	257	1400FRK	257	1499TX	394	2912514	343
1200F	256	1400FRP	255	210705	365	2912520	343
1200FRK	257	1400FRPRK	257	210706	365	2912535	343
1200FRP	255	1400L	256	210707	365	2912537	343
1200FRPRK	257	1400M	254	210708	365	2912539	343
1200L	256	1424	392	210709	365	310102	382
1201	259	1425	392	210710	365	3101025	382
1201A	259	1471AF	391	210712	365	3101025BL	385
1201ARK	259	1471AFA	391	210714	365	310103	382
1202	467	1471MM	390	210717	365	3101035	382
1202A	467	1471MMA	391	210719	365	310103BL	385
120955-C	280	1473	396	210805	365	310104	382
1292AG4-CT	304	1474	389	210806	365	3101045	382
1292AG4R-CT	304	1475	388	210807	365	310104BL	385
1292AG4RK	308	1476NAF	391	210808	365	310105	382
1292AG4RRK	308	1476NMM	390	210809	365	310105BL	385
1292AG-E4	304	1476NMM1	390	210810	365	310106	382
1292AG-E4R	304	1476NTX	395	210812	365	310106BL	385
1292AG-EP	304	1476NTX1	395	210814	365	310107	382
1292AG-ER	304	1476NTX2	395	210817	365	310107BL	385
1292AGERK	308	1477AF	387	210819	365	310108	382
1292AGERRK	308	1477MM	387	220708	363	310108BL	385
1292AGP-CT	304	1477NX	396	220710	363	310110	382
1292AGR-CT	304	1479AF	389	220715	363	310110BL	385
1292CQ200R	308	1479MM	388	220720	363	310112	382
1292D200	306	1479MMA	388	220725	363	310112BL	385
1292D200-CT	306	1479MMR	387	220727	363	310114	382
1292P100	306	1479MMRL	388	220730	363	310116	382
1292P100-CT	306	1479TX	394	220740	363	310120	382
1292P100RK-1	308	1479TX1	394	220745	363	3105007	382
1292P200	306	1486	369	220750	363	3105009	382
1292P200-CT	306	1487	395	220755	363	3105013	382
1292P200RK-1	308	1488	369	220760	363	3105015	382
1292P320	306	1492AG-CT	302	220770	363	3105015BL-C	383
1292P320-CT	306	1492AG-E	302	220820	363	310502	382
1292P418	308	1492AGERK	308	220825	363	3105025	382



Item ID	PAGE	Item ID	PAGE	Item ID	PAGE	Item ID	PAGE
3105025BL-C	383	320027BL	393	3892AG1-CT	303	390820TPX	396
310502BL-C	383	320030	392	3892AG1RK	308	390825TPX	396
310503	382	320030BL	393	3892AG3-CT	303	390827TPX	396
310503BL-C	383	320040	392	3892AG3RK	308	390830TPX	396
310504	382	320040BL	393	3892AG-E1	303	390840TPX	396
3105045	382	320045	392	3892AG-E3	303	390908BL	393
310504BL-C	383	320045BL	393	3892CQ100R	308	390909BL	393
310505	382	320050	392	3892D100	303	390910BL	393
3105055	382	320050BL	393	3892D100-CT	303	390915BL	393
310505BL-C	383	3205015	383	3892P030	304	390920BL	393
310506	382	320502	383	3892P030RK	308	390925BL	393
310506BL-C	383	3205025	383	3892P060	304	390927BL	393
310507	382	320503	383	3892P060-CT	304	390930BL	393
310507BL-C	383	320504	383	3892P060RK-1	308	390940BL	393
310508	382	320505	383	3892P100	304	4001	338
310508BL-C	383	320506	383	3892P100-CT	304	4002	338
310509	382	320508	383	3901025BL	385	4002IQ	338
310510	382	320510	383	390103BL	385	4002WT	339
310510BL-C	383	3401	259	390104BL	385	4003	338
310511	382	3492AG1-CT	307	390105BL	385	4003IQ	338
310512	382	3492AG2-CT	307	390106BL	385	4003J	339
310512BL-C	383	3492AG-CT	307	390107BL	385	4003WT	339
310514	382	3492AG-E	307	390108BL	385	4004	338
310514BL-C	383	3492AG-E1	307	390110BL	385	4004IQ	338
310516	382	3492AG-E2	307	390112BL	385	4004WT	339
310517	382	3492AG-ER	307	3905015BL	384	4005	338
310517BL-C	383	3492AGERK	308	3905025BL	384	4005IQ	338
310518	382	3492AGERRK	308	390502BL	384	4005WT	339
310519	382	3492AGR-CT	307	390503BL	384	4006	338
310519BL-C	383	3492CQ500R	308	390504BL	384	4006IQ	338
310522	382	3492P1000	307	390505BL	384	4007	338
310527	382	3492P500	307	390506BL	384	4008	338
310532	382	3492P500-CT	307	390508BL	384	401-10	415
310536	382	3492P500RK-1	308	390510BL	384	401-10F	415
320008	392	3800-41E	256	3908015BL	384	401-12	415
320008BL	393	3800-41ERK	257	3908020BL	384	401-12F	415
320009	392	3800-72MN	255	3908025BL	384	401-4	415
320009BL	393	3800-72N	255	390803BL	384	401-5	415
320010	392	3800-72NRK	257	390804BL	384	401-7	415
320010BL	393	3800-72SN	255	390805BL	384	402	416
320015	392	3800-72U	255	390806BL	384	404-4	416
320015BL	393	3800-72URK	257	390808BL	384	404-6	416
320020	392	3800F	256	390808TPX	396	404-6S	416
320020BL	393	3800FRK	257	390809TPX	396	404-9	416
320025	392	3800FRP	255	390810BL	384	406	416
320025BL	393	3800FRPRK	257	390810TPX	396	406-6	416
320027	392	3800L	256	390815TPX	396	406-6P	417



Item ID	PAGE	Item ID	PAGE	Item ID	PAGE	Item ID	PAGE
406-6S	417	510510	386	600	330	600510	316
406-6SP	417	510512	386	600108	317	600510R	324
406P	417	5106025	386	600110	317	600510RF	327
406S	417	510603	386	600110R	325	600510RS	326
406SP	417	510604	386	600112	317	600511	316
407	418	510605	386	600112R	325	600511R	324
407AS	418	510606	386	600114	317	600511RF	327
408	418	510607	386	600114R	325	600511RS	326
409	464	510608	386	600116	317	600512	316
409P	419	520009	394	600116R	325	60051215RX	333
409SP	419	520010	394	600118	317	600512R	324
410P	419	520015	394	600118R	325	600512RF	327
410SP	419	520020	394	600120	317	600512RS	326
418S	417	520025	394	600120R	325	600513	316
418SP	418	520027	394	600122	317	600513R	324
445W	408	520030	394	600122R	325	600513RF	327
480	415	520040	394	600124	317	600513RS	326
490	434	520045	394	600124R	325	600514	316
490W	435	520050	394	600126	317	600514R	324
491	434	520055	394	600126R	325	600514RF	327
491-7N	436	580	486	600128	317	600514RS	326
491W	435	580A	486	600128R	325	600515	316
492	434	580C	206	600130	317	600515R	324
492W	437	580CK	206	600132	317	600515RF	327
493	434	580CM	206	600134	317	600515RS	326
493-7N	436	580CN	206	600136	317	600516	316
494	435	580D	206	600140	317	60051619RX	333
494-7N	436	580J	206	600142	317	600516R	324
495	435	580K	206	600144	317	600516RF	327
496	401	580M	206	600146	317	600516RS	326
497	437	580N	206	600148	317	600517	316
498-7N	403	580Q	486	600152	317	600517R	324
510103	387	580R	486	600156	317	600517RF	327
510104	387	580S	486	600160	317	600517RS	326
510105	387	580T	208	6005055	316	600518	316
510106	387	581N1	484	600506	316	600518R	324
510107	387	581TMC	483	600507	316	600518RF	327
510108	387	581TMI	483	600507RF	327	600518RS	326
510110	387	581TMP	483	600508	316	600519	316
510502	386	582MI	484	60050811RX	333	600519R	324
5105025	386	583M	486	600508R	324	600519RF	327
510503	386	585	484	600508RF	327	600519RS	326
510504	386	585MP	484	600508RS	326	600520	316
510505	386	586	485	600509	316	600520RS	326
510506	386	586C	485	600509R	324	600521	316
510507	386	587H	485	600509RF	327	600521RS	326
510508	386	587J	485	600509RS	326	600522	316





Item ID	PAGE	Item ID	PAGE	Item ID	PAGE	Item ID	PAGE
600522R	324	6005M19RS	327	631011	328	651819	332
600522RS	326	600813	335	6311	329	6521	318
600523	316	600814	335	631113FL	329	6526MM	319
600524	316	600816	335	631213	328	6607AF	332
600524R	324	600817	335	631214FL	329	661416	333
600524RS	326	600819	335	631415	328	663032	331
600525	316	600822	335	631617	328	663436	331
600526	316	600824	335	631618FL	329	663840	331
600527	316	600827	335	631719FL	329	664244	331
600527R	324	600830	335	631819	328	664648	331
600528	316	600832	335	632022	328	665052	331
600529	316	601013	329	632123	328	665456	331
600530	316	605908	323	632224FL	329	6707AF	330
600530R	324	605909	323	632427	328	673032	328
600532	316	605910	323	633032	328	673436	328
600532R	324	605911	323	641011	333	673840	328
600533	316	605912	323	641213	333	674244	328
600534	316	605913	323	641314	333	674648	328
600536	316	605914	323	641617	333	675052	328
600538	316	605915	323	641922	333	675456	328
600541	316	605916	323	6503RX	333	680608	334
600546	316	605917	323	6507AF	320	680709	334
600550	316	605918	323	6507JAF	320	680810E	334
600555	316	605919	323	6507JMM	320	681013	334
600558	316	6059LMP	323	6507JMMA	321	681112E	334
600560	316	611214	332	650809	332	681214	334
600565	316	611618	332	6508RMM	325	681416E	334
600570	316	612022	332	6508RSMM	326	681719	334
6005M10	323	620607	330	6509AF	320	681820E	334
6005M10RS	327	6208	331	651011	332	682122	334
6005M11	323	620809	330	651013	332	682224E	334
6005M11RS	327	621011	330	6510A	321	690510	308
6005M12	323	6211	331	6510MM	318	690511	308
6005M12RS	327	6211MM	331	6510RMM	325	690512	308
6005M13	323	621213	330	6512	317	690513	308
6005M13RS	327	621415	330	651213	332	690514	308
6005M14	323	621617	330	6512MM	319	690515	308
6005M14RS	327	621819	330	6512MM1	318	690516	308
6005M15	323	622022	330	6512MMA	321	690517	308
6005M15RS	327	622123	330	6512N	317	690518	308
6005M16	323	622427	330	6512RSMM	326	690519	308
6005M16RS	327	623032	330	651415	332	690613	309
6005M17	323	630607	328	6515MM	319	690614	309
6005M17RS	327	6308	329	6515MMA	321	690615	309
6005M18	323	630809	328	651617	332	690616	309
6005M18RS	327	630810FL	329	6517	318	690617	309
6005M19	323	6308MM	330	6517MM	319	690618	309



Item ID	PAGE	Item ID	PAGE	Item ID	PAGE	Item ID	PAGE
690619	309	690842	310	800619	322	910524	296
690621	309	690844	310	8512A	322	910527	296
690622	309	690846	310	8512MM	322	910530	296
690624	309	691406	332	902024	336	910532	296
690626	309	700-PRO5	438	902027	336	910533	296
690627	309	701	439	902030	336	910534	296
690629	309	701N	439	902032	336	910536	296
690630	309	701NI	439	902036	336	910538	296
690632	309	702	439	902038	336	910541	296
690634	309	703A	439	902041	336	910546	296
690636	309	703A-10	439	902046	336	910550	296
690638	309	703A-24	439	902050	336	910555	296
690640	309	704	440	902055	336	910560	296
690641	309	705	440	902060	336	910565	296
690642	309	705-5	440	902065	336	910570	296
690644	309	705A	440	902070	336	910575	296
690646	309	705A-5	440	902075	336	910580	296
690710	309	710	445	902080	336	910585	296
690711	309	710-10	446	902085	336	910590	296
690712	309	710-100	446	902090	336	910595	296
690713	309	710-100H	446	902095	336	910624	297
690714	309	710-10H	446	902100	336	910627	297
690715	309	710A	443	903024	336	910627R	297
690716	309	710A-10	444	903027	336	910628	297
690717	309	710A-100	444	903030	336	910630	297
690718	309	710C	444	903032	336	910630R	297
690719	309	710F	444	903036	336	910632	297
690813	310	710F-10	444	903038	336	910632R	297
690814	310	710F-100	444	903041	336	910633	297
690815	310	710G	444	903046	336	910633R	297
690816	310	710H	444	903050	336	910636	297
690817	310	710N	446	903055	336	910732	297
690818	310	710S	443	903060	336	9110	464
690819	310	710U-10	445	903065	336	9110RK-1	464
690821	310	711	445	903070	336	9113	251
690822	310	712	445	903075	336	9117	251
690824	310	800608	322	903080	336	9120	464
690826	310	800609	322	903085	336	912041	298
690827	310	800610	322	903090	336	912046	298
690829	310	800611	322	903095	336	912050	298
690830	310	800612	322	903100	336	912055	298
690832	310	800613	322	910086	285	912060	298
690834	310	800614	322	910504	374	912065	298
690836	310	800615	322	910505	374	912070	298
690838	310	800616	322	910506	374	912075	298
690840	310	800617	322	910508	374	912080	298
690841	310	800618	322	910510	374	912085	298





Item ID	PAGE	Item ID	PAGE	Item ID	PAGE	Item ID	PAGE
912090	298	920214	291	920524AN	289	920714-C	290
912095	298	920216	291	920524N	288	920715-C	290
9120HD	465	920218	291	920525N	288	920716-C	290
9120RK-1	464	920220	291	920526N	288	920717-C	290
9121	250	920222	291	920527N	288	920718-C	290
912100	298	920224	291	920528N	288	920719-C	290
912105	298	920226	291	920529N	288	920721-C	290
912110	298	920228	291	920530N	288	920722-C	290
912115	298	920230	291	920532N	288	920724-C	290
912120	298	920232	291	920610AN	291	9207S12	250
912125	298	920234	291	920610N	290	921210TX-C	293
912130	298	920236	291	920611AN	291	921215TX-C	293
9123	464	920240	291	920611N	290	921220TX-C	293
9123RK	464	920242	291	920612AN	291	921225TX-C	293
9124	481	920248	291	920612N	290	921227TX-C	293
9126	250	9203N	466	920613AN	291	921230TX-C	293
920001	374	9203N1	467	920613N	290	921240TX-C	293
920002	374	920508N	288	920614AN	291	921245TX-C	293
920003	374	920510AN	289	920614N	290	921250TX-C	293
920020AN	285	920510N	288	920615AN	291	921255TX-C	293
920020N	285	920511AN	289	920615N	290	921260TX-C	293
920021AN	285	920511N	288	920616AN	291	921270TX-C	293
920021N	285	920512AN	289	920616N	290	921505-C	292
920023AN	285	920512N	288	920617AN	291	921506-C	292
920023N	285	920513AN	289	920617N	290	921508-C	292
920030AN	285	920513N	288	920618AN	291	921510-C	292
920030N	285	920514AN	289	920618N	290	921512-C	292
920036AN	285	920514N	288	920619AN	291	921514-C	292
920036N	285	920515AN	289	920619N	290	921517-C	292
920037AN	285	920515N	288	920620N	290	921519-C	292
920037N	285	920516AN	289	920621AN	291	921606	292
920060-C	285	920516N	288	920621N	290	921608	292
920112	289	920517AN	289	920622AN	291	921610	292
920114	289	920517N	467	920622N	290	921612	292
920116	289	920517N1	288	920623N	290	921614	292
920118	289	920518AN	289	920624AN	291	921616	292
920120	289	920518N	288	920624N	290	921618	292
920122	289	920519AN	289	920627N	290	921620	292
920124	289	920519N	467	920628N	290	921622	292
920126	289	920519N1	288	920629N	290	921624	292
920128	289	920520N	288	920630N	290	921814	293
920130	289	920521AN	289	920632N	290	921816	293
920132	289	920521N	467	920635N	290	921817	293
920134	289	920521N1	288	920636N	290	921818	293
920136	289	920522AN	289	920710-C	290	923090	310
920140	289	920522N	288	920712-C	290	923110	310
920212	291	920523N	288	920713-C	290	923120	310





Item ID	PAGE	Item ID	PAGE	Item ID	PAGE	Item ID	PAGE
923140	310	940176	294	940636-C	295	981507-C	288
923814	293	940224	295	940638-C	295	981508-C	288
923816	293	940226	295	940641-C	295	981510-C	288
923817	293	940228	295	940646-C	295	981512-C	288
923818	293	940230	295	940650-C	295	9850	456
9291719	292	940232	295	940732-C	296	AB200	456
9292122	292	940234	295	941519-C	296	ABS-TOP	212
930001	374	940236	295	941522-C	296	ACC300CBH01	368
930002	374	940238	295	941524-C	296	ACC35CBH01	367
930003	374	940240	295	960506-C	286	ACC50CBH01	367
930004	374	940242	295	960507-C	286	ACC50MBH01	367
9381	249	940244	295	960508-C	286	ACC70MBH01	367
9386	250	940246	295	960510-C	286	ACCSDA1412	368
940006	374	940248	295	960513-C	286	ACCSDA1414	368
940008	374	940250	295	970030	374	ACCSDA1438	368
940010	374	940252	295	970040	374	ACD01	311
940012	374	940254	295	970045	374	ALU1000-1	211
940022-C	285	940256	295	970050	374	ALU1000-4	211
940030-C	285	940258	295	970055	374	ALU12	211
940037-C	285	940260	295	980020-C	285	ALU14	211
940085-C	285	940519-C	294	980035-C	285	ALU34	211
940122	294	940521-C	294	980036A-C	285	ALU38	211
940124	294	940522-C	294	980036-C	285	ALU430	211
940126	294	940523-C	294	980060-C	285	ALU450	211
940128	294	940524-C	294	980086	285	ALUE803	210
940130	294	940527-C	294	980508-C	287	ALUE804	210
940132	294	940528-C	294	980510-C	287	ARB01	506
940134	294	940530-C	294	980511-C	287	ARB02	506
940136	294	940532-C	294	980512-C	287	ARB03	507
940138	294	940533-C	294	980513-C	287	ARBS10	504
940140	294	940534-C	294	980514-C	287	ARC80	503
940142	294	940536-C	294	980515-C	287	ARD10	501
940144	294	940538-C	294	980516-C	287	ARD13	502
940146	294	940540-C	294	980517-C	287	AREP25	506
940148	294	940541-C	294	980519-C	287	ARG01	504
940150	294	940546-C	294	980608-C	287	ARN12	505
940152	294	940550-C	294	980610-C	287	ARRC80	505
940154	294	940619-C	295	980611-C	287	ARRM38	498
940156	294	940621-C	295	980612-C	287	ARS01	502
940160	294	940622-C	295	980613-C	287	ARS02	503
940162	294	940623-C	295	980614-C	287	ARWC12	500
940164	294	940624-C	295	980616-C	287	ARWC34	500
940166	294	940627-C	295	980617-C	287	ARWC38	499
940168	294	940630-C	295	980619-C	287	ARWM11S	501
940170	294	940632-C	295	981504-C	288	ARWM12M	498
940172	294	940633-C	295	981505-C	288	ARWM38	499
940174	294	940634-C	295	981506-C	288	AT020	465



Item ID	PAGE	Item ID	PAGE	Item ID	PAGE	Item ID	PAGE
AT040	465	CC200F	491	DBX015	441	FG13100	453
AT040-SM	465	CC240F	491	DBX020	441	FG20100	453
AT080	462	CC250F	491	DBX025	441	FG20200	453
AT085	462	CMD12	487	DBX030	441	FL2506A03	356
AT090	462	CMD16	487	DBX033	441	FL2506B03	356
AT094	406	CMD20	487	DBX035	441	FL2508A03	356
AT096	406	CMD25	487	DBX040	441	FL2508B03	356
AT097	406	CMD30A	487	DBX042	441	FL2510A03	356
AT135	483	CMD40	487	DBX045	441	FL2512A03	356
AT135M	483	CMD40A	487	DBX050	441	FL2516A03	356
AT180	465	CMD80	487	DBX055	441	FL5006A03	356
AT180-S	465	CMF16	488	DBX060	441	FL5008A03	356
AT191	466	CMF16T	488	DBX065	441	FL5008B03	356
AT192	466	CMF20	488	DBX068	441	FL5010A03	356
AT194	466	CMF20T	488	DBX070	441	FL5012A03	356
AT20512	467	CMF25	488	DBX075	441	FL7006A02	356
AT20516	467	CMF25T	488	DBX080	441	FL7008A02	356
AT20520	467	CMF30	488	DBX085	441	FL7008B02	356
AT20524	467	CMF30T	488	DBX090	441	FL7010A02	356
AT330	466	CMF35	488	DBX095	441	FL8905A01	357
AT350	466	CMF35T	488	DBX100	441	FL8908A01	357
AT355	466	CMFQ20	488	DBX105	441	FLFT10	449
AT360	466	CMFQ25	488	DBX110	441	FLHF10	449
AT365	466	CMFQ40	488	DBX115	441	FLHR10	449
AT370	466	CMQ150	487	DBX120	441	FLRD10	449
AT375	466	CMQ300	487	DBX125	441	FLSQ10	449
AT380	466	CMQ450	487	DBX130	441	FLTR10	449
AT415	469	CMQ600	487	DET01	480	FTF32406005	356
AT420	469	CMQL150	487	DET01RK	480	FTF4055	348
AT605	409	CMQL300	487	DET02	480	GR25002010	358
BC408	402	CMQL450	487	DGMM	453	GR25002100	358
BC408T	402	CP04	491	DHW1300	489	GRP3000201	359
BC414	402	CP05	491	DHW1417	489	GRP3000205	359
BC414J	402	CP08	491	DHW1922	489	GRP5000201	359
BC418	402	CP50	409	DIE-HNDL	443	HBH0303	348
BC418J	402	CP52	409	DIS-SP05	474	HBH0404	348
BC424	402	CP53	410	DIS-SP05Q	474	HBH0505	348
BC424J	402	CP55	409	DM550	456	HBH0606	348
BC430	402	CP58	410	DP0810	465	HEX2500203	364
BC430J	402	CP60	410	DP0812	465	HEX2500303	364
BC436	402	CTG01	408	DP1012	465	HEX2500403	364
BC436J	402	DB028	440	DP1112	465	HEX2500503	364
BDIS-TYR	205	DB034	441	DP1314	465	HEX2500603	364
BWT406	335	DBT35	480	DP1716	465	HEX2500803	364
CALD150	452	DBT41	480	EVA-453660	213	HEX5000403	364
CALV150	452	DBT54	480	EVA-453946	213	HEX5000503	364
CC150F	491	DBX010	441	FC01	468	HEX5000603	364

Item ID	PAGE	Item ID	PAGE	Item ID	PAGE	Item ID	PAGE
HEX5000803	364	HP2038	335	M1115MM	242	M120510-C	276
HEX8900401	364	HR01	481	M120010-C	259	M1205116-C	276
HEXP3000301	364	HR01RK	481	M120010RK	259	M120511-C	276
HEXP3000305	364	HRI2	481	M120011-C	259	M1205126-C	276
HEXP3000401	364	HRI2RK	481	M120012-C	259	M120512-C	276
HEXP3000405	364	HR30R	481	M120020-C	260	M1205136-C	276
HEXP3000501	364	HR30RRK-1	481	M120020W-C	260	M120513-C	276
HEXP3000505	364	HR30RRK-2	481	M120021-C	260	M1205146-C	276
HEXP3000601	364	HR360R	481	M120021W-C	260	M120514-C	276
HEXP3000605	364	HRLN65N	482	M120022-C	260	M1205156-C	276
HEXP5000301	364	HRLN65NRK-1	482	M120022W-C	260	M120515-C	276
HEXP5000401	364	HRLR01	482	M120023-C	260	M1205166-C	276
HEXP5000501	364	HRLR01RK-2	482	M120024-C	260	M120516-C	276
HEXP5000601	364	HRLR01RK-3	482	M120030-C	260	M1205176-C	276
HMBH01	469	HRLT01	482	M120036-C	261	M120517-C	276
HMBH02	469	HRLT01RK	482	M120037-C	261	M1205186-C	276
HMBH03	469	IBA14	367	M120037M	262	M120518-C	276
HMBP12	489	ID506	375	M120040-C	463	M1205196-C	276
HMBP16	489	ID506BIT	374	M120042-C	463	M120519-C	276
HMBP24	489	ID515	375	M120046-C	463	M1205206-C	276
HMBP32	489	ID515BIT	374	M120050-C	262	M120520-C	276
HMCH08A	489	IDSE7	375	M120060-C	262	M1205216-C	276
HMCH13A	489	KP01	214	M120061-C	262	M120521-C	276
HMCH16A	489	KP02	214	M120062-C	262	M1205226-C	276
HMCH16M	490	KP03	215	M120063-C	262	M120522-C	276
HMCHM16	490	M1100	257	M120080-C	261	M1205236-C	276
HMDH35	490	M110010	257	M120112-C	277	M120523-C	276
HMDH45	490	M110020	257	M120114-C	277	M1205246-C	276
HMDH50PU	490	M110030	261	M120116-C	277	M120524-C	276
HMDH55	490	M110040	260	M120118-C	277	M1205256-C	276
HMDH60PU	490	M110050	260	M120119-C	277	M120525-C	276
HMDH65	490	M110070	259	M120120-C	277	M1205266-C	276
HMDH70PU	490	M110070RK	259	M120122-C	277	M120526-C	276
HMEG300	489	M1100-72	256	M120124-C	277	M1205276-C	276
HMEG500	489	M1100-72RK	257	M120125-C	277	M120527-C	276
HMEG800	489	M1100RK	257	M120126-C	277	M1205286-C	276
HMS1250	489	M110536	284	M120128-C	277	M120528-C	276
HMSF	490	M110541	284	M120130-C	277	M1205296-C	276
HN02	482	M110546	284	M120132-C	277	M120529-C	276
HP101	335	M110550	284	M120134-C	277	M1205306-C	276
HP102	335	M110555	284	M120136-C	277	M120530-C	276
HP103	335	M110558	284	M120138-C	277	M1205326-C	276
HP2014	335	M110560	284	M120140-C	277	M120532-C	276
HP2015	335	M110565	284	M1205086-C	276	M1205336-C	276
HP2025	335	M110570	284	M120508-C	276	M1205346-C	276
HP2026	335	M110575	284	M120509-C	276	M120534-C	276
HP2036	335	M110580	284	M1205106-C	276	M120610-C	278



Item ID	PAGE	Item ID	PAGE	Item ID	PAGE	Item ID	PAGE
M120611-C	278	M121116-C	279	M122255T-C	280	M140060M	261
M120612-C	278	M121118-C	279	M122260T-C	280	M140070	442
M1206136-C	277	M121120-C	279	M122270T-C	280	M140071	442
M120613-C	278	M1212	240	M122505-C	279	M140071RK	443
M1206146-C	277	M121220-C	281	M122506A-C	279	M140072	442
M120614-C	278	M121220T-C	280	M122506-C	279	M140072RK	443
M1206156-C	277	M121225-C	281	M122507-C	279	M14010612-C	264
M120615-C	278	M121225T-C	280	M122508A-C	279	M140106-C	264
M1206166-C	277	M121227-C	281	M122508-C	279	M14010712-C	264
M120616-C	278	M121227T-C	280	M122510-C	279	M140107-C	264
M1206176-C	277	M121230-C	281	M122510L-C	279	M14010812-C	264
M120617-C	278	M121230T-C	280	M122512-C	279	M140108-C	264
M1206186-C	277	M121240-C	281	M122514-C	279	M14010912-C	264
M120618-C	278	M121240T-C	280	M122517-C	279	M140109-C	264
M1206196-C	277	M121245-C	281	M122704-C	282	M14011012-C	264
M120619-C	278	M121245T-C	280	M122705-C	282	M140110-C	264
M120620-C	278	M121250-C	281	M122706-C	282	M14011112-C	264
M120621-C	278	M121250T-C	280	M122708-C	282	M140111-C	264
M120622-C	278	M121255-C	281	M122709-C	282	M14011212-C	264
M1206246-C	277	M121255T-C	280	M122710-C	282	M140112-C	264
M120624-C	278	M121260-C	281	M122711-C	282	M14011412-C	264
M120627-C	278	M121260T-C	280	M122712-C	282	M140114-C	264
M120630-C	278	M1212N1	236	M122713-C	282	M14011612-C	264
M120632-C	278	M1213TPX	241	M122805-C	282	M140116-C	264
M120636-C	278	M1213TX	241	M122806-C	282	M14020612-C	266
M1207	239	M121505-C	278	M122808-C	282	M140206-C	266
M120710-C	281	M121506-C	278	M122809-C	282	M14020712-C	266
M120711-C	281	M121507-C	278	M122810-C	282	M140207-C	266
M120712-C	281	M121508-C	278	M122812-C	282	M14020812-C	266
M120714-C	281	M121509-C	278	M122814-C	282	M140208-C	266
M120716-C	281	M121510-C	278	M122816-C	282	M14020912-C	266
M120718-C	281	M121512-C	278	M140012-C	259	M140209-C	266
M120720-C	281	M121514-C	278	M140012RK	259	M14021012-C	266
M120722-C	281	M121515-C	278	M140015-C	258	M140210-C	266
M120724-C	281	M121516-C	278	M140020-C	260	M14021112-C	266
M1208-6	239	M121517-C	278	M140021-C	260	M140211-C	266
M1209	241	M121518-C	278	M140022-C	260	M14021212-C	266
M1209AF	240	M121519-C	278	M140023-C	260	M140212-C	266
M1209TX	241	M1215AF	239	M140024-C	260	M14021412-C	266
M1210	240	M1215MM	239	M140030-C	260	M140214-C	266
M1211	240	M122220T-C	280	M140036-C	261	M14021612-C	266
M121106-C	279	M122225T-C	280	M140036M	262	M140216-C	266
M121107-C	279	M122227T-C	280	M140037	261	M14050412-C	263
M121108-C	279	M122230T-C	280	M140038-C	260	M1405045-C	263
M121109-C	279	M122240T-C	280	M140039	261	M140504-C	263
M121110-C	279	M122245T-C	280	M140050-C	262	M14050512-C	263
M121112-C	279	M122250T-C	280	M140060-C	262	M140505512-C	263





Item ID	PAGE	Item ID	PAGE	Item ID	PAGE	Item ID	PAGE
M1405055-C	263	M141210T-C	267	M340128-C	283	M380024-C	260
M140505-C	263	M141215T-C	267	M340130-C	283	M380030-C	260
M14050612-C	263	M141220T-C	267	M340132-C	283	M380035-C	261
M140506-C	263	M141225T-C	267	M340134-C	283	M380036-C	261
M14050712-C	263	M141227T-C	267	M340136-C	283	M380036M	262
M140507-C	263	M141230T-C	267	M340138-C	283	M380037	261
M14050812-C	263	M141240T-C	267	M340140-C	283	M380039-C	463
M140508-C	263	M141300-C	266	M340142-C	283	M380040-C	463
M14050912-C	263	M141301-C	266	M340144-C	283	M380041-C	463
M140509-C	263	M141302-C	266	M340146-C	283	M380042-C	463
M14051012-C	263	M141303-C	266	M340148-C	283	M380046-C	463
M140510-C	263	M1413N1	222	M340152-C	283	M380047-C	463
M14051112-C	263	M141404-C	266	M340156-C	283	M380050-C	262
M140511-C	263	M1414055-C	266	M340158-C	283	M380060-C	262
M14051212-C	263	M141407-C	266	M340160-C	283	M380061-C	262
M140512-C	263	M141503-C	267	M340164-C	283	M380110-C	269
M14051312-C	263	M141504-C	267	M3405196-C	283	M38011212-C	269
M140513-C	263	M1415055-C	267	M3405216-C	283	M380112-C	269
M140604-C	265	M141505-C	267	M3405226-C	283	M38011412-C	269
M1406055-C	265	M141506-C	267	M3405246-C	283	M380114-C	269
M140605-C	265	M141507-C	267	M3405266-C	283	M38011612-C	269
M14060612-C	265	M141508-C	267	M3405276-C	283	M380116-C	269
M140606-C	265	M141510-C	267	M3405306-C	283	M38011812-C	269
M14060712-C	265	M141512-C	267	M3405326-C	283	M380118-C	269
M140607-C	265	M141601-C	267	M3405336-C	283	M38012012-C	269
M14060812-C	265	M141602-C	267	M3405346-C	283	M380120-C	269
M140608-C	265	M141603-C	267	M3405366-C	283	M38012212-C	269
M14060912-C	265	M340020-C	260	M3405386-C	283	M380122-C	269
M140609-C	265	M340020S-C	260	M3405416-C	283	M38012412-C	269
M14061012-C	265	M340021-C	260	M3405466-C	283	M380124-C	269
M140610-C	265	M340021S-C	260	M3405506-C	283	M380126-C	269
M14061112-C	265	M340022-C	260	M341514-C	284	M380128-C	269
M140611-C	265	M340022S-C	260	M341517-C	284	M38021212-C	271
M14061212-C	265	M340030-C	260	M341519-C	284	M380212-C	271
M140612-C	265	M340050-C	262	M341522-C	284	M38021412-C	271
M14061312-C	265	M340050S-C	262	M380010A-C	259	M380214-C	271
M140613-C	265	M340070-C	259	M380011-C	259	M38021612-C	271
M1407	228	M340070RK	259	M380012-C	259	M380216-C	271
M140704-C	267	M340070S-C	259	M380012RK	259	M38021812-C	271
M140705-C	267	M340070SRK	259	M380015-C	258	M380218-C	271
M140706-C	267	M3400-72	256	M380020-C	260	M38022012-C	271
M140707-C	267	M340072E	256	M380020W-C	260	M380220-C	271
M140708-C	267	M3400-72RK	257	M380021-C	260	M38022212-C	271
M1408TX	228	M340085-C	261	M380021W-C	260	M380222-C	271
M1409HN	228	M340085M	262	M380022-C	260	M38022412-C	271
M1410T5	369	M340086-C	261	M380022W-C	260	M380224-C	271
M1412	228	M340124-C	283	M380023-C	260	M380226-C	271



Item ID	PAGE	Item ID	PAGE	Item ID	PAGE	Item ID	PAGE
M380228-C	271	M38061512-C	270	M381230T-C	274	M382512-C	273
M380507-C	268	M380615-C	270	M381240-C	275	M382704-C	274
M38050812-C	268	M38061612-C	270	M381240T-C	274	M382705-C	274
M380508-C	268	M380616-C	270	M381245-C	275	M382706-C	274
M38050912-C	268	M38061712-C	270	M381245T-C	274	M382708-C	274
M380509-C	268	M380617-C	270	M381250-C	275	M382709-C	274
M38051012-C	268	M38061812-C	270	M381250T-C	274	M382710-C	274
M380510-C	268	M380618-C	270	M3812N1	229	M386510-C	310
M38051112-C	268	M38061912-C	270	M3813TPX	234	M386511-C	310
M380511-C	268	M380619-C	270	M3813TX	234	M386512-C	310
M38051212-C	268	M38062012-C	270	M3814	235	M386513-C	310
M380512-C	268	M380620-C	270	M381503BL-C	273	M386514-C	310
M38051312-C	268	M38062112-C	270	M381503-C	272	M386515-C	310
M380513-C	268	M380621-C	270	M381504BL-C	273	M386516-C	310
M38051412-C	268	M38062212-C	270	M381504-C	272	M386517-C	310
M380514-C	268	M380622-C	270	M3815055BL-C	273	M386518-C	310
M38051512-C	268	M3807	233	M3815055-C	272	M386519-C	310
M380515-C	268	M380710-C	275	M381505BL-C	273	MB410	406
M38051612-C	268	M380712-C	275	M381505-C	272	MB412	406
M380516-C	268	M380714-C	275	M381506BL-C	273	MB416	406
M38051712-C	268	M380716-C	275	M381506-C	272	MB441-5	400
M380517-C	268	M380718-C	275	M381507BL-C	273	MB441-5T	400
M38051812-C	268	M3808MM	235	M381507-C	272	MB441-6	400
M380518-C	268	M3809	233	M381508BL-C	273	MB441-6T	400
M38051912-C	268	M3809HBN	234	M381508-C	272	MB442-5	400
M380519-C	268	M3809TX	235	M381510BL-C	273	MB442-6	400
M380520-C	268	M3811	234	M381510-C	272	MB442-6T	400
M380521-C	268	M381103-C	274	M381512BL-C	273	MB442-7	400
M38052212-C	268	M381104-C	274	M381512-C	272	MB442-7S	400
M380522-C	268	M381105-C	274	M3816	233	MB442-8	400
M3806	235	M381106-C	274	M382210T-C	275	MB442-8T	400
M38060712-C	270	M381107-C	274	M382215T-C	275	MB444-10	401
M380607-C	270	M381108-C	274	M382220T-C	275	MB444-6	401
M38060812-C	270	M381110-C	274	M382225T-C	275	MB444-8	401
M380608-C	270	M381112-C	274	M382227T-C	275	MB444-8T	401
M38060912-C	270	M3812	233	M382230T-C	275	MB445-10	401
M380609-C	270	M381210-C	275	M382240T-C	275	MB448-6	403
M38061012-C	270	M381210T-C	274	M382245T-C	275	MB448-8	403
M380610-C	270	M381215-C	275	M382250T-C	275	MB449-10	404
M38061112-C	270	M381215T-C	274	M382503-C	273	MB449-11	404
M380611-C	270	M381220-C	275	M382504-C	273	MB449-9	404
M38061212-C	270	M381220T-C	274	M3825055-C	273	MB451-7	404
M380612-C	270	M381225-C	275	M382505-C	273	MB451-8	404
M38061312-C	270	M381225T-C	274	M382506-C	273	MB452-6	404
M380613-C	270	M381227-C	275	M382507-C	273	MB452-6T	404
M38061412-C	270	M381227T-C	274	M382508-C	273	MB452-7	404
M380614-C	270	M381230-C	275	M382510-C	273		



Item ID	PAGE	Item ID	PAGE	Item ID	PAGE	Item ID	PAGE
MB452-7T	404	MBE470-5	413	MD7030HNN	347	MD930N	345
MB452-8	404	MBE470-7	413	MD7040HBN	348	MD930TN	347
MB452-8T	404	MBE470-9	413	MD7050HBN	348	MD931N	345
MB452-9	404	MBE471-5	413	MD7060HBN	348	MD932N	345
MB461-5	404	MBE471-7	413	MD7080HBN	348	MD932N1	345
MB461-6	404	MBE471-9	413	MD801N	348	MD934N	345
MB461-6T	405	MBE472-5	413	MD802N	348	MD935N	345
MB461-8	404	MBE472-7	413	MD803N	348	MD940N	346
MB461-8T	405	MBE472-9	413	MD901	348	MD940N1	346
MB463-5	405	MBE473-5	414	MD9053N	350	MD940TN	347
MB463-6	405	MBE473-7	414	MD906N	352	MD945TN	347
MB463-8	405	MBE473-9	414	MD906N3	352	MD947N	346
MB463-8T	405	MBH114	367	MD906TN	347	MD947N1	346
MB464-6	405	MBM441	410	MD907FL	376	MD948N	346
MB464-6T	406	MBM449	410	MD907TN	347	MD948N1	346
MB465-6	406	MBM461	411	MD908TN	347	MD948N2	346
MB470-5	414	MBM464	411	MD909TN	347	MD948N3	346
MB470-7	414	MBM467	411	MD910N	351	MD948N4	346
MB470-9	414	MBM468	411	MD910TN	347	MD948N5	346
MB471-5	414	MBM469	412	MD911N	351	MD948N6	346
MB471-7	414	MBV441-6	426	MD912N	352	MD948N8	346
MB471-9	414	MBV442-8	426	MD914N	345	MD949N	346
MB472-5	414	MBV444-8	427	MD915N	345	MD950N	346
MB472-7	414	MBV451-7	426	MD915N1	345	MD952N	346
MB472-9	414	MBV451-8	426	MD915TN	347	MD952N1	346
MB473-5	415	MBV461-8	426	MD916N	345	MD953N	346
MB473-7	415	MBV463-8	427	MD916N1	345	MD954N	346
MB473-9	415	MBV482-10Q	427	MD916N2	345	MD960N	346
MB481-10	407	MBV499-7	427	MD917N	345	MD961N	346
MB481-10Q	407	MD193	376	MD917N1	345	MD961N1	346
MB481-10T	407	MD216	376	MD917N2	345	MD961N2	346
MB481-10TQ	408	MD503N	462	MD920N	345	MD962N	346
MB481-7	407	MD503NA	462	MD920N1	345	MD962N1	346
MB481-7T	407	MD503ND	462	MD920TN	347	MD962N2	346
MB482-10Q	407	MD514L	258	MD922N	345	MD962N3	346
MB482-10TQ	408	MD514N	258	MD923N	345	MD962N4	346
MB482-12Q	407	MD610TPN	347	MD923N1	345	MD962N4A	346
MB482-12Q	408	MD615TPN	347	MD925TN	347	MD962N4C	346
MB482-7Q	407	MD620TPN	347	MD927TN	347	MD962N4D	346
MB483-10	337	MD625TPN	347	MD928N	345	MD962N5	346
MB483-7	337	MD627TPN	347	MD928N1	345	MD963N	346
MB489-7	403	MD630TPN	347	MD928N2	345	MD964N	346
MB489-8	403	MD640TPN	347	MD928N3	345	MDA180	460
MB499-7T	409	MD7020HBN	348	MD928N4	345	MDA-R	460
MB541-5	403	MD7020HNN	347	MD928N5	345	MDBH	376
MB541-6	403	MD7025HBN	348	MD928N6	345	MDH-L	460
MB541-7	403	MD7030HBN	348	MD928N7	345	MDH-S	460





Item ID	PAGE	Item ID	PAGE	Item ID	PAGE	Item ID	PAGE
MDM700	343	MDP90	460	MDV862N	423	MV380020	428
MDM706	343	MDQ147	377	MDV864N	423	MV380021	428
MDM706TX	344	MDQ183	377	MDV864NF	423	MV380506	429
MDM706TXT	343	MDQ217	377	MDV866N	423	MV380507	429
MDM711	342	MDR06	461	MDV906N	425	MV380508	429
MDM712	342	MDR08	461	MDV909N	425	MV380509	429
MDM713	342	MDR908	378	MDV9855	456	MV380510	429
MDM714	342	MDR908S	378	MH75	487	MV380511	429
MDM715	342	MDR915	378	MH90	487	MV380512	429
MDM716	342	MDRQ908	379	MIR25	452	MV380513	429
MDM717	342	MDRT908	378	MKV709	429	MV380514	429
MDM718	342	MD-SCR	460	MKV709A	429	MV380515	429
MDM806	342	MDT932N	349	MP1400	311	MV380516	429
MDM806T	344	MDT934N	349	MP2700	311	MV380517	429
MDM807	342	MDT935N	349	MP91500	312	MV380518	429
MDM807T	344	MDT952N	349	MP91500RK	312	MV380519	429
MDM808	342	MDT953N	349	MPSL01	312	MV380520	429
MDM808T	344	MDTHQ	377	MPSL02	312	MX04	262
MDM809	342	MDV700	424	MPV600507	430	NS02	475
MDM809T	344	MDV710	424	MPV600508	430	NS02RKL	475
MDM810	342	MDV724N	422	MPV600509	430	NS02RKS	475
MDM810T	344	MDV726N	422	MPV600510	430	NS45108M	366
MDM815	342	MDV731	425	MPV600511	430	NS45506M	366
MDM815T	344	MDV732	425	MPV600512	430	NS45507M	366
MDMC715N	345	MDV733	425	MPV600513	430	NS45508M	366
MDN505	349	MDV734	425	MPV600514	430	NS45508R	366
MDN5055	349	MDV742N	422	MPV600515	430	NSP65108	366
MDN506	349	MDV744N	422	MPV600516	430	NSP65507	366
MDN507	349	MDV751	425	MPV600517	430	NSP65508	366
MDN508	349	MDV752	425	MPV600518	430	NSP65510	366
MDN510	349	MDV762N	423	MPV600519	430	NSP65513	366
MDN511	349	MDV764N	423	MPV600520	430	O9100115	286
MDN512	349	MDV771	425	MPV600521	430	O910075	286
MDN513	349	MDV772	425	MPV600522	430	O92194	286
MDNT405	350	MDV802N	423	MPV600523	430	O92244	286
MDNT4055	350	MDV820N	422	MPV600524	430	O95034	286
MDNT406	350	MDV822N	422	MR500	350	O95036	286
MDNT407	350	MDV823N	422	MRP06	461	O95046	286
MDNT408	350	MDV824N	422	MRP95	461	O95775	286
MDNT409	350	MDV826N	422	MT03	454	O97043	286
MDNT410	350	MDV828N	422	MT03MM	454	O97045	286
MDNT411	350	MDV840N	422	MT05	454	O97051	286
MDNT412	350	MDV842N	422	MT05MM	454	P90433	286
MDNT413	350	MDV844N	422	MT08	454	P90435	286
MDNT414	350	MDV844NF	423	MT08MM	454	P90445	286
MDP125	461	MDV846N	422	MT15	455	P90543	286
MDP35	461	MDV860N	423	MV3800	428	P90545	286





Item ID	PAGE	Item ID	PAGE	Item ID	PAGE	Item ID	PAGE
P90551	286	PM14	254	ROB2500203	365	SLM0400	455
P906110	286	PP03	491	ROB2500303	365	SLM0600	455
P90675	286	PP04	491	ROBP3000101	366	SLM1000	455
P92320	286	PP05	491	ROBP3000105	366	SLM1200	455
P92325	286	PP06	491	ROBP3000201	366	SLP3160	412
PB12	477	PP07	491	ROBP3000205	366	SLP3180	412
PB12A	477	PP08	491	ROBP5000101	366	SLT01	455
PB16	477	PPS06	492	ROBP5000201	366	SP11	472
PB18A	477	P-SC01	495	ROBP5000301	366	SP1410	473
PB20	477	P-SC02	495	ROBP8900101	366	SP1410Q	473
PB22A	477	P-SC03	495	ROBP8900201	366	SP1810	473
PCCAP	492	PT3810R	258	ROBP8900301	366	SP1810Q	473
PCX05	492	P-UKF	445	SC01	35	SP22	472
PF380	477	PWC12	337	SC02	35	SP2215	473
PGW1719	334	PWC14	337	SC03	36	SP2215Q	473
PGW1922	334	PWC18	337	SC04	36	SP2615	473
PGW1924	334	PWC24	337	SC04E	37	SP2615Q	473
PGW2124	334	PWC36	337	SCE1	116	SP31410	473
PGW2430	334	PZZ500103	359	SCE2	117	SP31410Q	473
PGW2730	334	PZZ500110	359	SCE3	117	SP31810	473
PH2500103	357	PZZ500203	359	SCE4	118	SP31810Q	473
PH2500110	357	PZZ500210	359	SCE5	118	SP32215	473
PH2500203	357	PZZ500303	359	SCP01	491	SP32215Q	473
PH2500210	357	PZZ500310	359	SCPS01	50	SP32615	473
PH2500303	357	PZ5000103	359	SCPS01E	50	SP32615Q	473
PH2500310	357	PZ5000203	359	SCR01	482	SP3320	473
PH5000103	357	PZ5000303	359	SCR02	482	SP3320Q	473
PH5000203	357	PZ7000102	360	SD501	484	SP33320	473
PH5000303	357	PZ7000202	360	SE05	475	SP33320Q	473
PH7000102	358	PZ8900101	360	SE141	474	SPA11	472
PH7000202	358	PZ8900201	360	SE142	474	SPA22	472
PH8900101	358	PZP3000101	360	SE143	474	SPBP20	463
PH8900201	358	PZP3000105	360	SEL01S	474	SQAA200	457
PHF0365	348	PZP3000201	360	SEL02S	474	SQAA250	457
PHH0102	348	PZP3000205	360	SEL03S	474	SQAA300	457
PHH32000305	357	PZP3000301	360	SEL04S	474	SQAB10070	457
PHH32010205	357	PZP3000305	360	SEL05S	474	SQAB150100	457
PHP3000101	358	PZP5000101	360	SG713	494	SQAB200130	457
PHP3000105	358	PZP5000201	360	SG713G	495	SQAB300175	457
PHP3000201	358	PZP5000301	360	SG960	493	SQAC300	457
PHP3000205	358	PZP8900201	360	SG960A	494	SR1180	437
PHP3000301	358	PZZ0102	348	SG960G	494	SR2180	437
PHP3000305	358	PZZ32000305	359	SG960Y	494	SR3160	437
PHP5000101	358	PZZ32010205	359	SL01	468	SSH01	492
PHP5000201	358	QC114	367	SL02	468	SSH02	493
PHP5000301	358	RHA14	254	SL03	468	SSH03	493
PHP8900201	358	ROB2500103	365	SLM0300	455	SSH04	493



Item ID	PAGE	Item ID	PAGE	Item ID	PAGE	Item ID	PAGE
ST12319	476	T9222	247	TCA08	207	TC-S01	216
ST12321	476	T9222L	248	TCATP	207	TC-S02	216
ST12322	476	T9240	248	TCATV	207	TC-S03	217
ST12324	476	T9417	248	TCAV4	488	TC-S03AL	217
ST12325	476	T9417L	249	TCB135	219	TC-S03AR	217
ST12506-C	476	T9421LAF	249	TCB180	219	TC-S04	217
ST12508-C	476	T9423AF	249	TCB80	219	TCSB	202
ST12510-C	476	TAP-HNDL	443	TC-BKEY	210	TCSB16	203
ST12512-C	476	TBSKT07	272	TCC02	212	TC-SC	201
ST200	453	TBSKT08	272	TCC03	212	TC-SL01	216
ST38112	476	TBSKT10	272	TCCH	208	TC-SL02	216
ST38116	476	TBSKT12	272	TC-COVER	204	TC-SL03AL	217
ST38122	476	TBSKT13	272	TC-COVER1	203	TC-SL03AR	217
ST38306	476	TBSKT14	272	TCCTH	208	TCSMC	218
ST38308	476	TBSKT17	272	TCDIVL	205	TCT01	212
ST38310	476	TBSKT19	272	TCDIVS	204	TCT02	212
ST38311	476	TBUSP14	463	TCDRK	209	TCT03	212
ST38312	476	TBUSP16	463	TCDSH	210	TCT04	212
ST38313	476	TBUSP21	463	TCF01	205	TC-TB01	213
ST38314	476	TBW10	272	TCF02	205	TC-TB02	213
ST38316	476	TC-160UR	216	TCF03	205	TC-TB03	213
ST38317	476	TC-180CLOCK	209	TCF04	205	TC-TB05	213
STMM1150	453	TC-180KEYLOCK	209	TCF05	205	TC-TB06	213
T1220AF	236	TC187	173	TCF06	205	TC-TB07	213
T1221	236	TC-4	201	TCF07	205	TC-TB08	213
T1221-6	237	TC450	202	TC-FB01	216	TC-TBS02	213
T1234	237	TC-4SBL	201	TC-FB02	216	TC-TBS04	213
T1244	238	TC540	203	TC-FB03	216	TCTMC	218
T1268	238	TC-540W	210	TC-H01	216	TC-UPRL	216
T1408	224	TC-6T	202	TC-H02	216	TC-UPRLS	216
T1422	224	TC-6T01	37	TC-H05	216	TC-UPRR	216
T1423	225	TC-6T02	38	TC-LBK	216	TC-UPRRS	216
T1424	225	TC-6TE01	119	TC-LEG	216	TCW707EV	199
T1424S	226	TC-6TE02	119	TC-LOCK3	210	TCW907X	200
T1435AF	226	TC-6TE03	120	TC-LOCK5	210	TC-WC02	203
T1436	227	TC-6TE04	120	TC-MAG	209	TCW-HK02	211
T1460	227	TC-6TE05	121	TC-MAG1	208	TCW-HK03	211
T3418-6	242	TC-6TE06	121	TC-MAT	204	TCW-HK10	211
T3834	229	TC803SV	199	TCMME179	116	TCW-HK45	211
T3835AF	230	TC804EV	198	TCNBC	210	TCW-HK90	211
T3839	230	TC805SV	198	TC-NKEY	210	TCWIQ-SC	210
T3840	231	TC-90CLOCK	209	TCP445C	202	TCWPRK	210
T3848	231	TC-90KEYLOCK	209	TC-PA01	216	TCW-SP	211
T3867	232	TCA01	207	TC-PA02	216	TCW-SP01	210
T9206	247	TCA05	204	TC-PA03	216	TCW-SW	210
T9218AF	247	TCA06	214	TCPRK	209	TDD03050	442
T9218LAF	247	TCA07	214	TCRFH	210	TDD04070	442

Item ID	PAGE	Item ID	PAGE	Item ID	PAGE	Item ID	PAGE
TDD05080	442	TEDCT06	167	TEXRF03	131	TJ1429	371
TDD06100	442	TEDDF7	150	TEXRL03	132	TJ1430	42
TDD08125	442	TEDHEX7	157	TEXTB05	168	TJ1430	372
TDD10150	442	TEDHT42	157	TEXW05	168	TJ149	43
TDD12175	442	TEDIMM	167	TEZ01	126	TJNS05	42
TDT03050	442	TEDLBS17	135	TEZMD06	152	TJNS05	373
TDT04070	442	TEDPC14	168	TEZSD02	145	TJSE05S	43
TDT05080	442	TEDSD14	144	TEZSN06	169	TJSE05S	475
TDT06100	442	TEDTX7	157	TEZVCG03	158	TKP26R16	173
TDT08125	442	TEDV3818	165	TF22	477	TKS26B1033T	19
TDT10150	442	TEDV440	164	TF2230RK	477	TKS26R1033T	17
TDT12175	442	TEDV909N	162	TF30	477	TKS26R1034T	21
TEA01	125	TEDVMB08	164	TF300	479	TKS26R418F	105
TEA02	125	TEDVSP12	166	TF300RK	479	TKS26R528F	107
TEA1487	132	TEFMB7	126	TF76	478	TKS26R702F	109
TEA7203	132	TEFMBP7	126	TF76RK	478	TKS26R753T	23
TEA9214LAF	142	TEFMBP7E	127	TFA0252RK	480	TKS53R1133F	103
TEA9216AF	142	TEFMBV07	165	TFA10	480	TKS53R1295T	15
TEABS50	156	TEFMD54	154	TFA12	480	TKT26R137T	34
TEAHR81	169	TEFMDI54	155	TFA15	480	TKW26R278F	115
TEAMD04N	151	TEFMDV12	162	TFA22	480	TKW26R335F	114
TEAMD04N1	151	TEFMDV15	163	TFP01	478	TKW26R516T	32
TEAMD04TXN	151	TEFSK44	136	TFP01RK	478	TKW26R628T	33
TEAMDQ78	156	TEFSK57	136	TFP02	479	TKW37B1008T	27
TEAMDV04N	161	TEFSKV19	167	TFP02RK	479	TKW37R521F	113
TEAMDV04N1	162	TEFSPV17	167	TGMMUNC	453	TKW37R595T	31
TEAMDV10	161	TEFX06	128	THBS22	370	TKW37R637F	111
TEASD38	145	TEFX06E	128	THBSI22	370	TKW37R663T	29
TEASR04A	169	TEFX07	128	T-HD	263	TKW53R615T	25
TEAVSD09	145	TEFX07A	128	T-HD01	272	TM080	232
TED00	125	TEFXV11	163	THDV105	172	TM095	243
TED01	125	TEFXV17	164	THDV105E	172	TM106	244
TED1227	135	TEFXV27	166	TJ028	43	TM111	245
TED1489	134	TEFXV28	166	TJ028	371	TM127	246
TED3836	134	TEX02	126	TJ1412	124	TM708	343
TED441Q	157	TEX1238	146	TJ1412	372	TORP01A	313
TED441-T	158	TEX2032	147	TJ1413	124	TORP01E	313
TED441-TQ	158	TEX3403	137	TJ1413	373	TORP01U	313
TED6512R	147	TEX3410	137	TJ1414	124	TORQ	313
TED6512RS	147	TEX6308	147	TJ1414	373	TORQ02	312
TED6515	146	TEX915N	152	TJ1415	45	TORQ02A	312
TED8012	146	TEXBR03	131	TJ1415	222	TORQ02U	312
TED909TXN	152	TEXEXTI3	137	TJ1419	44	TORQ03	312
TED911N	151	TEXFLS06	148	TJ1419	223	TORQ03A	312
TED9121	142	TEXMDTN	155	TJ1420	44	TORQ03U	312
TEDADJ4	150	TEXMPI2	146	TJ1420	223	TORQ04	312
TEDBS47	135	TEXPB4	168	TJ1429	42	TORQ04A	312





Item ID	PAGE	Item ID	PAGE	Item ID	PAGE	Item ID	PAGE
TORQ04U	312	TSW26R6L	190	TT804	96	TTEMD98N	153
TORQ05	312	TSW26R7	191	TT9015HX	64	TTEPSI2	129
TORQ05A	312	TSW26R9	192	TT9024	62	TTEPSI5	129
TORQ05U	312	TSW37B8	193	TT9116N	63	TTEPS25	127
TORQ99A	312	TSW37R7	193	TT9120DN	64	TTESK126	140
TORQ99E	312	TSW53R9	194	TT917N	75	TTESK25	138
TORQ99U	312	TSW64R15	195	TT917TXN	75	TTESK32	139
TORQA	313	TT00	46	TT9207	62	TTESK63	138
TORQS01	313	TT01	46	TT9207A	63	TTESK67	141
TORQU	313	TT02	46	TT9212	63	TTESK77	140
TPM01	218	TT03	46	TT9212TX	64	TTESK85	141
TPM02	218	TT04	47	TTADJ04	74	TTESK86	139
TPT01	174	TT1205	56	TTADP17	61	TTESP28	131
TPX2501003	363	TT1211	56	TTAF32	52	TTESP31	148
TPX2501503	363	TT1215AF	57	TTAF3212	53	TTESP31A	148
TPX2502003	363	TT1217	56	TTALU	45	TTESP37	148
TPX2502503	363	TT1217-6	56	TTBE18	96	TTEVG11	161
TPX2502703	363	TT1218	57	TTBM	92	TTEX17	131
TPX2503003	363	TT1218-6	57	TTBS35	55	TTEX18	130
TPX2504003	363	TT1236	69	TTBS53	81	TTEX219	130
TQAG	311	TT1435	51	TTCP04	97	TTEX23N	158
TQS018	311	TT143512	52	TTCP121	97	TTEX32	148
TQS042	311	TT1448	53	TTD00	47	TTHC03	93
TQS055	311	TT3592	69	TTD01	47	TTHEX16	57
TQS065	311	TT3816	54	TTD02	47	TTHEX23	58
TRC1012	463	TT381612	54	TTD441	84	TTHEX7	81
TRC1418	463	TT3819	54	TTD441Q	85	TTHEX7AF	82
TSC15R1	200	TT381912	54	TTD441-T	84	TTHEX7S	81
TSC15R1D	201	TT440	83	TTD912TXN	76	TTHP08	74
TSC15R7	200	TT440Q	83	TTD914N	75	TTHR81	98
TSC8R1D	201	TT440-T	83	TTD9416	65	TTHT28	82
TSM26B3	188	TT440-TQ	83	TTDB28	91	TTID19	66
TSM26R3	188	TT474-5	85	TTDCM	93	TTID20	65
TSS26B16	196	TT474-5E	85	TTDCT05	89	TTK40	90
TSS26R16	196	TT474-7	86	TTDCT06	90	TTMD12D	76
TSS37R12	197	TT474-7E	86	TTDTD34	91	TTMD74	79
TSS53R19	197	TT6010M	69	TTDV910N	88	TTMD74-1	368
TST11R2	185	TT6010MRS	72	TTEAF62	149	TTMD74-2	368
TST26B4	186	TT6208	73	TTEISK33	144	TTMDP	93
TST26B4P	187	TT6506	73	TTEISK73	143	TTMDQ38	79
TST26R4	186	TT6508R	70	TTEMB11	159	TTMDQ49	77
TST26R5F	187	TT6508RAF	71	TTEMB13Q	160	TTMDQ76	77
TST37R5F	189	TT6508RF	71	TTEMB14Q	160	TTMDR84	78
TST53R10F	189	TT6508RS	71	TTEMB17	159	TTMDRT64	80
TSW26B9	192	TT6511R	71	TTEMD115N	132	TTM116	76
TSW26R4L	190	TT6511RS	72	TTEMD122N	153	TTNF12	92
TSW26R6	191	TT8012	68	TTEMD33	154	TTNF12-01	447



Item ID	PAGE	Item ID	PAGE	Item ID	PAGE	Item ID	PAGE
TTNF12-02	447	TTX02	48	TWB-155Q	215	TXP3003005	362
TTNF12-03	447	TTX03	48	TWB-15TOP	215	TXP3004001	362
TTNF12-04	447	TTX1292	67	TWB2000	215	TXP3004005	362
TTNF12-05	447	TTX2032	69	TWB-2000A	215	TXP5001001	362
TTNF12-06	447	TTX2436	70	TWB-20SQ	215	TXP5001501	362
TTNF12-07	448	TTX2493	68	TWB-20TOP	215	TXP5002001	362
TTNF12-08	448	TTX2640	70	TWB-4WD	215	TXP5002501	362
TTNF12-09	448	TTX3402E	60	TWB-LEG	215	TXP5002701	362
TTNF12-10	448	TTX3404	60	TWB-PA	215	TXP5003001	362
TTNF12-11	448	TTX3404S	60	TWB-UPR	216	TXP5004001	362
TTNF12-12	448	TTX3414	60	TX2500603	361	TXP8902001	362
TTNR81	98	TTX34AF	61	TX2500703	361	TXP8902501	362
TTOS16	94	TTX3892	67	TX2500803	361	TXP8903001	362
TTPC09	99	TTX474-9	86	TX2500903	361	TXX1015	348
TTPS09	49	TTX474-9E	86	TX2501003	361	TXX2025	348
TTPS09E	49	TTX6311	72	TX2501503	361	TXX3040	348
TTPSAD	95	TTX6607	72	TX2502003	361	TXX32101505	360
TTPSPG	87	TTX6707	73	TX2502503	361	TXX32202505	360
TTRORS	74	TTX918N	75	TX2502703	361	WR8012	174
TTRS15	59	TTX9415	65	TX2503003	361	WRDF06	175
TTSD38	66	TTXBR03	50	TX2504003	361	WRFL05	178
TTSN11	96	TTXEXT13	59	TX5000803	361	WRFLS05	175
TTSR04	93	TTXF05	92	TX5001003	361	WRHEX07	176
TTSR04A	99	TTXFLS06	73	TX5001503	361	WRHEX07AF	176
TTSS07	94	TTXLMP12	70	TX5002003	361	WRMB04	177
TTTC06	97	TTXMB02	85	TX5002503	361	WRMBV04	178
TTTD17	91	TTXMD41N	80	TX5002703	361	WRMD10N	176
TTTF10	95	TTXMDTN	76	TX5003003	361	WRMDT05N	176
TTTHQ62	78	TTXMP12	68	TX7001002	361	WRMDV05N	177
TTTJ04	45	TTXND	82	TX7001502	361	WRMDV07N	177
TTTM03	98	TTXPI292	68	TX7002002	361	WRPC10	178
TTTM08	98	TTXPB3	96	TX7002502	361	WRSP12	174
TTTS08	64	TTXPB3A	97	TX8901001	362	WRSP12LMP	175
TTTX18	58	TTXQRS07	74	TX8902001	362	WRSP12RS	175
TTTX23	58	TTXRF03	51	TX8902501	362	WRTX07	177
TTTX30	55	TTXRL03	50	TX8903001	362		
TTTX7	82	TTXTB05	95	TXP3001001	362		
TTTXH15	58	TTXTB09	95	TXP3001005	362		
TTV3814	89	TTZ01	49	TXP3001501	362		
TTV440	89	TTZVG03	87	TXP3001505	362		
TTV706N	88	TV18N	428	TXP3002001	362		
TTV710N	88	TW1180	412	TXP3002005	362		
TTV907N	88	TW2125	412	TXP3002501	362		
TTVG05	87	TW2160	412	TXP3002505	362		
TTVSD09	89	TW2180	413	TXP3002701	362		
TTX00	48	TWB1500	215	TXP3002705	362		
TTX01	48	TWB-1500A	215	TXP3003001	362		



**TENGTTOOLS®**



